

DACORUM

URBAN DESIGN ASSESSMENT

HEMEL HEMPSTEAD



**Final Report
January 2006**

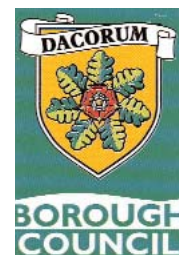

urban
practitioners



CONTENTS

1. INTRODUCTION	3
2. URBAN DESIGN GUIDELINES and CASE STUDIES	4
3. HEMEL HEMPSTEAD - TODAY	5
3. HEMEL HEMPSTEAD - HISTORY	8
4. STRATEGY PLAN AND SETTLEMENT PRINCIPLES	10
5. URBAN DESIGN ZONES	14
6. URBAN DESIGN GUIDELINES	15
7. URBAN DESIGN ASSESSMENT	30
MAKING PLACES	30
CONTINUITY AND ENCLOSURE	40
MAKING CONNECTIONS	45
QUALITY OF THE PUBLIC REALM	50
LEGIBILITY	53
8. KEY ISSUES, SENSITIVITIES, CAPACITIES AND OPPORTUNITIES	56
9. CONSULTATION WORKSHOP	64



INTRODUCTION

The Hemel Hempstead Urban Design Assessment final report is structured into nine sections.

'Hemel Hempstead - Today' describes the town's basic characteristics, including location, transport connections, population and social composition. The policy context summarises policy issues pertinent only to Hemel Hempstead that have not been covered in the borough-wide document. 'Hemel Hempstead - History' provides the historical context to the assessment.

STRATEGY PLAN and SETTLEMENT PRINCIPLES

The Strategy Plan and Settlement Principles lays out broad principles in both planimetric and text form which characterise the four Urban Design zones and sets out principles for circulation, views and legibility.

URBAN DESIGN ZONES

The Urban Design zones section defines the areas associated with each Urban Design zone and identifies the 'ideal norm' for each zone. The Hemel Hempstead Urban Design zones have been created on the basis of existing characteristics, reflecting the morphology, density and typologies of each area, *and* an understanding of how these areas should be viewed in light of any potential development or regeneration of the zone. The norm, shown as a cropped portion of the zone and as a section, demonstrate the ideals for that zone in terms of such Issues as building heights, setbacks, typology, morphology and densities.

URBAN DESIGN ASSESSMENT

The Urban Design Assessment provides the baseline evidence and analysis which has shaped the strategy plan, settlement principles and urban design guidelines. The assessment follows the criteria described in the borough-wide report. Please note that the maps contained within this report are not to scale.

OPPORTUNITIES, SENSITIVITIES and CAPACITIES

The Key Opportunities, Sensitivities and Capacities section summarises the issues that emerged from the baseline evidence and analysis.

CONSULTATION WORKSHOP

The Consultation Workshop summary encapsulates the results of the Hemel Hempstead stakeholder workshop. Many of the stakeholder comments have been used as evidence in the urban design assessment.

URBAN DESIGN GUIDELINES and CASE STUDIES

The Urban Design Guidelines have been created on the basis of each Urban Design zone. The guidelines have been developed following the Urban Design Assessment criteria described in the borough-wide report, although circulation, views and legibility have been addressed under the settlement-wide principles.

Case Studies

The case studies apply the various classifications of the guidelines to create a range of recommended possibilities for each Urban Design zone. Depending on the zone, case studies may suggest applying 'typical' conditions, 'enhanced density' conditions, or 'increased density' conditions relative to the surrounding character. The case study drawings which follow each zone's guidelines are illustrative only, particularly with regards to car parking or amenity space.

Both the guidelines and case studies dedicated to each zone are divided into two categories, **infill** and **block** sites. A block site is considered to be an site area greater than 0.35 hectares, with dimensions of no less than (approximately) 50 metres by 70 metres. Block sites, due to their size, have greater latitude to introduce new densities and characteristics into an urban design zone. Examples are shown at the far right.

Decisions on when to apply 'enhanced' or 'increased' densities with regard to block sites would depend on the block's relative adjacency to other land uses. Blocks within approximately 400 metres of significant public transport connections, significant A1 and A3 land uses, and primary schools would be potential sites for increased densities, depending on significant view corridors or other considerations. For the purposes of the urban design guidelines, a circle with a radius of 300 metres (it is assumed that most paths to the given land use node/transport hub will not involve straight routes) has been drawn - centring on transport hubs, retail centres or schools - to determine this area of potentially increased densities. Family housing should be encouraged as part of any development seeking increased development within the radius of the school.

Alternately, increased densities should be discouraged within approximately 100 metres of green belt land, forming 'the Protected Density Zone'. The determination of minimum block size and the relationship to adjacent land uses has drawn advice from the *Urban Design Compendium*, produced by Llwyn-Davies for English Partnerships and The Housing Corporation in 2000. Designated view corridors would also potentially serve to discourage taller building heights. The view corridors should be reviewed on a case-by-case matter. The guidelines rely on criteria comments and classifications. These classifications are set out below:

Building types

Building types considered for Hemel Hempstead include:

- Terraced housing
- Semi-detached housing
- Detached housing
- Two-storey block of flats
- Three-storey block of flats
- Four-storey block of flats

The Hemel typologies

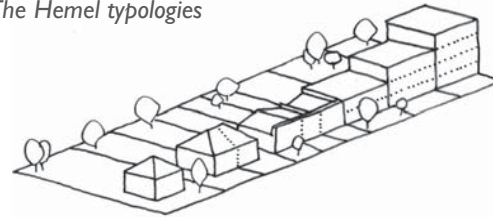

Architectural styles

Architectural styles within the Urban Design zones have been very broadly organised according to the type of roof pitch. The facade applied to terrace buildings generally denotes a more urban character.



Building heights

Building types considered for Tring includes:

- One-storey
- Two-storey
- Three-storey
- Four-storey

Density

The classification for densities is based on Government guidance, reflecting advice in PPG3:

- Very low < 30 dph
- Low 30 - 40 dph
- Medium 40 - 50 dph
- High 50 - 60 dph
- Very high > 60 dph

The diagrams and drawings at the end of this section illustrate the generic typologies, plot sizes and setbacks that have been considered.

Building lines

Building lines will be considered for each Urban Design zone in terms of:

- Large setback (6 - 9 metres, depending on the building height)
- Medium setback (3 - 6 metres)
- Minimal setback (0 - 3 metres)

Building orientation

Building orientation impacts urban design in terms of:

- Building orientation toward street front
- No particular building orientation

Pattern of open spaces

Topography impacts on urban design in terms of:

- Divided front gardens
 - Shared front gardens
 - Divided rear gardens (back-to-back with rear gardens)
- The type of garden reflects on such concerns as the appearance of the streetscape, the privacy of the dwellings, quality of the wildlife habitat, the type of development, and the size of the development site.

Parking

Parking options can be classified as:

- On-street parking
- On-site communal parking
- On-site individual parking

Decisions on the parking type relates to type of streets within the Urban Design zone (primary or secondary through streets, cul-de-sacs, or dead-end streets)

Block samples

The block samples were designed on the basis of the minimum block size of 50x70 metres (0.35 ha). The approximate density per hectare has been calculated by multiplying the number of units in each respective layout by three (or 1.05 has) Because of the constraints of this block, the close block development is much less dense than the perimeter block layout. Given larger blocks, the density of the perimeter block would likely be less. In addition, the size of the setbacks in larger blocks would have a greater impact on the density.

Minimum perimeter block

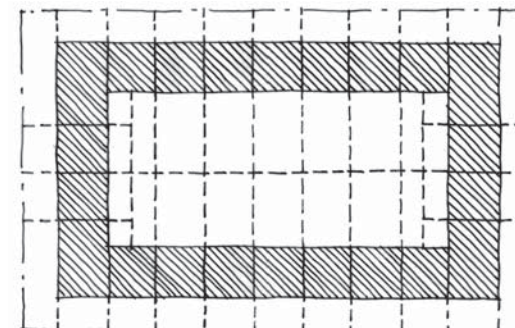

Two-storey terrace blocks (50 x 70m) = 66 dph

3/4-storey terrace blocks (50 x 70m) = 132 dph

Minimum close development block

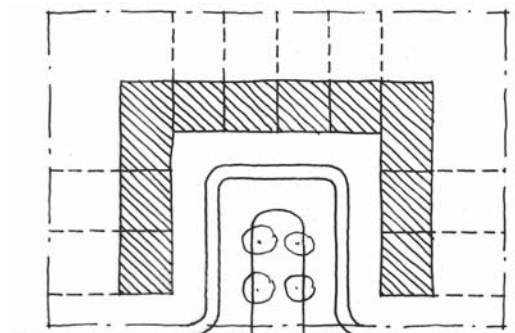

Two-storey terrace close 50 x 70 m = 30 dph

3/4-storey close, 50 x 70 m = 60 dph

Infill samples

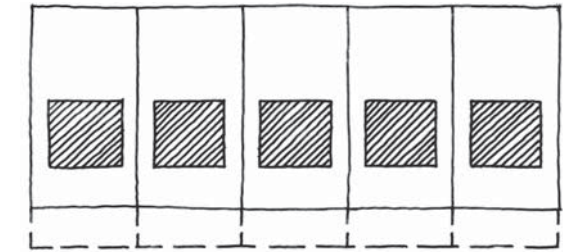

Detached housing, medium setback = 31 dph

(Assumes 5m setback, 11.5m rear garden, 13m x 25m plot)

Detached housing, large setback = 26 dph

(Assumes 10m setback, 11.5m rear garden, 13m x 30m plot)

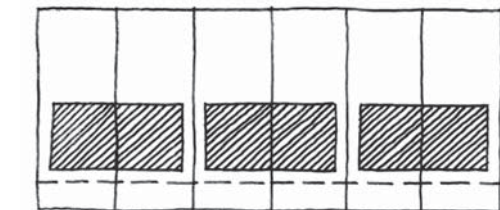

Semi-detached housing, medium setback = 42 dph

(Assumes 3.5m setback, 11.5m rear garden, 9.5m x 25m plot)

Semi-detached housing, no setback = 49 dph

(Assumes no setback, 11.5m rear garden, 9.5m x 21.5m plot)

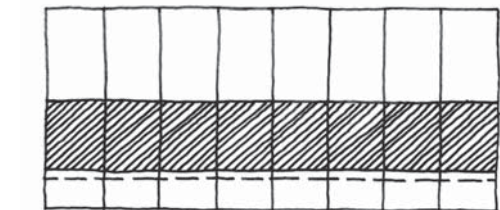

Two-storey terrace housing, medium setback = 57 dph

(Assumes 4m setback, 11.5m rear garden, 7m x 25m plot)

Two-storey terrace housing, no setback = 68 dph

(Assumes no setback, 11.5m rear garden, 7m x 25m plot)

3/4-storey terraces with flats, medium setback = 104 dph

(Assumes 4m setback, 11.5m rear garden, 7m x 25m plot)

HEMEL HEMPSTEAD - TODAY

Physical Location

Hemel Hempstead is situated approximately 25 miles from central London and is the largest town in Dacorum Borough. It sits on the chalk foothills of the Chiltern Hills and lies in a shallow chalkland valley at the confluence of the rivers Gade and Bulbourne. To the north and west lie mixed farm and woodland with scattered villages. Watford lies to the south and St Albans to the east of Hemel Hempstead.

Transport connections

The main railway line from London Euston to the Midlands passes through Hemel Hempstead to the west of the town, alongside the Grand Union Canal. These links, as well as the original A41 trunk road, all follow the natural course of the Bulbourne valley. In the 1990s, a bypass (the A41) was built further west. Hemel is also linked to the M1 motorway to the east, and the M25 is a few miles to the south. The area is well served by buses which provide links to the whole of Hertfordshire and beyond. Coaches also connect the town to the major local airports of Heathrow, Gatwick, Luton and Stansted.

Silverlink trains offer a regular service from Hemel Hempstead to London Euston and Birmingham New Street in the opposite direction. From Hemel Hempstead there are three trains an hour in each direction. The London bound trains take approximately 35 minutes to arrive at Euston. There are connections at Milton Keynes Central and Watford Junction to long distance Virgin services and Southern services to Gatwick Airport and Brighton.

Population and social composition

Census data from 2001 states that the population of Hemel Hempstead is 82,074. There are approximately 33,564 dwellings in Hemel Hempstead and the majority of these households (42%) own at least one car or van, whereas less than 8% own four or more or more motor vehicles. The large majority of residents are White British and the mean age of the population is 37.7. There are 58,206 people aged 16-74. The number of people in retirement is 7,229 and the number of unemployed residents is 1,473.

Planning Policy Context

Hemel Hempstead is designated as a Regional Centre and is also identified as a key centre in which development and change will be focused within the Draft revision to the Regional Spatial Strategy for the East of England.

The Dacorum Borough Local Plan 1991-2011 designates Hemel Hempstead as a town in policy 2. Development will generally be directed towards the town as it is excluded from the Green Belt and is urban in character. Hemel Hempstead will take the largest share of development for housing and employ-

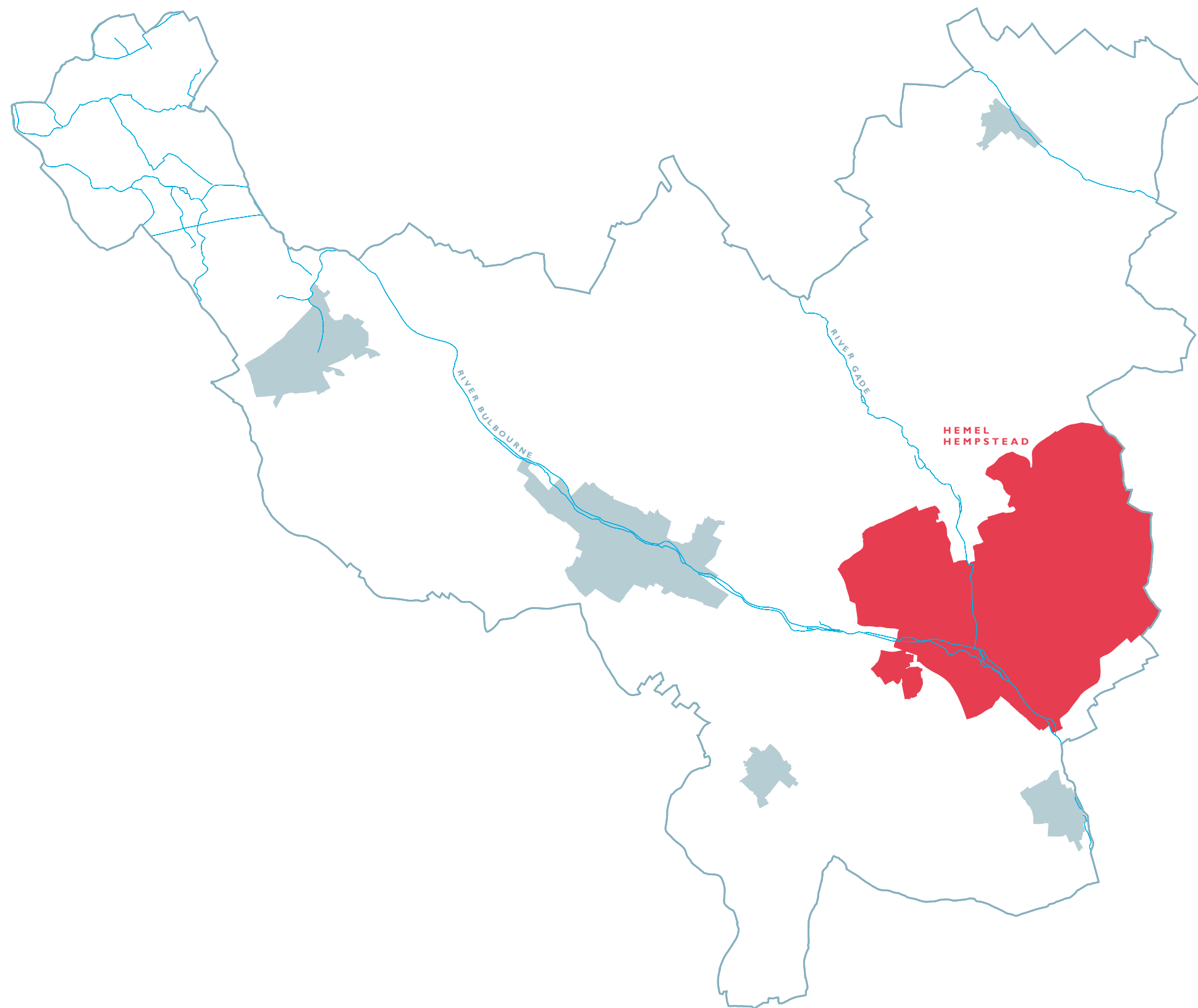

HEMEL HEMPSTEAD - TODAY

ment uses in the borough as it has the widest range of development sites. The town contains the Borough's major shopping, leisure and social facilities and has the best potential for passenger transport usage. Hemel Hempstead contains a designated town centre (policy 39) in the Local Plan. Some areas of the town fall into accessibility zones 1-3 where less parking is required for new, non-residential developments.

Hemel Hempstead has one designated Conservation Area and contains the following ancient monuments and Areas of Archaeological Significance.

Ancient Monuments:

- Highfield Tumulus
- The Charter Tower
- Roman Settlement in Gadebridge Park
- Wood Lane End Roman Site
- Boxmore House Roman Villa

Areas of Archaeological Significance

- High Street
- Queensway
- Wood Lane End

Hemel Hempstead Town Centre Strategy (from the Dacorum Local Plan 1991-2011)

The Hemel Hempstead Town Centre strategy provides the means of achieving a vision of a constantly improving town centre and can also be used to influence land use and transportation planning decisions. The strength of the town centre is in the convenience of its retail offer and attractive shopping environment; however, its role must be broadened. A wider range of shops and diversification into other uses will help to maximise the locational and environmental advantages of the town centre. Encouraging full use of buildings through mixed use and diversification into leisure uses will help Hemel Hempstead sustain its local attractiveness and offer a competitive edge against neighbouring towns. Linkages between the town centre and the surrounding areas would benefit from improved pedestrian routes.

The town centre is defined by a number of zones which form the basis of the town centre strategy.

Zone 1: Old Town Centre

Identified by the high quality of the built environment. The character of the area suggests an opportunity for high quality specialist shops as well as local services for residents within the immediate catchment area. There is potential for the evening economy to be strengthened and for an increased leisure based economy to compete.

Zone 2: Civic, Educational and Professional Housing Dominated by Dacorum Civic Centre and West Herts. College, there is potential to develop services and land uses to serve the working and student population by greater use of urban space to provide a civic focus.

There is scope to purchase student support through bookshops and photocopying as well as professional services such as accountants and solicitors. The area is suited to the development of a lunchtime and evening economy and redevelopment could provide opportunities for a greater emphasis on housing within the zone.

Zone 3: Market Area

The area between Combe Street and Bridge Street contains some service uses. ASDA and Iceland dominate and the market is also located within the zone. It is felt that the market will benefit from being closer to the retail core of the centre as the market faces competition from supermarkets and car boot sales. Relocation of the market would allow development of a modern transport interchange on the current market site.

Zone 4: Marlowes Shopping Area

The Marlowes pedestrian area and the Marlowes Centre are the prime retail areas within the town centre. This is not expected to change, however there is scope for modernisation. The range of shops should be extended and opportunities for catering outlets and leisure uses maximised. The area's excellent pedestrian environment could be extended to other parts of the town centre.

Zone 5: The Plough

Land between the Plough roundabout and Marlowes Shopping Centre has been vacant for approximately 10 years awaiting redevelopment. The site is a gateway to the Town Centre capable of drawing people into the main shopping area. Outline planning permission exists for an office development and a retail warehouse scheme, the retail and commercial elements of which have reached completion.

Land for Development at North East Hemel Hempstead (taken from Supplementary Planning Guidance: Area Based Policies May 2004)

Strategic background:

- The policy statement covers an area of largely undeveloped land on the north-eastern side of Hemel Hempstead and is in response to the Hertfordshire County Structure Plan review which requires the identification of a key employment site on most of this land with the understanding that housing development will also be needed.
- The policy statement notes that key sites have been identified to play a major role in the Hertfordshire economy in Policy 15 of the Structure Plan and reasons that the site is not to be regarded as available for industrial, storage and distributional uses. The involvement of other parties is also stated in this section.

Area covered and cross boundary issues:

- Shows the scope of the policy statement
- States that a priority (for land allocated as a new general employment area) will be given to specialised technological activities and those in the regional and

national interest

- Acknowledges policy 26 of the St Albans City and District Council's Local Plan Review as relevant

The purpose of policy statement:

- Provides an overall framework for development within the plan period
- States more detailed requirements to achieve coordinated, comprehensive development meeting certain country and local needs

Hemel Hempstead High Street

The SPG provides a background to the Conservation Area designation and notes that the Hemel Hempstead Old Town Conservation Area was one of the first to be designated in the county in 1968 and is based on the High Street. The character appraisal of the area takes several aspects into account:

- The historical landscape and townscape
- Important characteristics and architectural elements of the area, which include
- A harmonious coexistence of rural and urban features
- A mixture of building styles, dates and materials
- Fine brick or brick and flint walls
- Old covered cart entrances or through alleyways
- The painted, stuccoed buildings in various pastel shades
- The retention of blue street signs

The Conservation Area boundary is said to encompass the character and special value of the Old High Street and the Townscape analysis identifies several important streets and spaces, such as the High Street, the market place, Gadebridge Park and Queensway.

Characteristic features of building design, dominant styles, periods of development (with consideration of massing and scale) are also documented. The relationship between the existing structures and open space notes that:

- The relationship between urban and rural settings has been retained
- The market is the dramatic opening up of a densely built street
- There exists a small pedestrian area around Austin's Place which links to surrounding housing developments

In terms of form and structure, the commercial heartland of the town is said to run from north to south along the gradient of the hill and alleyways, linking the High Street to development behind. A brief assessment is made of existing street furniture and is thought to be generally well maintained, although there is an expressed view to ensure that the special nature of the area is retained through an enhancement scheme. In addition the market place, Queensway and the entrance to Gadebridge from Queensway are said to be areas in

need of attention.

designated on the proposals map). The layout of built elements of a scheme should avoid disruption of any wildlife linkages and planting should create continuity of species.

Landscape Characteristics of Areas Surrounding Hemel Hempstead (taken from Supplementary Planning Guidance: Landscape Character Assessment for Dacorum May 2004)

Surrounded by 11 different landscape areas: High Gade Valley, Gaddesden row, Revel End Plateau, Upper Ver Valley, Buncefield Plateau, St. Stephen's Plateau, Bedmond Plateau, Upper Gade Valley, Bovingdon and Chilperfield Plateau, Lower Bulbourne Valley, Little Health Uplands.

- Land cover and land use
Predominantly open farmland with secondary areas of pasture and woodland.
- Transport patterns
Area has several arterial routes traversing the area. The London to Glasgow railway, Grand Union canal and to the south the M1, M25, M10, A41 and A4146. There is also a network of secondary and minor roads and lanes in the area.
- Key characteristics of area:
Open arable farmland and pasture with isolated settlements as well as urban fringe influence.

A Draft Regeneration Strategy for Hemel Hempstead May 2005

A Regeneration Strategy for Hemel Hempstead was produced and adopted by Dacorum Borough Council in 2005, (to be officially be launched in early 2006). This document sets the Council's vision for Hemel Hempstead town centre, creating a framework for direction for council activities business investment and partners. The aim of the vision is primarily to identify and stimulate private sector development (residential and other) to be delivered through key partnerships. The strategy is yet to be consulted on and therefore does not incorporate the views of the public partners, Local Strategic Partnership, business, land owners and other stakeholders.

The aims of the draft vision are:

- To meet local development needs, particularly housing and affordable housing, creating neighbourhood and civic pride and protecting valued open spaces
- To create a more exciting thriving, safe and clean town centre
- Rejuvenation of Maylands to achieve a vibrant, dynamic and premier business led community and first choice investment location
- Rejuvenated local Neighbourhood centres, both in

HEMEL HEMPSTEAD - TODAY

terms of services and facilities and building design/appearance

- Up-to-date strategy to address traffic problems, including enhanced links between railway stations
- Promotion of key facilities such as hospital and college
- Regeneration through conservation and enhancement of built environment of the old town
- Improve sports and visitor facilities at Bunkers Park
- Improve network of open spaces with linkages to create attractive travel options
- Support for partner regeneration projects

Draft Vision for Town Centre

Comprehensive approach to securing development opportunities where all components demonstrate a planned approach and contribute to town centre regeneration to achieve the following:

- High quality development
- Maximise potential
- Achieve dual use of, for example, public open space and car parking
- Co-coordinated facilities to support the Town Centre as a whole
- A strong, clear urban design framework/ scheme to achieve essential components within an enhanced and inspiring townscape setting.
- At least 600 new dwellings in or on the edge of the town centre including appropriate levels of affordable and key worker housing
- Mix of uses in the Town Centre
- Mixed use development schemes to be promoted
- Relocation of the market into an improved pedestrian area in the Marlowes
- Creation of new development opportunities fronting an improved Water Gardens
- Versatile performance and conference venue with associated uses
- Enhancement of the natural chalk stream corridor as a feature and wildlife corridor
- A comprehensive Town Centre Enhancement Scheme to be secured as part of and being integral to the re-development proposals
- Consider the creation of a town square and improved pedestrian links to Hemel Old Town
- A fresh look at Town Centre movements and replanned to secure development opportunities and enhanced pedestrian movements
- Review of bus links and town centre facilities to enhance passenger transport and transport interchange
- Replacement public service facilities and offices as part of new concept for public service delivery

The vision must be delivered in a coordinated way using the Council's powers, land assets, influence and limited resources. Additional resources come from the private sector; key organisations such as English

Partnerships, bids for available grants and resources from the Region, Government and Europe.

The vision is ambitious and only achievable over a long timeframe, possibly 10-20 years; however, there are clear priorities and deliverables in the more medium and shorter terms. Suggested short term deliverables are:

- A new performance and conference venue
- New council offices
- Significant development, both residential and commercial to deliver the above
- Town Centre enhancement and a plan to integrate the Water Gardens with the town centre.

Hemel Gateway Options Report Final Report January 2005

Produced by Roger Tym and Partners Planners and Development Economists, this report forms part of the wider SW Herts Employment Space study and assesses the long term potential of the Hemel Gateway site. It indicates, in broad terms, the future development possibilities of the area and considers questions which may need to be addressed with regard to the LDF.

It puts forward a series of issues and questions, such as;

- Creation of a gateway and key "entry point" from Hemel Hempstead from the M1
- The possibility of identifying sites for a Park and Ride facility
- The appropriateness of current land use designation for specific site and feasibility of their re-designation
- The potential for development of open land

The report provides a site description which identifies major site characteristics such as dominant or significant transportation corridors and the lines of movement and access of specific roads/routes. The relationship between vehicular traffic and pedestrian traffic, along with areas of ecological/environmental importance and natural boundaries are also referred to briefly.

Both a graphic and written SWOT analysis is provided and ascertains that there are weaknesses with regard to road capacity, congestion and accident black spots and a threat towards site and development access from major roads in the area. In terms of opportunities, the report highlights the potential to improve landscape screening to the existing residential area and attract major investment to the area by creating a 'new image' through good building design and quality. The strengths of the site were distilled to the site's proximity to junction 8 of the M1, prominent development opportunity sites, the attractive character of Buncefield Lane and the current existence of some 'Gateway' development already being in place.

The report then goes on to consider the Gateway site as a potential development opportunity, its suitability for this function and the characteristics that a Gateway development would take. The context for development of the Hemel Gateway site in view of the implications of the SW Herts Employment Space Study and applicable planning policy for Hertfordshire is also noted. The report also considers the possibility of using the site for the development of a science park along with other alternatives, such as broader office-based development and concludes that either of the options is feasible but that there is no justification for the development of both. The report concludes with a number of additional points:

- Owing to its size, and prime location, the site has the ability to be a 'high quality/impact' employment site but currently does not make a positive statement about Hemel as an employment location.
- There are several constraints to development of the southern portion of the site, below Breakspare Way. The developable area here is insufficient and is not considered to make any real contribution to the Gateway development. Meaningful employment development is possible to the north and this would be the focus of development.
- Highway issues are of concern and there is a need for more information and guidance from the Highways Authority with regard to network capacity, implications of development to the M1 and access options for the Gateway site.
- The possible costs of highways works are likely to be incurred through redeveloping the Gateway site need to be considered.
- The likelihood for the success of a Science park in absence of other 'driving' higher education institutions in the area is an area of concern and requires more thought.

Hemel Hempstead Civic Zone Development Brief Supplementary Planning Document. November 2005.

The SPD has been prepared to inform and guide prospective developers on the potential opportunity to comprehensively expand and redevelop Hemel Hempstead's civic core and to re-anchor the town centre. The development brief has been designed to supplement the town centre strategy, outlined previously, providing a greater level of detail. The development brief area falls within two of the Town Centre Strategy Zones; Zone 2 – Civic, educational and professional housing and Zone 3 – Market Area and totals approximately 5.8 ha. The area provides a unique opportunity to create a high quality, civic led, mixed use development to help strengthen Hemel Hempstead's town centre.

The Council's vision is to create an enhanced part of the town centre which

- Accommodates a mixed use development including civic, residential and retail uses in order to strengthen the overall vitality and viability of Hemel Hempstead Town Centre
- Creates a more cohesive development which acts as a transition to improve the linkages and footfall between the prime shopping area and the rest of the Town Centre.
- Provides a high quality mix of uses to the highest design quality accentuated by feature buildings at a key gateway to the town centre;
- Respects the character and setting of the area surrounding the site;
- Enhances the street scene by facilitating pedestrians, traffic calming or other measure to reduce the impact of vehicles where this can be complemented by sustainable alternative measures to maintain/improve accessibility;
- Incorporates sufficient and appropriate access, servicing and car parking;
- Brings forward significant residential development including an appropriate level of affordable and key worker housing (residential development to be part of mixed use schemes where appropriate);
- Accommodates retail uses to meet retail projected needs;
- Improves east to west and north to south pedestrian movements through improved links to the Marlowes; Gadebridge Park, Water Gardens and Hemel Hempstead Old Town;
- Take opportunities to address wider traffic circulation to improve Town Centre functioning;
- Give improved priority to pedestrians, cyclists and passenger transport; improve highway urban design and enhance traffic flows;
- Reinstate the Chalkstream and enhance its biodiversity and amenity value;
- Create a new civic focus with a possible new Performance and Conference Centre which links with and supports commercial activities;
- Achieve the highest quality development with a clear and effective urban design;
- Create a more cohesive development which acts as a transition to improve the linkages and pedestrian movements;
- Enhances the street scene by facilitating pedestrianisation, traffic calming or other measures to maintain/improve accessibility;
- Incorporates sufficient and appropriate access, servicing and car parking
- Enhances and maximises well designed, high quality public open/ green space;
- Contributes to the long term management and maintenance of the town centre as a whole; and
- Makes the most efficient use of land, buildings, energy, water and waste.

HEMEL HEMPSTEAD - HISTORY

In common with other parts of the Gade Valley, the Hemel Hempstead area was extensively settled during the prehistoric period, with habitation from the Bronze Age onwards (c 4,500 - 2,800 years ago). There is also evidence of Roman occupation, particularly to the west and south-west of the old town, around Boxmoor. At Gadebridge Park the remains of a large Roman villa were unearthed in 1963.

The present town probably began during the Saxon period (6th-11th centuries) as a small village, situated about a mile and a half north of the point where the Gade and Bulbourne rivers converge. The name of the town is derived from 'Haemele's homestead', Haemele possibly being the name of a tribe or individual.

The history of the medieval manor is unclear, but at least half of it is known to have been granted to the monastic college of the Bon Hommes of Ashridge, lasting up to the dissolution of the monasteries in 1539. Hemel Hempstead's fine Norman church, St Mary's, was started around 1140 and is one of the oldest surviving churches in Hertfordshire. The inhabitants of the medieval village would have worked the land for the benefit of the monks of Bon Hommes but there was also a market, located to the east of the church. Unlike its neighbours Kings Langley and Berkhamsted, Hemel did not enjoy royal patronage and its market remained small until the 16th century, when a charter was granted and fortunes increased. By the mid-17th century Hemel Hempstead had become one of the most prosperous towns in the area, noted by Daniel Defoe in 1726 for the number of corn mills and the size of the market.

Like Tring, Hemel developed an important straw plaiting industry and the yards behind the east side of the High Street were used for the sale of wheat and barley. There were also butchers stalls (shambles) and cattle markets. On the west side of the town stood Gadebridge Park, a substantial Georgian mansion that was demolished in 1973 to make way for the Kodak Training Centre.

In the 18th century a turnpike road at Sparrows Herne, to the south of the town, was the main route to London and northwards through the Chilterns. The Grand Junction Canal (1804) followed the course of the turnpike and enabled cheap, long distance haulage of coal from Birmingham as well as an array of building materials, including slate, stone and brick. The London-Birmingham railway was diverted from the town by local landowners and the station was built at Boxmoor. Later, a branch line was built by the Hemel Hempstead Railway Company which in turn led to the development of the Alexandra Road area.

A local paper manufacturer, John Dickinson, established

a business in 1807 at Apsley Mill in the Bulbourne valley, making the first mass produced paper. Dickinson's enterprise grew over the following decades to become Hemel Hempstead's biggest employer with around 1000 employees by 1896. Apsley Mill was converted to a munitions factory in the Second World War and was eventually demolished in 1992. It is now the site of Sainsburys supermarket.

By the middle of the 20th century Hemel Hempstead was practically three separate areas; the old town to the north, the Boxmoor commuter suburb around the railway station, and the industrial development in the valley. In 1946 Hemel Hempstead was one of eight towns around London chosen to take new development for London.

[Significant information courtesy of Hertfordshire County Council Archaeology Section in conjunction with English Heritage.]

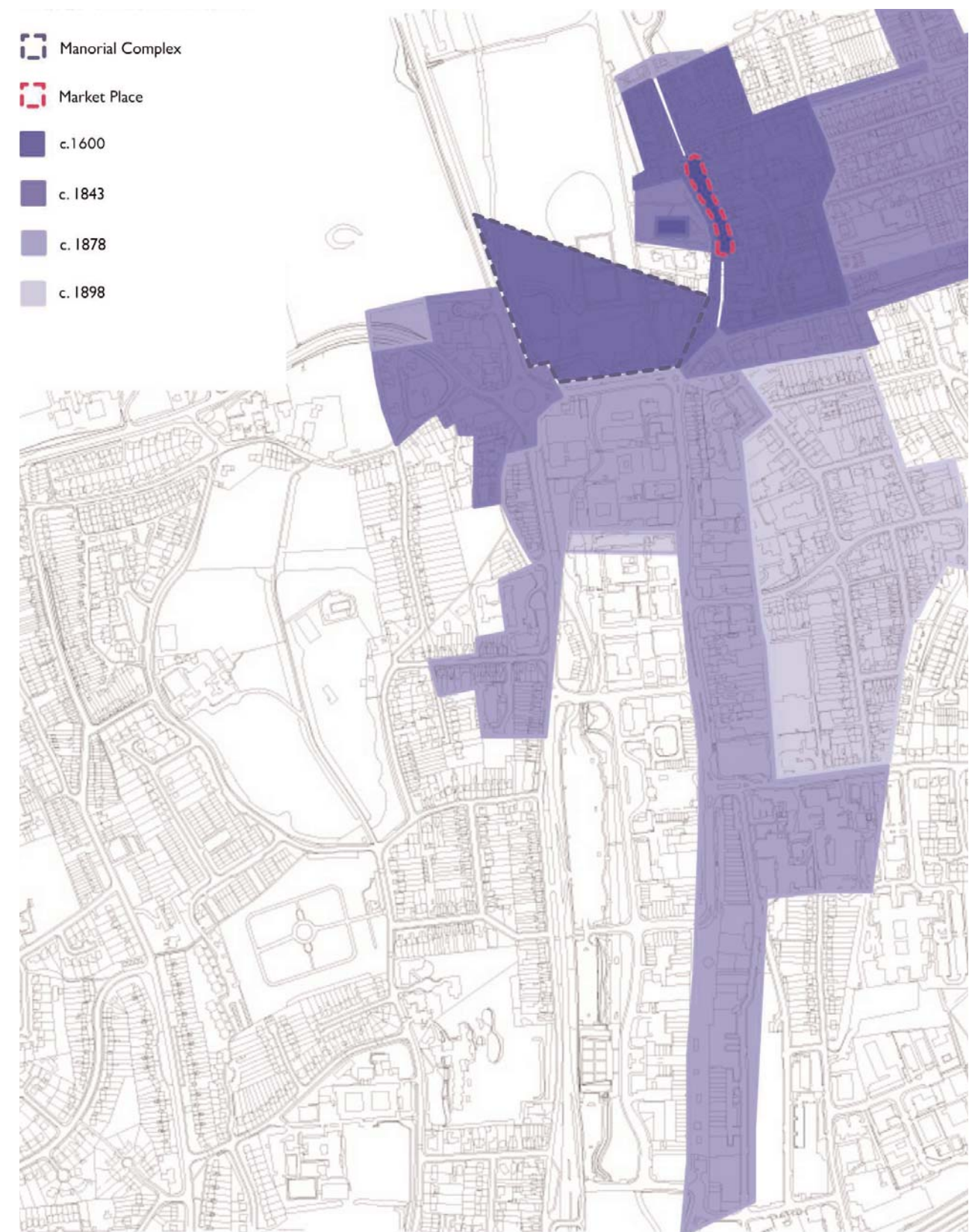

Reproduced from the Ordnance Survey mapping with the permission of the Controller of Her Majesty's Stationery Office © Crown copyright. Unauthorised reproduction infringes Crown copyright and may lead to prosecution or civil proceedings. Dacorum Borough Council License No. LA1000 18935 2006

HEMEL HEMPSTEAD NEW TOWN

Hemel Hempstead was selected as one of the Mark One New Towns which were to begin development between 1946 and 1950. Hemel Hempstead had the largest existing population (21,000) prior to the New Town expansion of any of the Mark One towns, creating an additional challenge to integrate the old and new settlements.

The New Towns Project aimed to meet a series of goals to create self-sustainable communities that



offered affordable residential communities with local employment areas. The urban design and planning challenge to create new cities outside of existing urban centres had a significant history by the time the New Towns were developed. Two contrasting examples presented at the turn of the century were Ebenezer Howard's Garden City model and Arturo Soria's Linear City. The Garden City sought to draw the best from both the countryside and the city to create a radial city of a limited population of 32,000 people. Given its small size, the surrounding countryside would be easily accessible. In contrast, Soria's proposed Linear City suggested populations of up to one million which would occur along linear mass transport systems. These linear cities would run parallel to easily accessible countryside. From an urban design perspective, New Towns have followed in tradition of the Garden City, creating discrete new settlements.

Hemel Hempstead Town Centre

Hemel Hempstead New Town Centre is currently a one-mile linear centre which combines educational, civic, commercial and retail buildings. The New Town Centre was separated from the Historic Old Town as a means of protecting the historic urban fabric while facilitating a new town centre with modern transport means, shops, and amenities. Today the old town High Street is an enclave with several listed buildings from all periods. Many of the original plans for the new Town Centre did not come to fruition but are worth reviewing.



Photo above courtesy of Hertfordshire County Records



Hemel Hempstead Neighbourhoods Concept

The development of the New Towns polarised many planners and architects when considerations were first being made in the 1930s. While each group could accept that Ebenezer Howard's vision of self-sustainable towns would relieve London's population growth, the question of how this town - and in particular the residential areas - would look raised a significant debate. On the one hand, many planners enthusiastically looked to replicate the curvilinear streets and well-groomed residential areas of Welwyn Garden City and Letchworth. On the other hand, modernist architects reacted against this individualistic approach to development and advocated high density flats, mass transport options and community facilities.

J M Richards summarised these arguments as 'often confused because the former quite unjustifiably identified the idea of a garden city with low-density (Ebenezer Howard never demanded houses at only

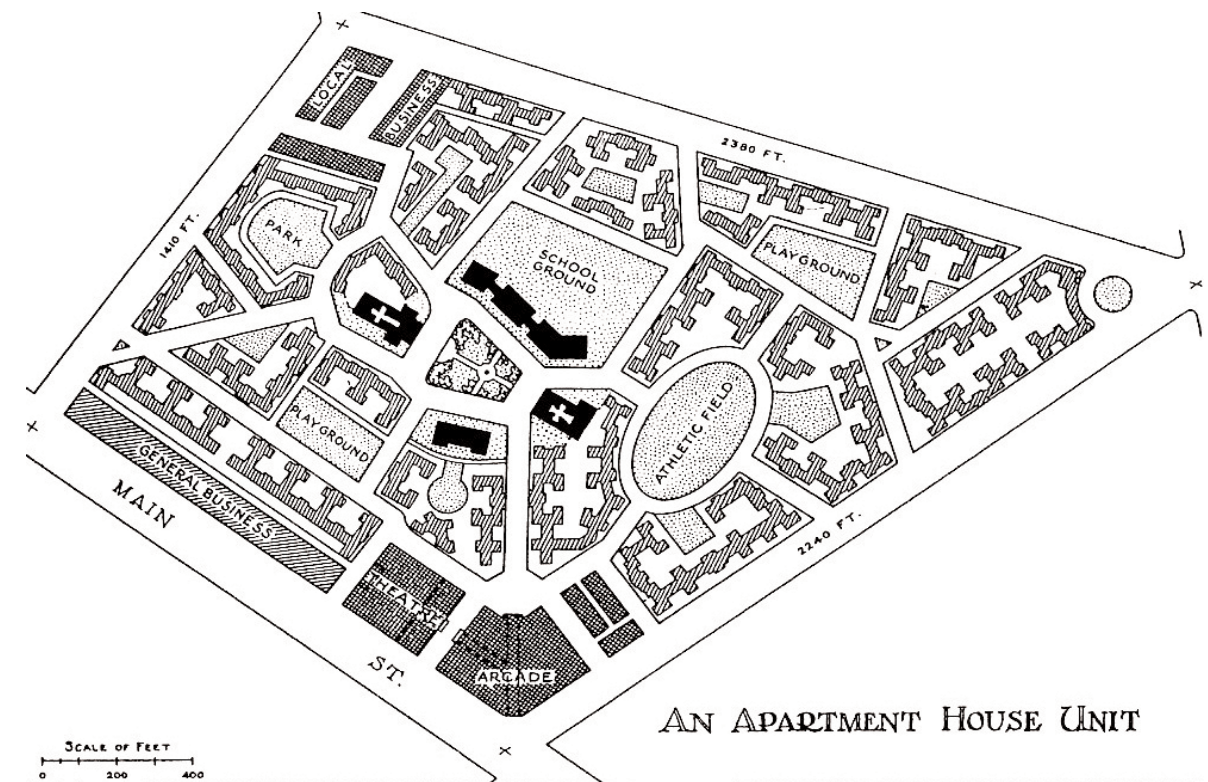

Clarence Perry's 1926 design of the neighbourhood unit.

twelve per acre) and the latter allowed themselves to be sidetracked into a different and quite unreal battle of cottages versus flats, thereby making the garden city fanatics a present of the allegiance of that majority of Englishmen who are wedded to the idea of the one-family house with its bit of garden'. (from *Architectural Review*, July 1953).

The compromise in this debate came from abroad. The 'neighbourhood unit', initially developed in 1912 as part of a Chicago architectural competition (the jury members included Raymond Unwin) and developed by American planner Clarence Perry in the 1920s, put forward the concept of a self-contained neighbourhood. Each unit, according to Perry, would have a school and community centre with open space at its centre and its own shops along the unit's periphery. Arterial streets would be kept at the unit's edge to facilitate pedestrian safety, and the unit size would be based on the population needed to fill a primary school and distances of a half-mile walk or less to the school.

The neighbourhood unit concept, while developed in the United States, was heavily influenced by British planning and social welfare thinking, from Raymond Unwin to Toynbee Hall. The neighbourhood unit

concept first entered UK planning dialogue in the 1930s, bridging the divide that had emerged between planners and modernist architects. Both parties could agree on the basic assumptions of the neighbourhood unit, including the segregation of circulation system into arterial roads and residential streets and separation of land uses and functions that provided areas for employment, residential, and major retail uses. While the Garden City planners were enthusiastic about the segregated residential neighbourhoods, the modernist thinkers saw the potential for neighbourhood units to incorporate community facilities and enable the breakdown of class divides.

Hemel Hempstead's New Town Neighbourhoods did not appear exactly as drawn by Clarence Perry, but many of the basic principles have survived. Rather than having shops along the arterial roads at the periphery of the Hemel neighbourhood units had 'local centres' with shops in the middle of each neighbourhood. Most Hemel neighbourhoods have schools in them, but they do not play the 'centring' role originally envisioned by Clarence Perry.

STRATEGY PLAN and SETTLEMENT PRINCIPLES

Urban Design zones

- A The Town Centre zone (1) should continue to serve civic, cultural and educational purposes. There is considerable potential to add additional residential uses to the zone.
- B The Inner zone (2) is primarily Victorian housing that should provide quality high to very high density housing with strong links to the Hemel town centre, train station or the growing centre at Apsley.
- C The New Town Neighbourhoods zone (3) contain a range of typologies with a range of densities, from low to very high integrated with local centres, open land and schools. This zone should provide quality low-rise, generally medium to very high density housing which accentuates the existing street morphology and topography.
- D The Post-New Town Residential and Peripheral Zone (4) contains primarily detached housing with very low to low densities. This zone does not should provide low to medium density housing.
- E The Employment zone (5) generally has building with large, industrial footprints. Much of the Apsley area is being converted to a range of uses, and this part of the zone represents an opportunity for integrated uses with a high to very high residential density adjacent to a train station.
- F Potential increased density zones: A number of increased density zones have been determined due to proximity to shops, transport or schools.

Circulation

- G The primary distributors should facilitate through traffic, ensuring that two-way traffic is prioritised over on-street parking.
- H District distributor roads should facilitate through traffic, ensuring that two-way traffic is prioritised over on-street parking, with street design to ensure calmed traffic, and efforts made to include cycling routes.
- I The High Street (local distributor) within the town centre should be considered as an activity zone which prioritises High Street uses, such as pedestrian crossings, over through traffic. Through traffic should be discouraged and vehicular traffic on the Marlowes should continue to be prohibited.
- J Access roads (residential streets) should encourage on-street parking unless the street width is a constraint.
- K Footpaths should be considered as significant pedestrian routes which receive design attention.

Views

- L There are several prominent views with Hemel Hempstead based on the valley topography, the areas of open land within Hemel, the presence of significant orientation points and the views along the Canal. These views should be

- 1 Town Centre
- 2 Inner Zone
- 3 New Town Neighbourhoods
- 4 Post-New Town and Peripheral Residential
- 5 Employment Zone
- Designated open land
- Primary vehicular route
- District Distributor
- High Street within towncentre
- Key footpath
- Proposed gateways
- Proposed view corridors to be protected
- Potential increased density zone
- Protected density zone

protected, and the massing, height and architectural impact of any new development within the view corridor should be considered in a design review.

Legibility

- M St Mary's Church and the Kodak building form critical orientation points for the town centre, from the train station and the movement through the town.

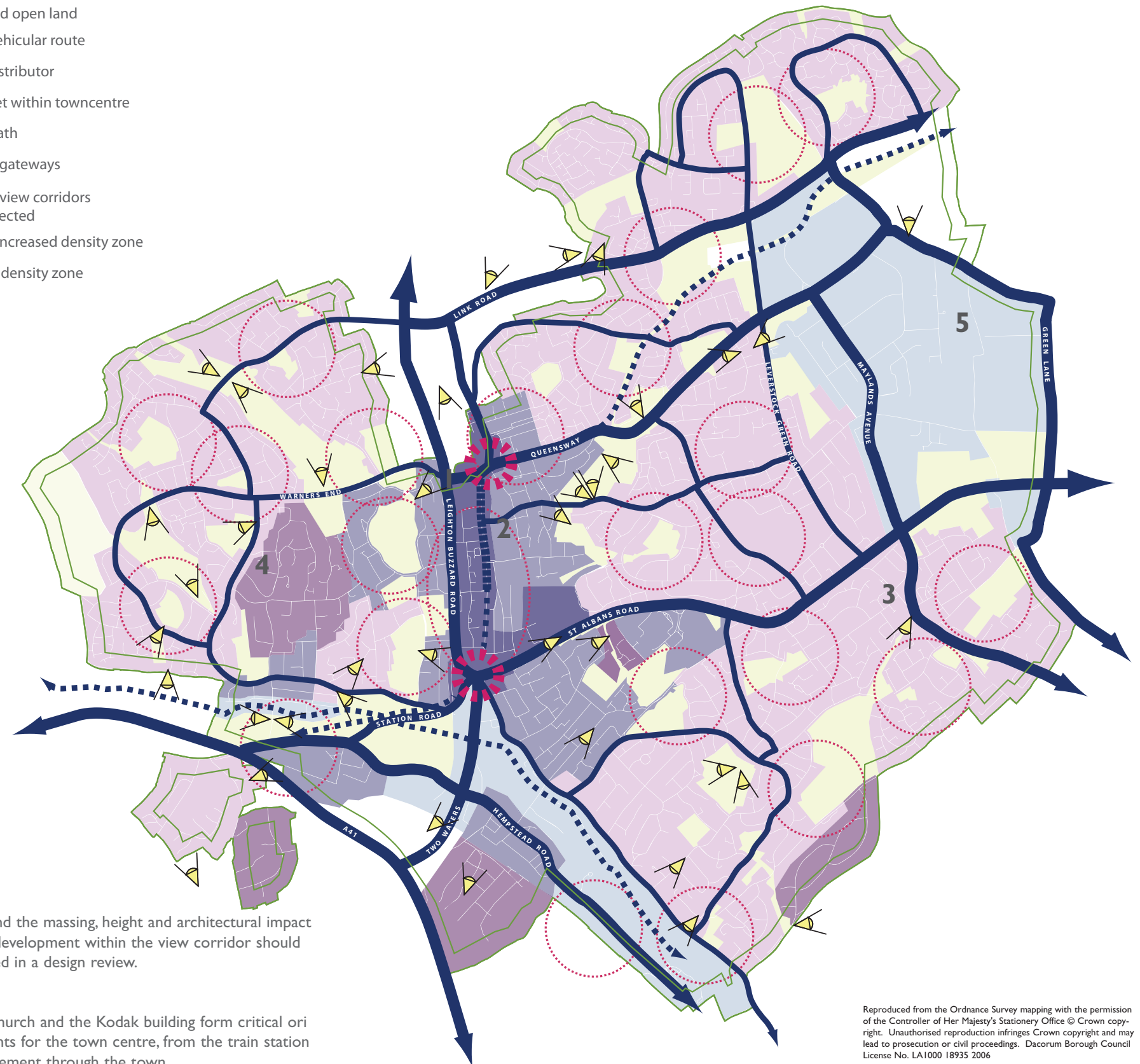

STRATEGY PLAN and SETTLEMENT PRINCIPLES

- 1 Town Centre
- 2 Inner Zone
- 3 New Town Neighbourhoods
- 4 Post-New Town and Peripheral Residential
- 5 Employment Zone
- Designated open land
- Primary vehicular route
- District Distributor
- High Street within towncentre
- Key footpath
- Proposed gateways
- Proposed view corridors to be protected
- Potential increased density zone
- Protected density zone

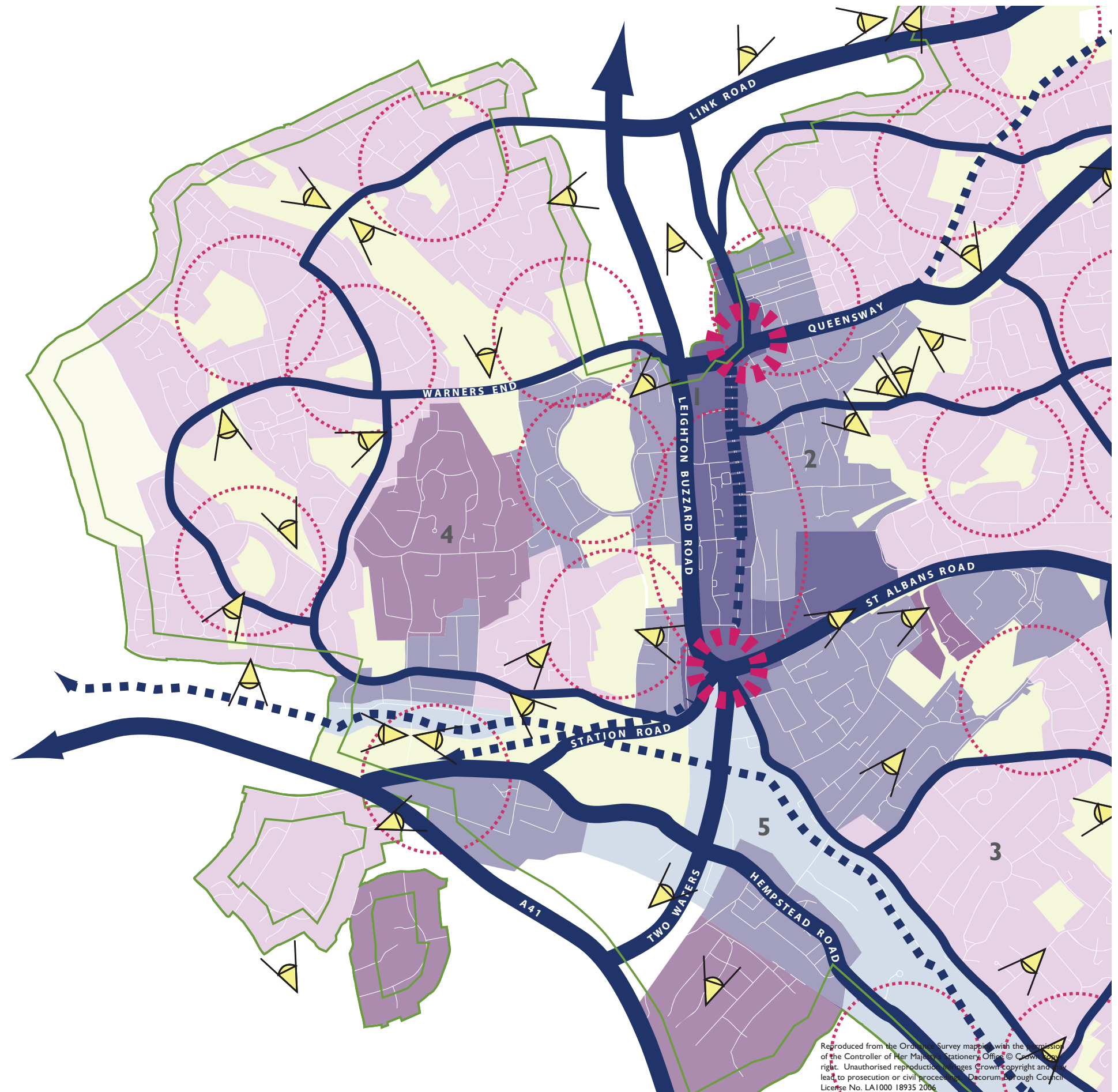

Reproduced from the Ordnance Survey mapping with the permission of the Controller of Her Majesty's Stationery Office © Crown Copyright. All rights reserved. Unauthorised reproduction infringes Crown copyright and may lead to prosecution or civil proceedings. DACORUM Borough Council License No. LA1000 18935 2006

STRATEGY PLAN and SETTLEMENT PRINCIPLES

- 1 Town Centre
- 2 Inner Zone
- 3 New Town Neighbourhoods
- 4 Post-New Town and Peripheral Residential
- 5 Employment Zone
- Designated open land
- Primary vehicular route
- District Distributor
- High Street within towncentre
- Key footpath
- Proposed gateways
- ▲ Proposed view corridors to be protected
- Potential increased density zone
- Protected density zone

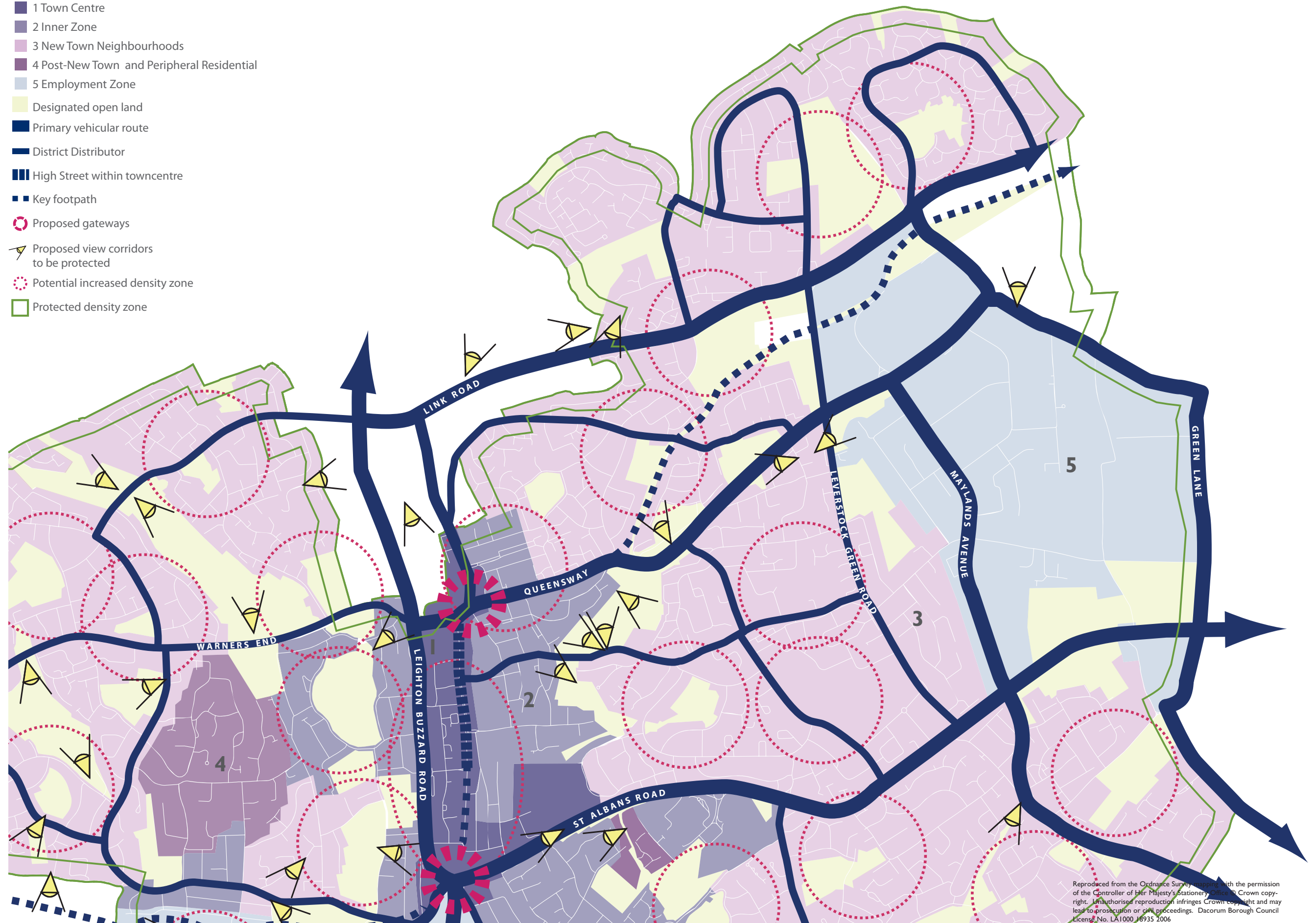

STRATEGY PLAN and SETTLEMENT PRINCIPLES

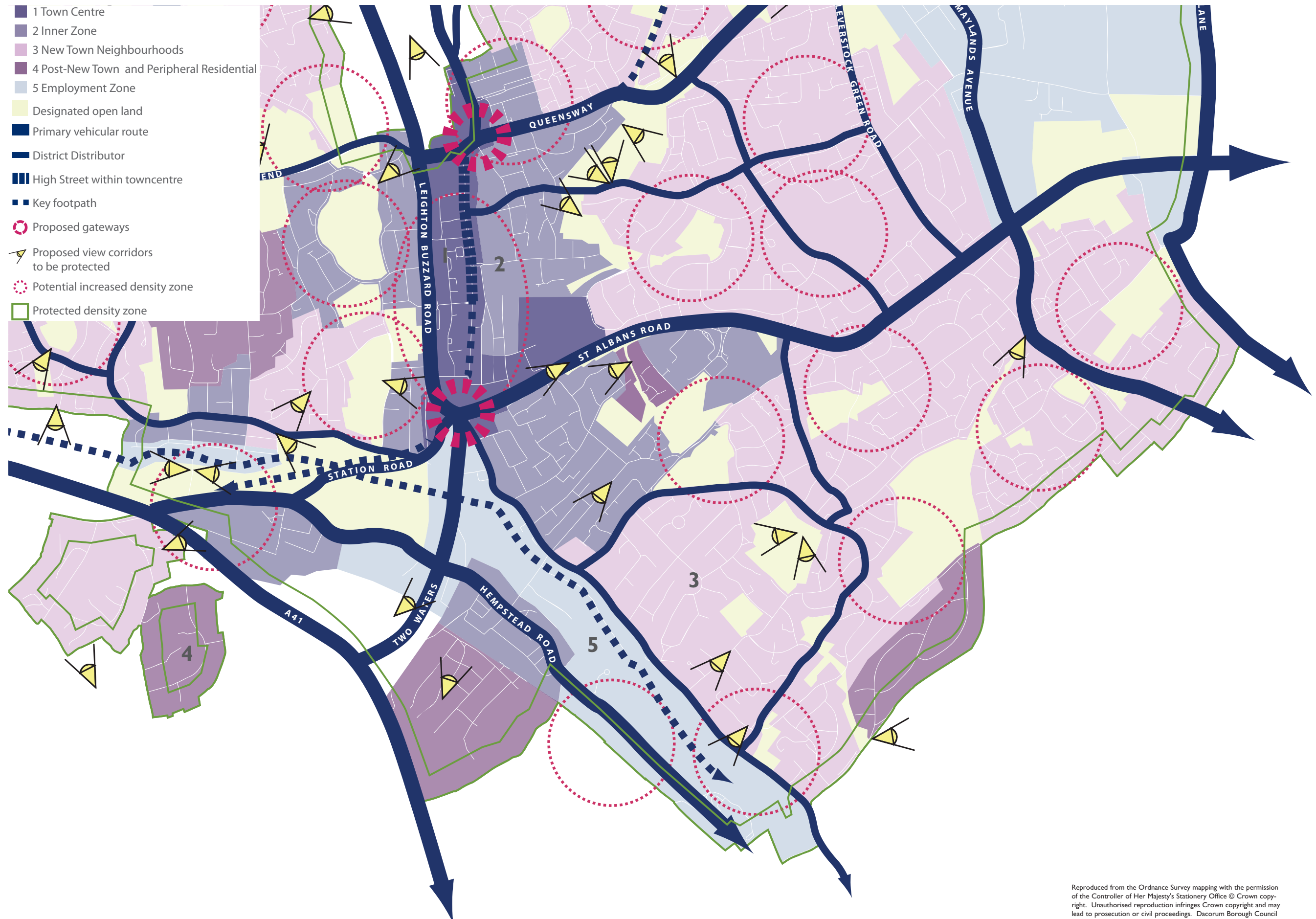

URBAN DESIGN ZONES

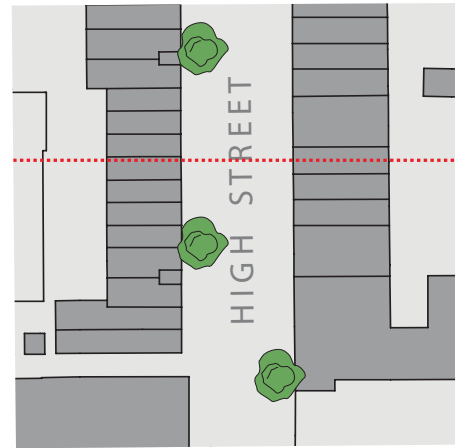

Town centre zone

The town centre extends from the northern part of the settlement and Gade Park south to the 'magic roundabout' east of the Leighton Buzzard Road and includes the Marlowes and Wolsey Road. There are four major areas within it: the Old Town Centre; the civic, educational and professional housing area; the market area; and the Marlowes Shopping Area. The area should continue to be a civic and cultural centre with the potential to provide very high density housing.



Inner zone

Hemel Hempstead experienced a surge of growth throughout the 19th century due to Old Town Centre's markets and the activities along the Grand Junction Canal and the railway. As a result, a number of areas were developed in Victorian times and in the following interwar period throughout Hemel Hempstead. The street patterns were generally dense gridded streets. The inner zone should continue to be a high to very density residential area with low-rise terraced housing and minimal set-backs.



New Town Neighbourhood Zone

The New Town neighbourhood development began in the late 1940s with many areas not seeing completion until the 1960s. These areas were planned in a cohesive fashion, generally bordered by distributor roads and consisting of curvilinear streets with local shopping centres, and a school with open land. They were planned with a mixture of typologies and densities ranging from low to very high with two-storey detached houses and three-storey terrace buildings with flats.

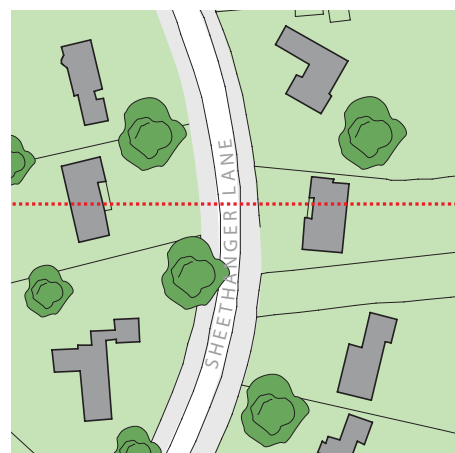

Post-New Town Residential and Peripheral Zone

This zone incorporates post-New Town developments which occurred primarily as low-density residential areas at the periphery of Hemel Hempstead or large infilled areas near the New Town neighbourhoods. With the exception of the 1990s estate not far from the Town Centre, these areas have curvilinear or cul-de-sac streets with detached housing and no local centres. This area could potentially become denser with smaller plots and the introduction of semi-detached houses.



- 1 Town Centre
- 2 Inner Zone
- 3 New Town Neighbourhoods
- 4 Post-New Town and Peripheral Residential
- 5 Employment Zone

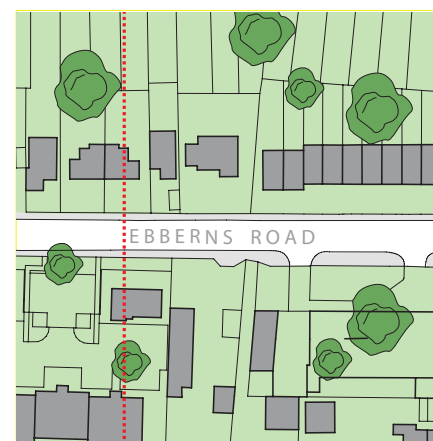
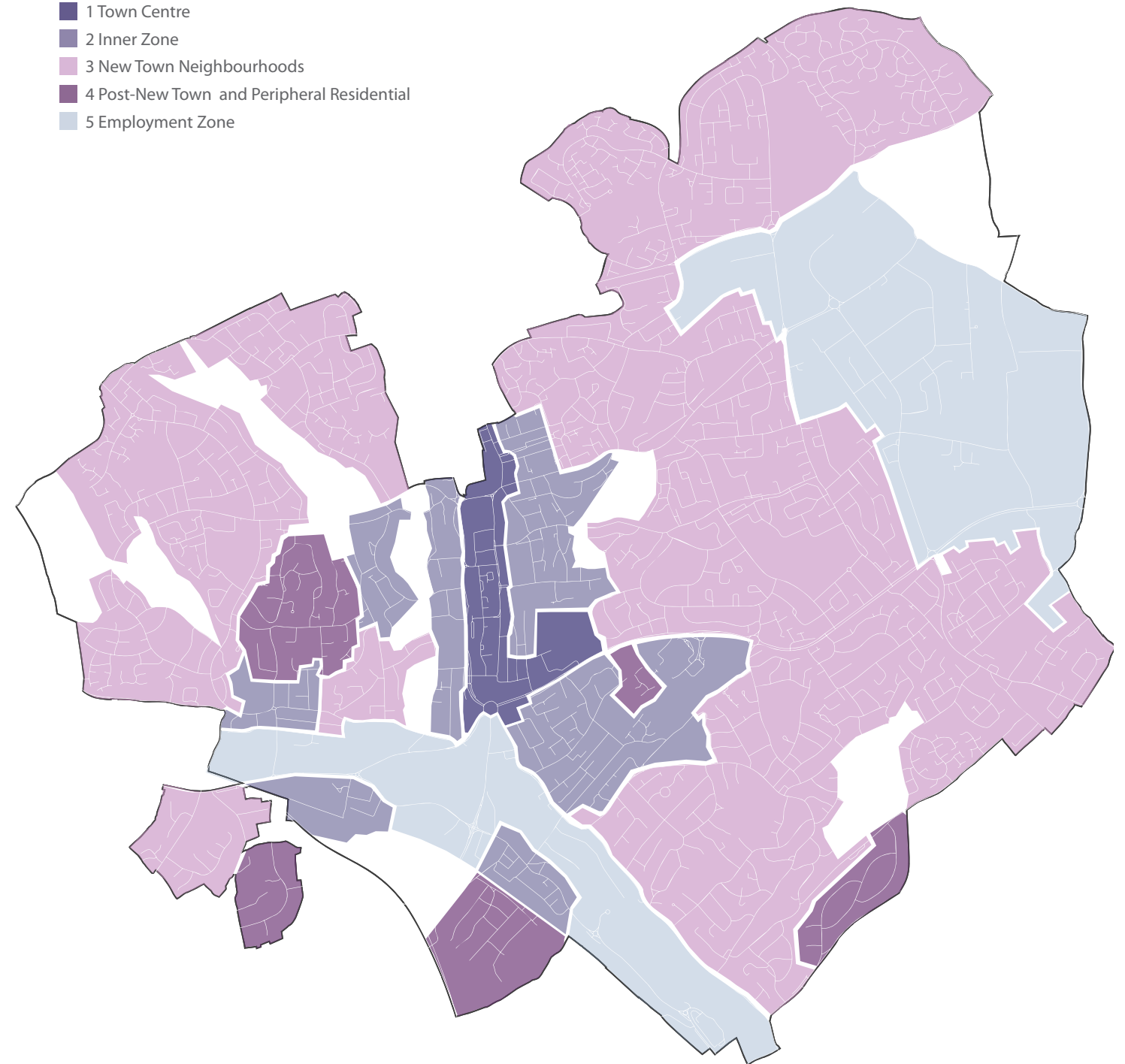

Employment Zone

The employment area located at the north-east edge of the settlement and the southern zone along the Grand Union Canal. Apsley has a number of areas being converted to housing, and this part of the zone represents an opportunity for integrated uses with a high to very high residential density adjacent to a train station.



URBAN DESIGN GUIDELINES: TOWN CENTRE ZONE

	Criteria	Guidelines	Page Reference	Photo Reference
Making places	Building types	The town centre has a tremendous range of building types, including the listed buildings of the Old Town and the modernist buildings of the Marlowes. Building heights range tremendously from the Kodak building to two-storey buildings. Building types should be considered within the zones four areas (Old Town, Civic/Educational area, Market area, the Marlowes) as well as the emerging residential area at the southeastern end of the town centre. There is the potential for relatively high-rise mixed use area in the current civic, educational and market areas. The Old Town should retain its low-rise terrace character.		
	Materials / architectural styles	The town centre has a range of building types, depending on the area. While the Old Town is made up of traditional materials and styles, the other areas feature modern materials and approaches. High quality modern building should be encouraged.	30-32	42-43
	Listed buildings/ Conservation Area	There are several listed buildings within the Old Town and in the Civic and Educational area. While the Conservation Area has protected the context of the Old Town's listed buildings, some within the Civic and Educational area suffer from the surrounding context and their adapted uses. Efforts should be made to protect these buildings. There also may be elements of the original New Town Centre along the Marlowes which are worthy of listing.	33-35	
	Building Heights	Building heights should be determined by areas within the zone. The Old Town Centre should remain predominantly three-storey. The Marlowes would benefit from remaining generally at a human-scale, with heights from three to four storeys. The other areas could consider building heights greater than four storeys, particularly on the western side of the street.	36	
	Density	The areas with residential uses generally have high densities. It is assumed that new developments could have high to very high densities and be of mixed uses. The market area and civic and educational area would have potential for mixed use residential development.	37-38	44-46
	Topography	The town centre lies in the river valley, forming a focal point for views from the valley sides. The Kodak building and St Mary's Church are important orientation points. There are also important views along the Water Gardens and the Old Town High Street.	39	
Continuity and enclosure	Morphology	The morphology reveals that there is little permeability along the Marlowes, particularly between the Marlowes and the area to the east. These large blocks, designed for modernist buildings in open space, have become littered with car parking that further reduce the east-west connectivity. New approaches should include improved block permeability.	40-41	
	Building Lines	The town centre shows a range of approaches to the building lines. The civic and educational area shows the buildings set far back from the west side of the Marlowes, whereas the east side has building line which shifts between medium and large setbacks. The pedestrianised area of the Marlowes and the Old Town both have consistent building lines. Waterhouse Street has many gaps and setbacks along its length. There would be value to improving the pedestrian experience by introducing more continuous building lines on Waterhouse Street and the Marlowes.	42	47-49
	Building Orientation	The fronts of building should be facing the street , with entrances accessible from the pavement, particularly along Waterhouse Street.	42	
	Pavements	A new approach to the pedestrianised pavement of the Marlowes, such as introducing a more rationalised low-rise use to the middle of the pavement (such as the market) would potentially create a more organised use of the pavement.		
	Pattern of open space	The Water Gardens should be much more integrated with the Marlowes, particularly through the facilitation of more east-west connectivity.	44	28-29
Making Connections	Circulation, demand and linkages	The Marlowes acts as the local distributor (High Street), with the lower half pedestrianised. Waterhouse Street has become a street for servicing the retail buildings and bus activity. The street has great potential as the 'recreational' complement to the Marlowes shopping street. The Marlowes also has primary and district distributors which run off feed into it. Leighton Buzzard Road is a primary distributor which currently acts as a barrier to the town centre. The 'magic roundabout' is a major barrier to the town centre.	46-47	50-52
	Parking	Opportunities to reduce surface car parking should be encouraged, particularly in relation to the civic and educational uses.	48	53-54
	Land Use	There is potential to create new mixed used developments in the heart of the town centre. There are could be opportunities to develop new land uses on Waterhouse Street which add vitality to the area around the Water Gardens.	45	
Quality of the public realm	Streetscape elements	Streetscape elements should fit the character of the Conservation Area in the Old Town. The New Town Centre should limit street furniture clutter and strive to have modern design.	50	55-57
	Quality of open space	Greenery should be integrated into the town centre where possible.	44	58-59

CASE STUDIES: TOWN CENTRE ZONE - INFILL SITES

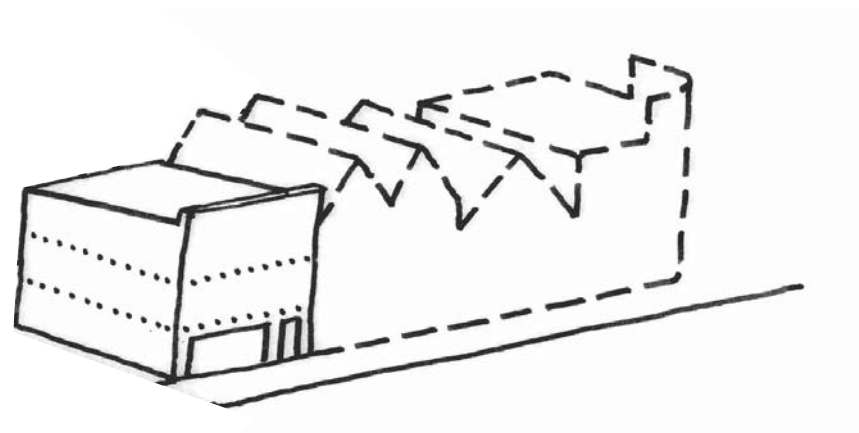

CASE STUDY TC1: Typical density

This case study shows a three-storey infill building with no setback. This approach could apply to any area within the town centre. It is assumed that car parking would occur on-street or in nearby existing car parks.

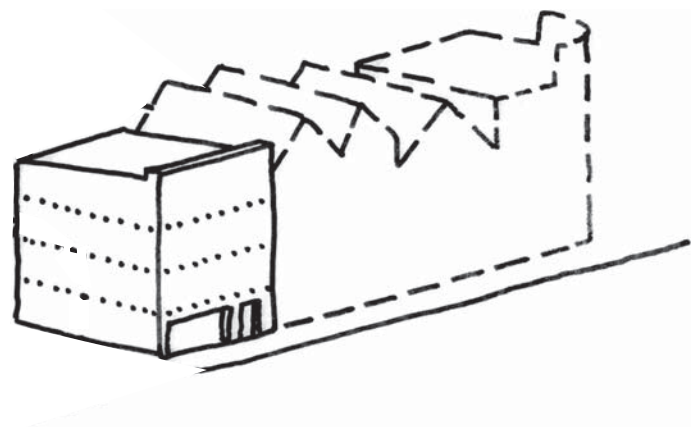

CASE STUDY TC2: Enhanced density

This case study shows a four-storey infill building with no setback. Four storey buildings would not be applicable to the Old Town. It is assumed that car parking would occur on-street or in nearby existing car parks.

CASE STUDIES: TOWN CENTRE ZONE - BLOCK SITES

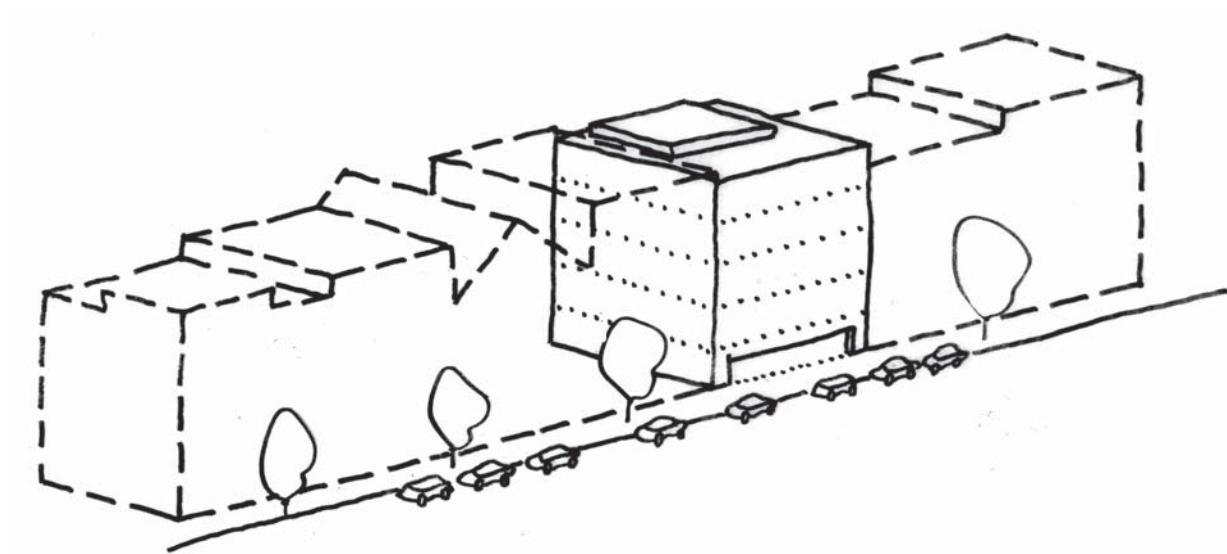

CASE STUDY TC1: Enhanced density

This case study shows a five-storey building frontage. It is assumed that any building of this height would require large commercial footprints with on-site parking, requiring 'block-sized' sites. This case study is most directed toward the market area and the civic and educational area.

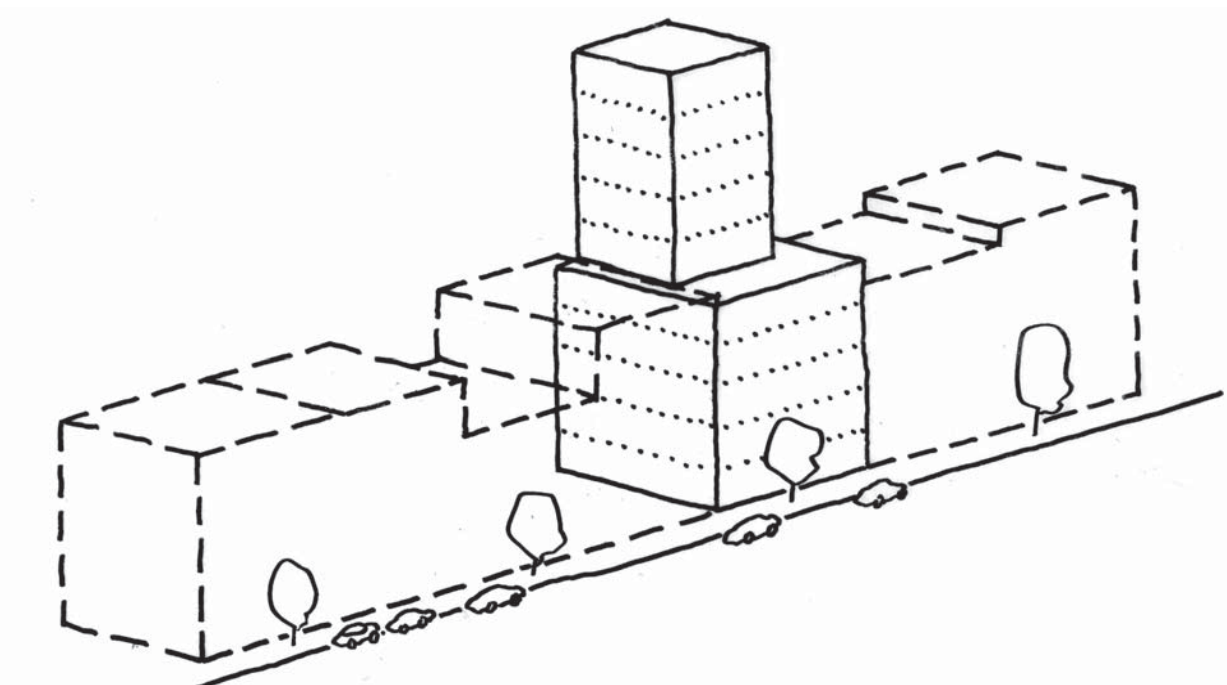

CASE STUDY TC2: Increased density

This case study shows a five-storey building frontage with an additional five-storey setback. This drawing addresses the possibility that Hemel Hempstead could potentially introduce major new densities into the town centre, as part of an integrated street-front, not simply as an isolated development. It is assumed that any building of this height would require large commercial footprints with on-site parking, requiring 'block-sized' sites. This case study is most directed toward the market area and the civic and educational area.

URBAN DESIGN GUIDELINES: INNER ZONE

	Criteria	Guidelines	Page Reference	Photo Reference
Making places	Building types	The existing building types are primarily two-storey terrace buildings. The primary typologies should continue to be terrace buildings . There could be potential opportunities on large block sites for three-storey terrace buildings .		
	Materials / architectural styles	The inner zone buildings are predominantly brick buildings. Traditional brickwork should be favoured over modern wirecut bricks. Clay tile or slate roofing material should be encouraged. Roofs could be pitched or emphasise the front facades.	30-32	42-43
	Listed buildings/ Conservation Area	There are a few listed buildings within this zone, and there is currently no Conservation Area that encompasses this broadly Victorian terraced zone. It may be worth considering certain parts of this zone as worthy of a Conservation Area.	33-35	
	Building Heights	Buildings should generally be two-storeys . New blocks that are potential sites of increased density could include three-storey buildings .	36	
	Density	The existing densities are high or very high. In general the area's density should be high, with potential opportunities in new block sites to have very high (60+) densities.	37-38	44-46
	Topography	There are several strong views from and across this zone given its general location in the river valley and along the Canal. The strong views include toward St Mary's Church from the southeast, into the town centre and toward the Canal.	39	
Continuity and enclosure	Morphology	The existing Victorian street grid - which has facilitated low-rise high density terrace housing should be continued where possible.	40-41	
	Building Lines	The existing buildings generally have minimal setbacks. Developments within the zone should continue to have minimal setbacks.	42	47-49
	Building Orientation	The fronts of building should be facing the street , with entrances accessible from the pavement.	42	
	Pavements	All new developments should have pavements along the roads. Efforts should be made to discourage cars from parking along the pavement.		
	Pattern of open space	Houses should have rear gardens that back onto other rear gardens as a means of maximising wildlife habitat, privacy and sunlight. Front gardens should be individual. New developments adjacent to the recreation ground should encourage houses that front the open space, creating positive overlooking.	44	28-29
Making connections	Circulation, demand and linkages	The streets within the inner zone are residential access roads, allowing the zone to be relatively free of through traffic. Given the zone's generally narrow Victorian streets, it is important to minimise cut-throughs.	46-47	50-52
	Parking	Street widths are quite narrow in this zone along many of the Victorian streets, often in the range of six metres. This narrowness can encourage cars parking along the pavements. Any new developments within this zone should have on-site parking.	48	53-54
	Land Use	N/A	45	
Quality of the public realm	Streetscape elements	Streetlighting on the roads should be improved.	50	55-57
	Quality of open space	There is little open land within these predominantly Victorian areas, but there is good access to open land outside of the zone.	44	58-59

* Photo references correspond to page numbers within the associated photo log.

CASE STUDIES: INNER ZONE - INFILL SITES

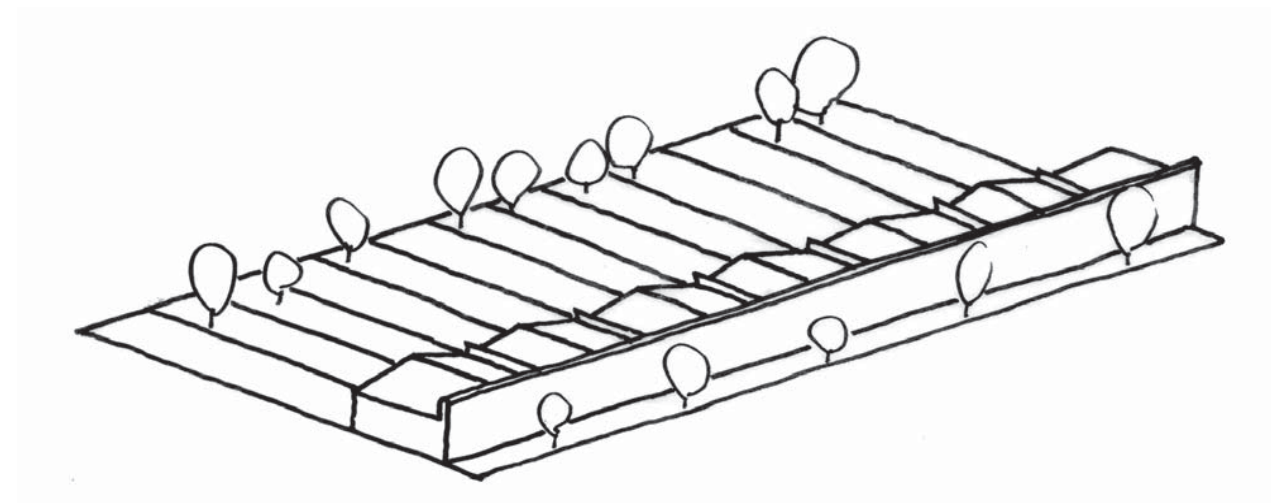

CASE STUDY I1: Typical density

This case study shows the typical two-storey terrace housing. On streets that are wide enough, on-street parking would be appropriate.

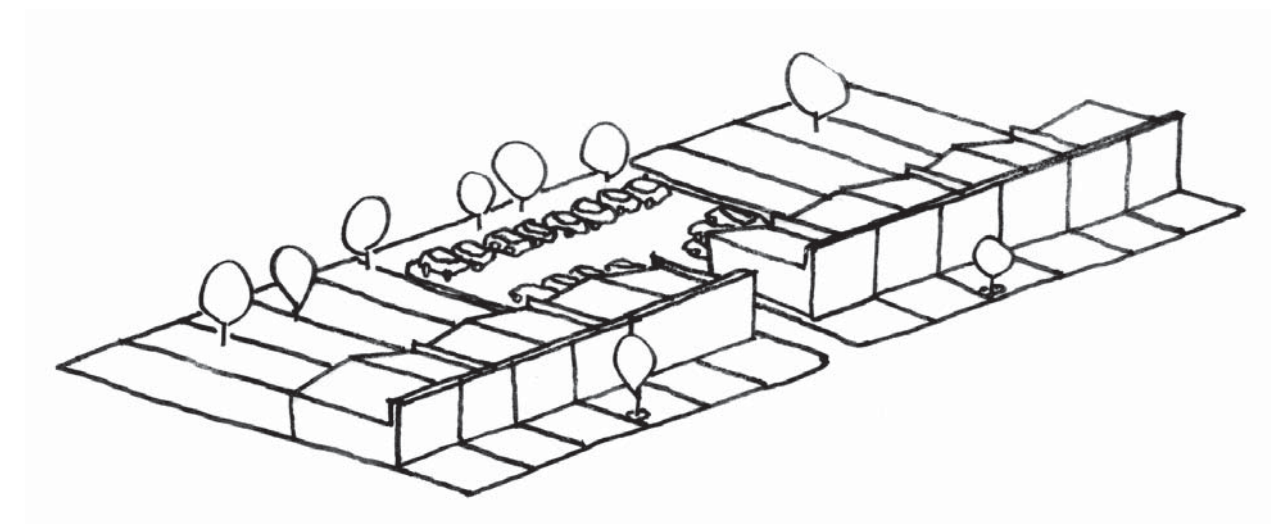

CASE STUDY I2: Typical density

This case study shows the terrace housing with communal parking. On-site communal parking would relieve the pressure on the inner zone's narrow streets.

CASE STUDIES: INNER ZONE - BLOCK SITES

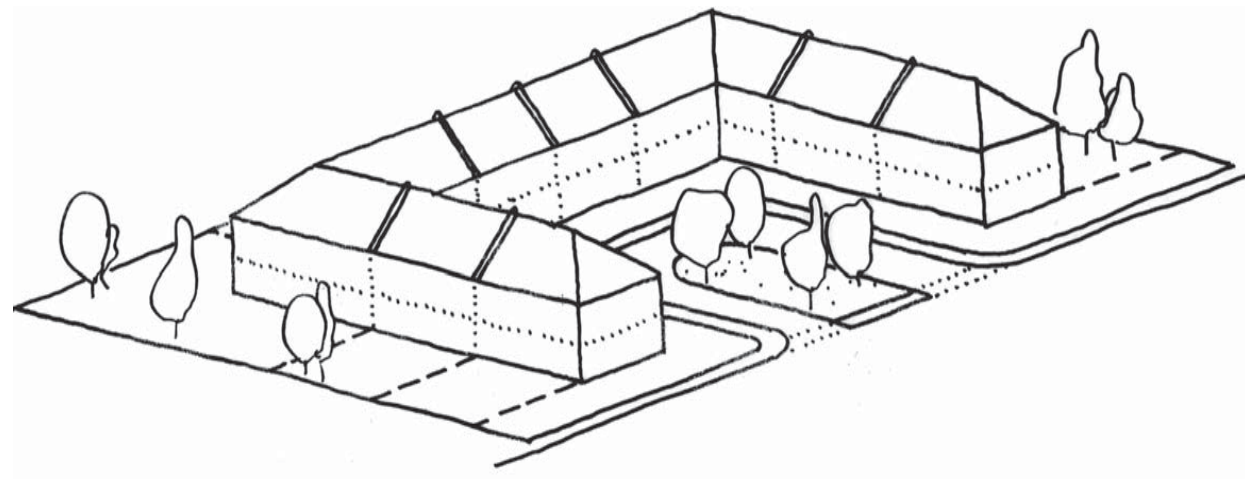

CASE STUDY I1: Typical density

This case study shows a two-storey close development. Close developments can facilitate new 'block' developments where there is no space for gridded through streets while still providing public space and street frontage. It is assumed that car parking would occur along the close and on-street, unless narrow existing street widths dictated that parking should occur on-site or if the site is along a distributor road.

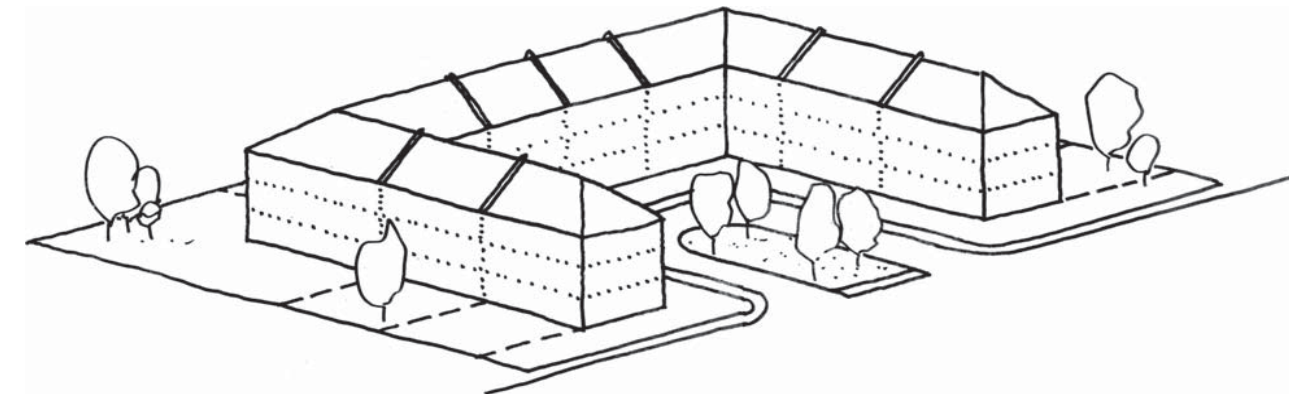

CASE STUDY I3: Enhanced density

This case study shows a three-storey close development which would typically have garden maisonettes and third-floor flats or garden flats and duplexes above. With the enhanced densities, on-site parking would most likely need to be provided. This scenario would be a logical option for undercroft parking.

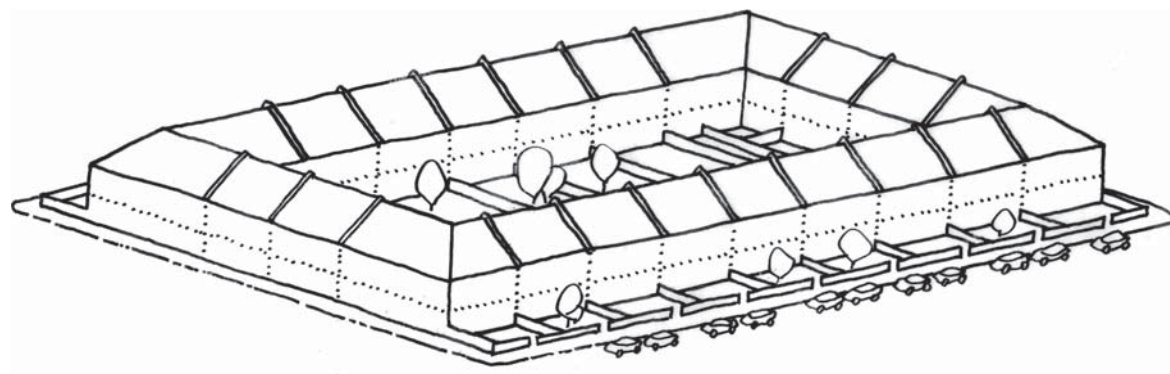

CASE STUDY I2: Typical density

This case study shows the two-storey terrace blocks typical of what already exists in the inner zone. It is assumed that car parking would occur along the close and on-street, unless narrow existing street widths dictated that parking should occur on-site or if the site is along a distributor road.

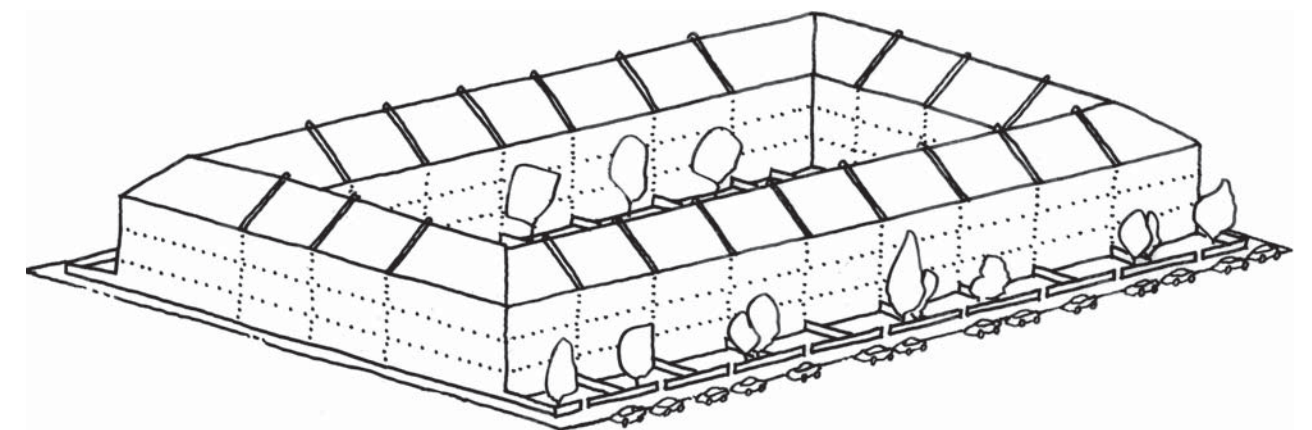

CASE STUDY I4: Increased density

This case study shows three-storey terrace housing which would typically have garden maisonettes and third-floor flats or garden flats and duplexes above. This increased density case study would be best applied when within 400 metres of shops, services or major transit links. With the increased densities, on-site parking would most likely need to be provided. This scenario would be a logical option for undercroft parking.

URBAN DESIGN GUIDELINES: NEW TOWN NEIGHBOURHOOD ZONE

	Criteria	Guidelines	Page Reference	Photo Reference
Making places	Building types	The neighbourhoods were intentionally planned with a range of building types, including detached and semi-detached houses, and two- three-storey terrace building. This range of building types should be encouraged, although detached buildings should be discouraged.		
	Materials / architectural styles	The New Town neighbourhoods were all built from around 1950 predominantly yellow London stock bricks and tar shingle pitched roofs. The residents have frequently complained of the bland nature of the design. Modern styles and materials would enliven the neighbourhoods.	30-32	42-43
	Listed buildings/ Conservation Area	N/A	33-35	
	Building Heights	Buildings should typically be two-three storeys . There may be opportunities to develop four-storey buildings on block sites of 'increased density'.	36	
	Density	As a result of the range of typologies the densities range from low to very high. While it is important that the neighbourhoods maintain a diversity of typologies, the zone could potentially become slightly more dense, ranging from medium to very high densities.	37-38	44-46
	Topography	Many of the neighbourhoods have strong views from the open land contained within them, including Warners End, Shrub Hill Common and Highfield. Views from the open land should be protected.	39	
Continuity and enclosure	Morphology	The existing street morphology is predominantly curvilinear with large residential blocks. Many of these blocks have permeable pedestrian paths, some of which lead into residential courtyards. These large, curvilinear blocks should be protected, with new backland developments built along the lines of the earlier courtyard models connected by footpaths.	40-41	
	Building Lines	The existing buildings generally have medium setbacks, providing either private front gardens (typically in conjunction with detached or semi-detached houses) or communal front gardens (generally in conjunction with the terrace housing). These patterns should continue.	42	47-49
	Building Orientation	The fronts of building should be facing the street in a uniform manner, with entrances accessible from the pavement.	42	
	Pavements	All new developments should have pavements along the roads.		
	Pattern of open space	Houses should have rear gardens that back onto other rear gardens as a means of maximising wildlife habitat, privacy and sunlight. Front gardens could be communal or individual. Given the curvilinear nature of the streets there are also various pieces of open space along the roads. These areas should be preserved.	44	28-29
Making connections	Circulation, demand and linkages	The new neighbourhoods have a relatively clear hierarchy of roads, with a series of district distributor roads - such as Adeyfield Road and Longlands - running along the perimeter of the neighbourhoods. These perimeter roads minimise the amount of traffic running through the neighbourhood access roads. There are concerns for the traffic impacts of the primary distributors (St Albans Road and Queensway) on these district distributors. Attempts should be made to limit district distributor traffic to neighbourhood connections, and further efforts should prevent neighbourhood cut-through activity.	46-47	50-52
	Parking	On-site communal and individual parking is generally allotted, depending on typology. On-site parking is encouraged.	48	53-54
	Land Use	The neighbourhoods have local centres, which range in size from 2-3 shops with services and 10 or so shops with services. While the centres are frequently cited as bland design, they provide an important function. The local centres should be protected and improved. There are schools within each neighbourhood, facilitating easier walks to schools. Sizable new developments (of over 500 dwellings) should consider the development of a school and a local centre.	45	
Quality of the public realm	Streetscape elements	Streetlighting on the roads should be improved. There are opportunities for 'amenity clusters' of lighting, benches, plantings and garbage bins in some of the small open spaces along the streets.	50	55-57
	Quality of open space	There should be strong connections to the open land within the neighbourhoods. Long footpaths that interconnect neighbourhoods (such as the disused rail track that runs through Highfield) and connect to the Green Belt should be encouraged.	44	58-59

* Photo references correspond to page numbers within the associated photo log.

CASE STUDIES: NEW TOWN NEIGHBOURHOOD ZONE - INFILL SITES

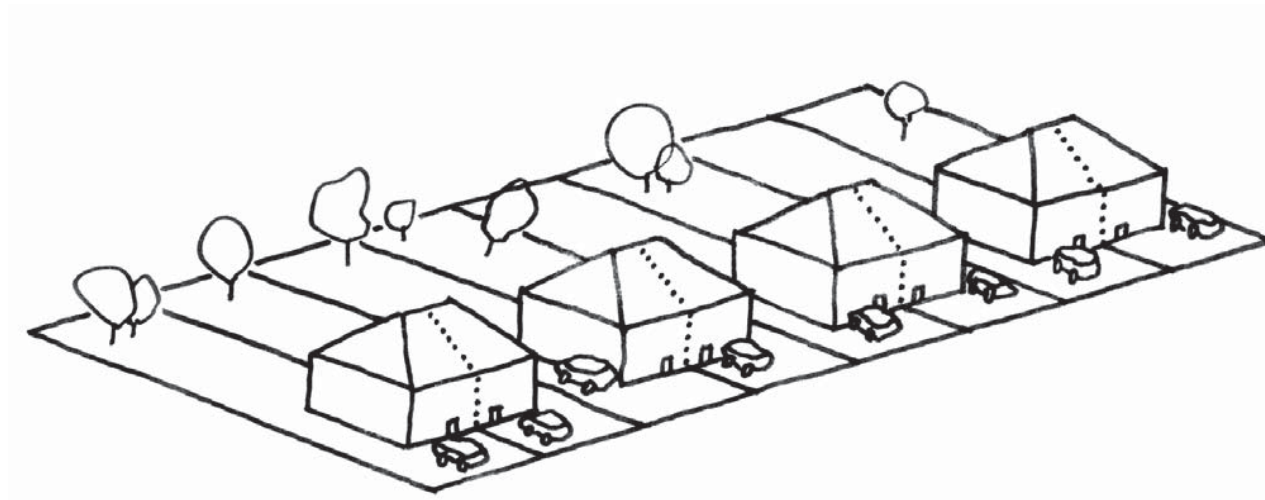

CASE STUDY NTN1: Typical density

This case study shows semi-detached housing with medium setbacks and on-site individual parking.

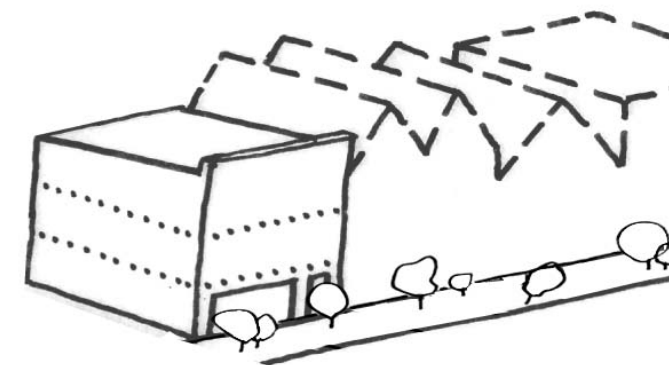

CASE STUDY NTN3: Enhanced density

This case study shows semi-detached housing with medium setbacks and on-site individual parking.

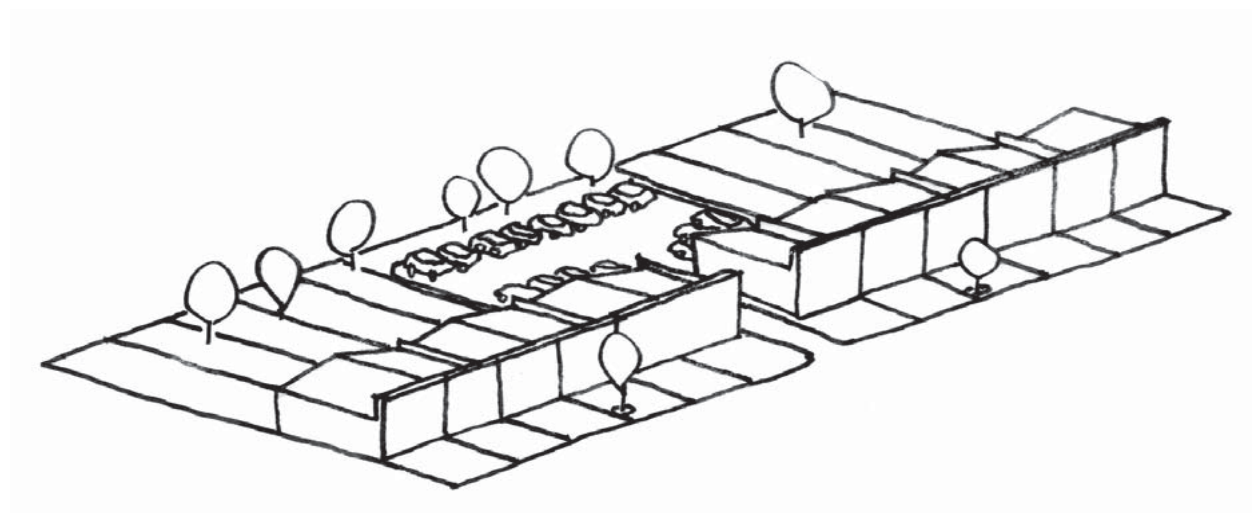

CASE STUDY NTN2: Typical density

This case study shows terrace housing with medium setbacks and on-site communal parking.

CASE STUDIES: NEW TOWN NEIGHBOURHOOD ZONE - BLOCK SITES

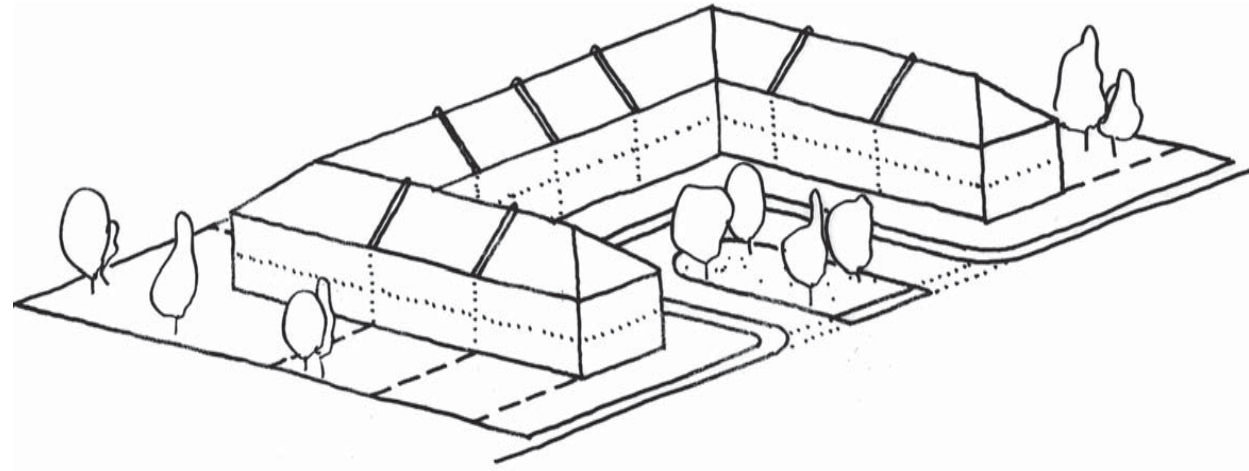

CASE STUDY NTN1: Typical density

This case study shows a two-storey close development. Close developments can facilitate new 'block' developments where there is no space for gridded through streets while still providing public space and street frontage. It is assumed that car parking would occur along the close and on-street, unless narrow existing street widths dictated that parking should occur on-site.

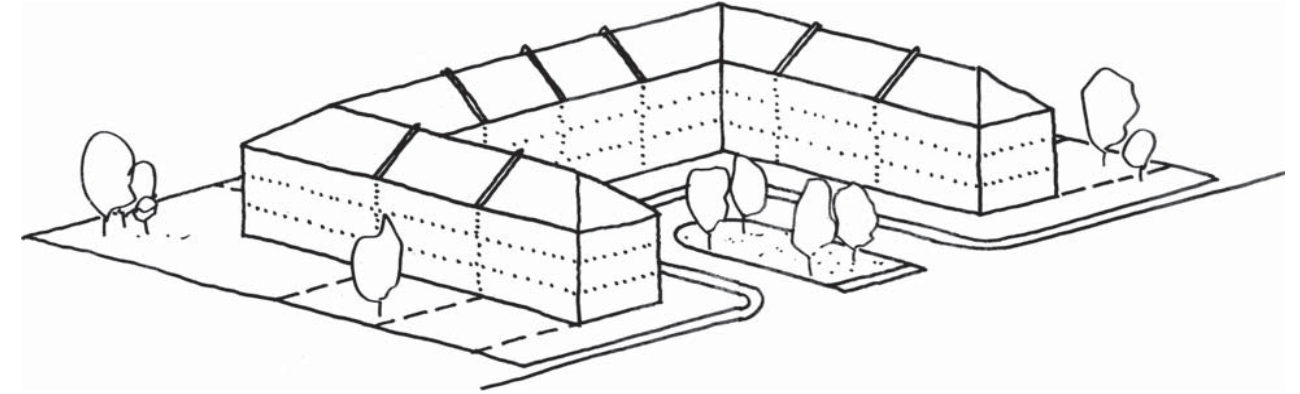

CASE STUDY NTN3: Enhanced density

This case study shows a three-storey close development which would typically have garden maisonettes and third-floor flats or garden flats and duplexes above. With the enhanced densities, on-site parking would most likely need to be provided. This scenario would be a logical option for undercroft parking.

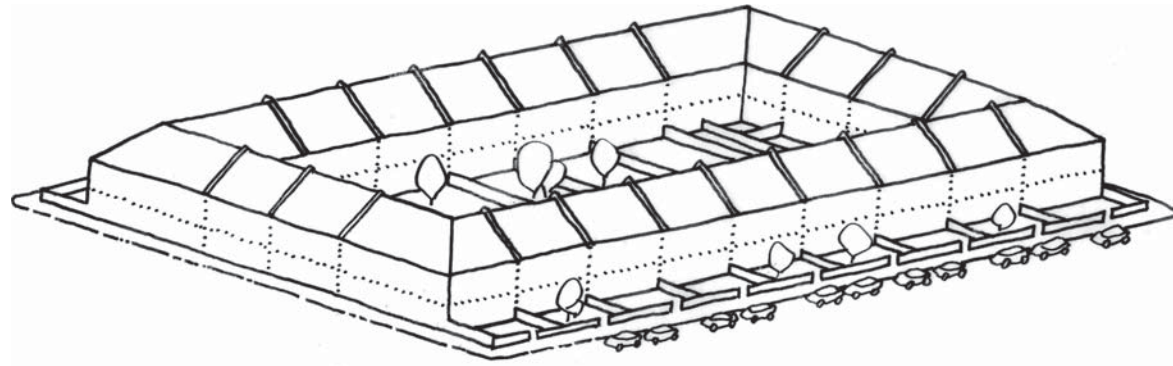

CASE STUDY NTN2: Typical density

This case study shows the two-storey terrace blocks typical of what already exists in the inner zone. It is assumed that car parking would occur on-street unless narrow existing street widths dictated that parking should occur on-site or because the site is along a distributor road.

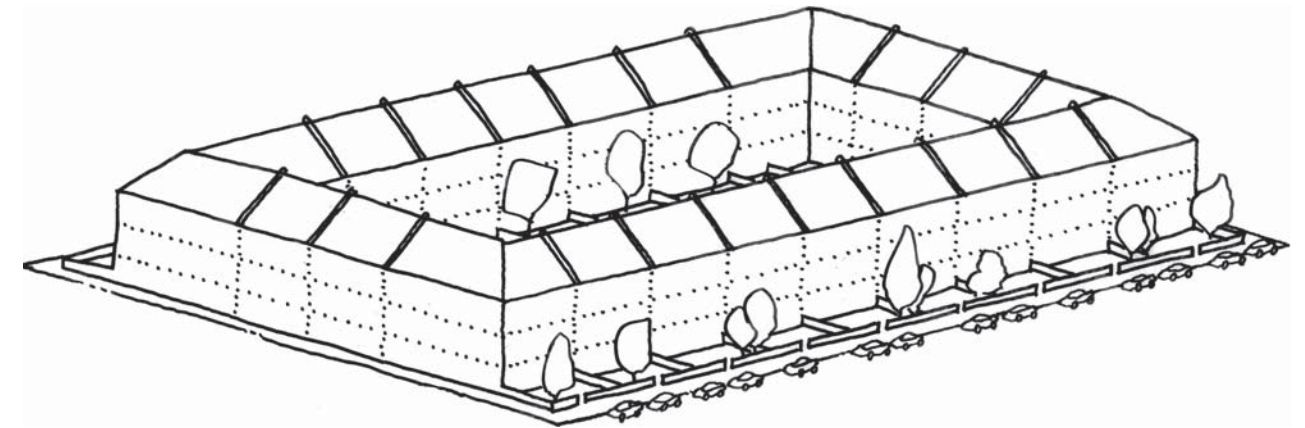

CASE STUDY NTN4: Enhanced density

This case study shows three-storey terrace housing which would typically have garden maisonettes and third-floor flats or garden flats and duplexes above. With the enhanced densities, on-site parking would most likely need to be provided. This scenario would be a logical option for undercroft parking.

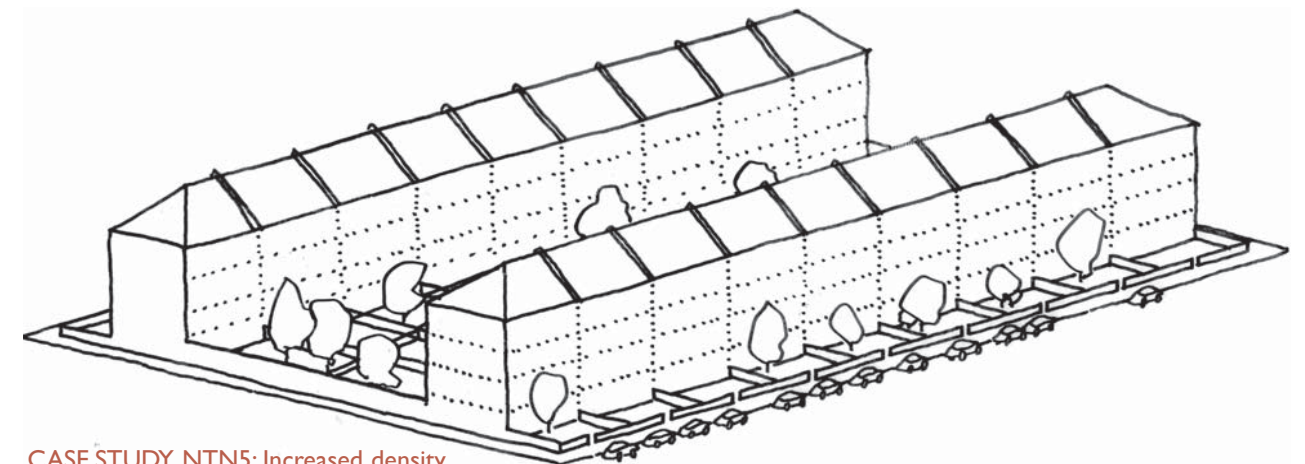

CASE STUDY NTN5: Increased density

This case study shows four-storey terraces. This increased density case study would be best applied when within 400 metres of shops, services or major transit links. With the increased densities, on-site parking would most likely need to be provided. This scenario would be a logical option for undercroft parking.

URBAN DESIGN GUIDELINES: PERIPHERAL ZONE

	Criteria	Guidelines	Page Reference	Photo Reference
Making places	Building types	The existing building types are primarily two-storey detached houses. The primary typologies should be semi-detached or detached buildings .		
	Materials / architectural styles	The peripheral zone buildings are generally brick buildings, and brick buildings that utilise traditional brickwork would be recommended. Pitched roofs would be preferred over flat roofs in new developments.	30-32	42-43
	Listed buildings/ Conservation Area	N/A	33-35	
	Building Heights	Buildings should be two-storeys .	36	
	Density	The existing densities are generally very low. In general the area's density should be low to medium.	37-38	44-46
	Topography	Views into the Green Belt should be protected.	39	
Continuity and enclosure	Morphology	The existing street morphology is predominantly cul-de-sacs. The creation of through streets should be encouraged where possible. Close block developments should be encouraged over cul-de-sac developments.	40-41	
	Building Lines	The existing buildings generally have large, irregular setbacks. New developments do not need to establish a consistent building line, but the plot sizes could be significantly reduced.	42	47-49
	Building Orientation	The fronts of buildings need not face the street.	42	
	Pavements	All new developments should have pavements along the roads.		
	Pattern of open space	Houses should have rear gardens that back onto other rear gardens as a means of maximising wildlife habitat, privacy and sunlight. Front gardens are typically private in this zone and any new development should maintain this characteristic.	44	28-29
Making connections	Circulation, demand and linkages	The peripheral zone sites are typically located at a distance from primary and district distributors, allowing them to avoid cut-through traffic. While this characteristic useful, more local through streets would reduce the perception of these areas being private enclaves.	46-47	50-52
	Parking	Due to the peripheral and semi-rural nature of this zone, on-street parking should be discouraged in favour of on-site car parking in front of individual houses.	48	53-54
	Land Use	N/A	45	
Quality of the public realm	Streetscape elements	Streetlighting on the roads should be improved.	50	55-57
	Quality of open space	Connections to open land, particularly the Green Belt should be facilitated.	44	58-59

* Photo references correspond to page numbers within the associated photo log.

CASE STUDIES: PERIPHERAL ZONE - INFILL SITES

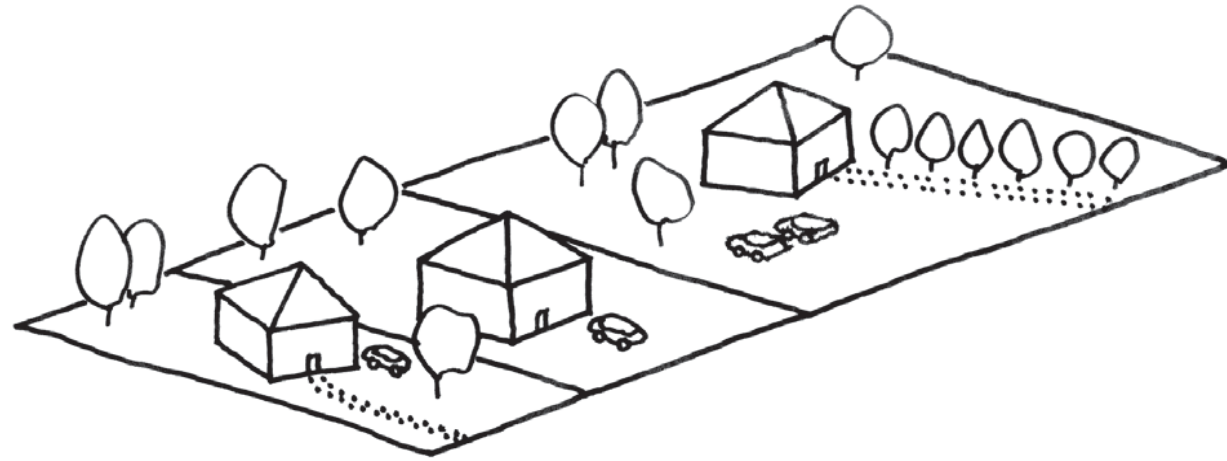

CASE STUDY P1: Typical density

This case study shows detached housing with large irregular setbacks, building orientations that do not necessarily front the street and on-site individual parking.

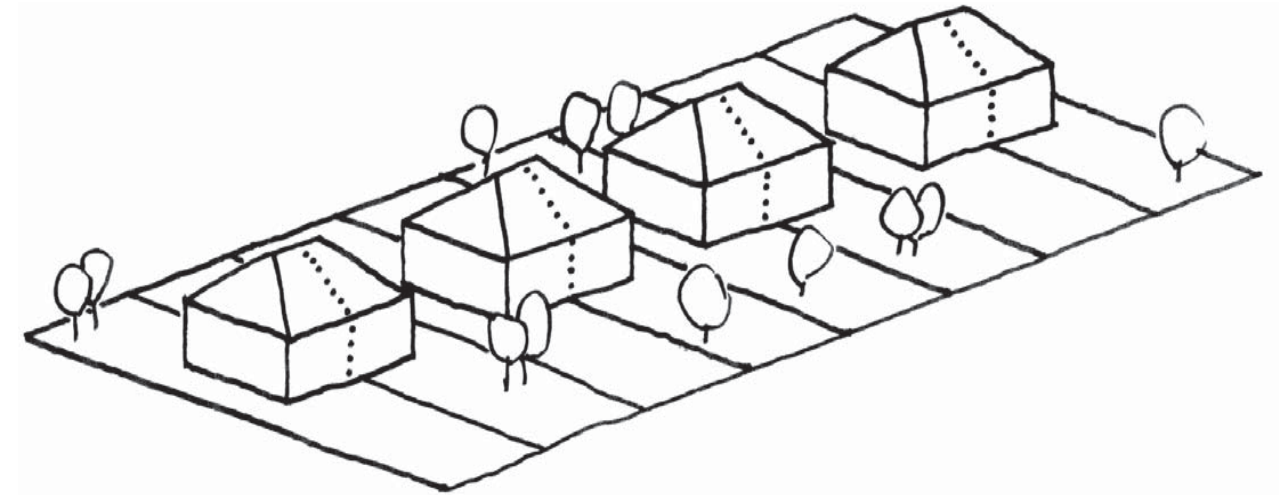

CASE STUDY P3: Enhanced density

This case study shows semi-detached housing with large setbacks and on-site individual parking.

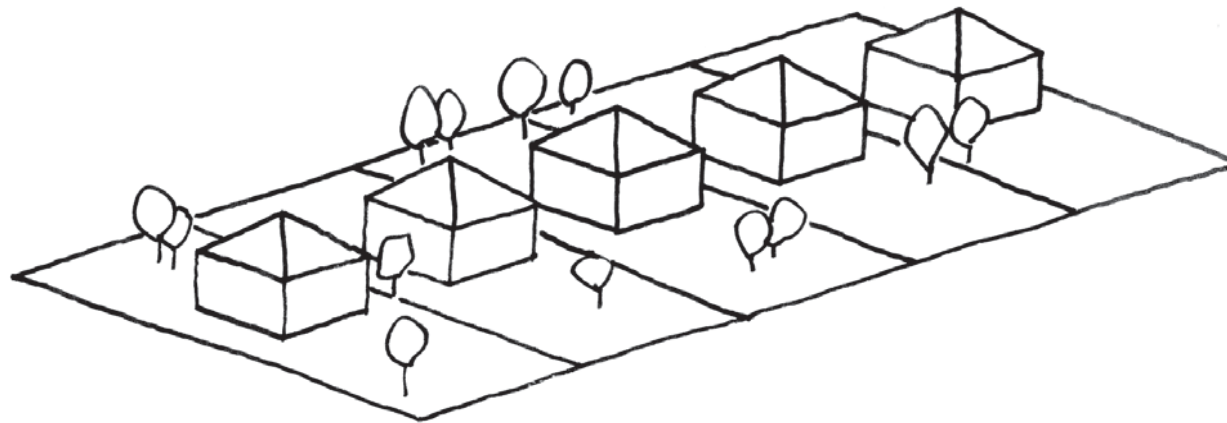

CASE STUDY P2: Typical density

This case study shows semi-detached housing with large setbacks and on-site parking.

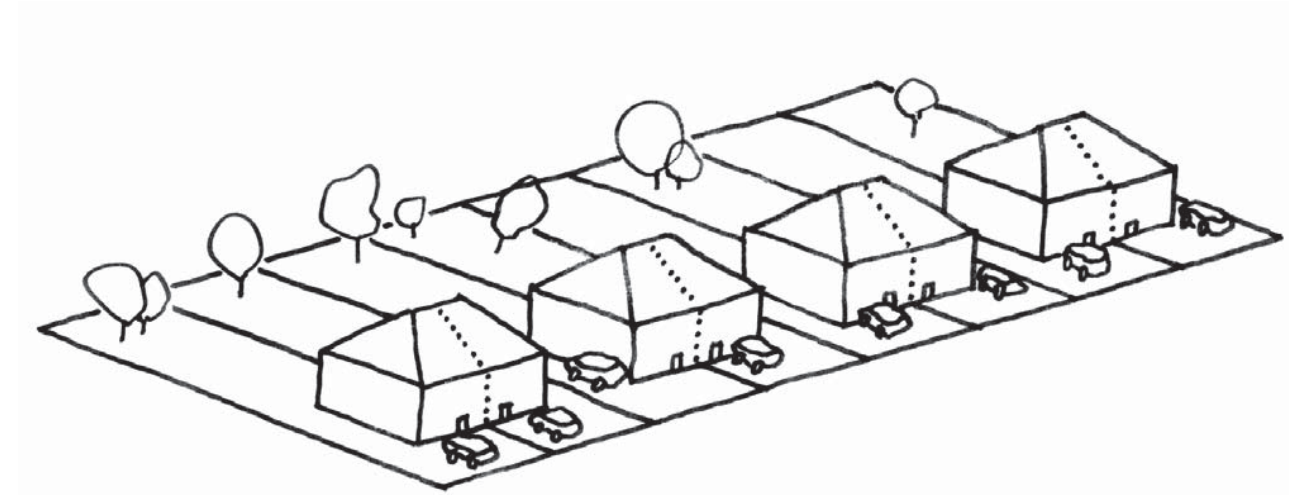

CASE STUDY P4: Increased density

This case study shows semi-detached housing with medium setbacks and on-site individual parking.

CASE STUDIES: PERIPHERAL ZONE - BLOCK SITES

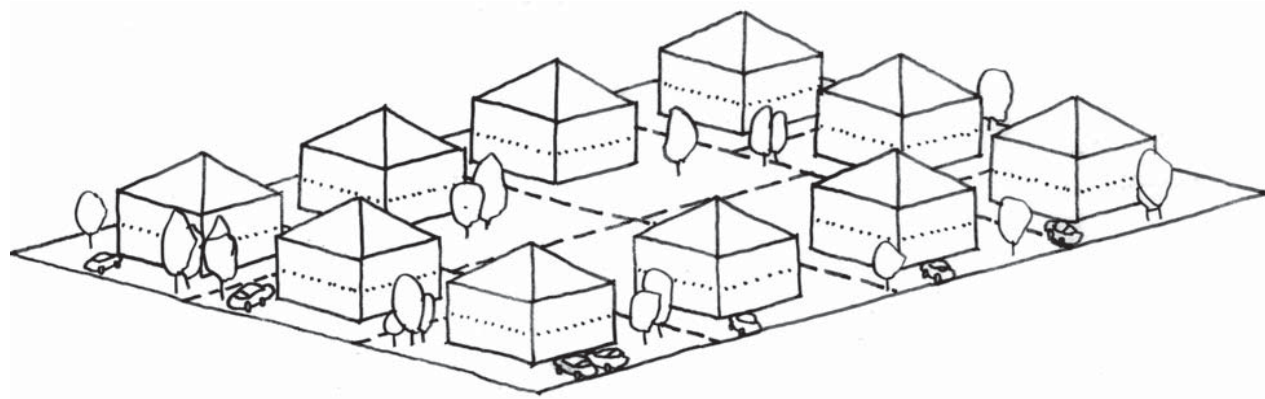

CASE STUDY P1: Enhanced density

This case study shows a perimeter block of detached housing with medium setbacks and on-site individual parking.

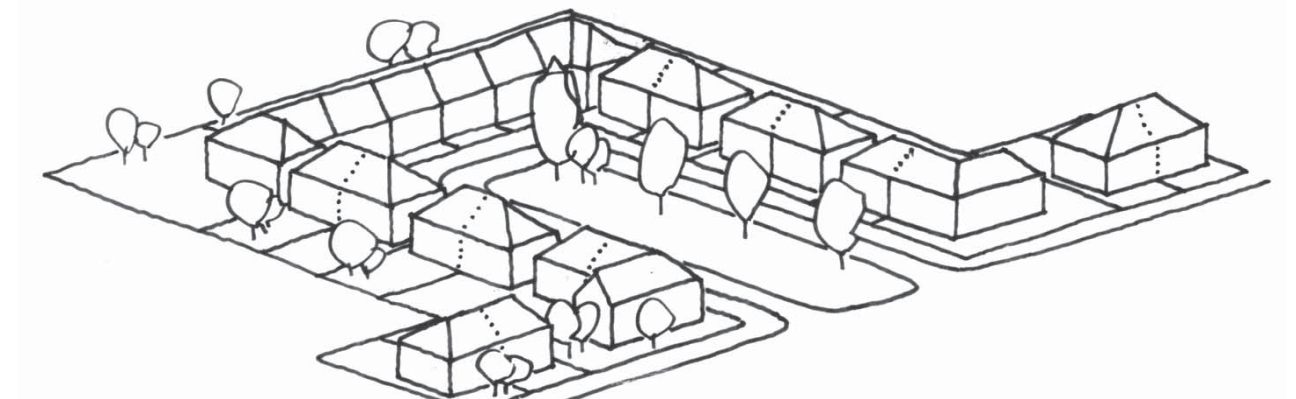

CASE STUDY P3: Increased density

This case study shows semi-detached housing in a two-storey close development. This increased density case study would be best applied when within 400 metres of shops, services or major transit links. Given the semi-rural character of this zone, parking should occur on-site.

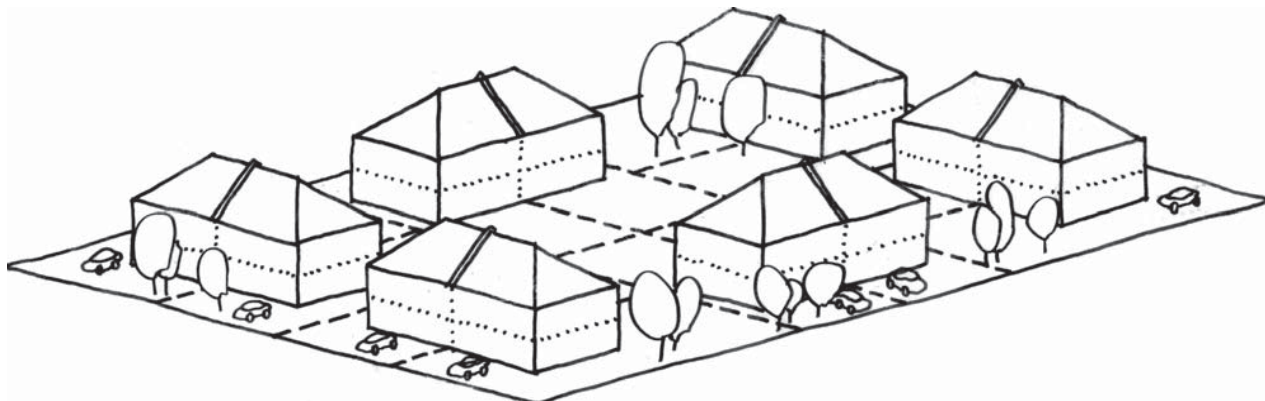

CASE STUDY P2: Enhanced density

This case study shows a perimeter block of semi-detached housing with medium setbacks and on-site parking.

URBAN DESIGN GUIDELINES: EMPLOYMENT ZONE

	Criteria	Guidelines	Page Reference	Photo Reference
Making places	Building types	The existing building types are either industrial buildings, or in the case of Apsley, Victorian residential terrace buildings mixed with old warehouses. New buildings could be 3-4 four storey terrace flat buildings of one unit's width.		
	Materials / architectural styles	There is a wide range of styles and materials. The residential buildings tend to be predominantly brick.	30-32	42-43
	Listed buildings/ Conservation Area	There are a few select listed buildings in the Apsley area.	33-35	
	Building Heights	Building conversions occurring within the Employment zone have the potential to be three-four storeys.	36	
	Density	The existing densities vary depending on the amount of employment activity. Densities could increase considerably in Apsley.	37-38	44-46
	Topography	There are significant views across the Apsley area from the north into the Green Belt. Any new buildings should be reviewed with these viewpoints in mind.	39	
Continuity and enclosure	Morphology	The nature of the Employment areas has demanded large blocks to accommodate the industrial building footprints. This morphology would allow for conversion to residential areas that are built along through streets. The use of through streets is encouraged over the development of cul-de-sacs.	40-41	
	Building Lines	The large industrial buildings have created uneven building lines designed to accommodate servicing and parking. Any new residential development should strive to create continuous active street frontages.	42	47-49
	Building Orientation	The fronts of building should be facing the street in a uniform manner, with entrances accessible from the pavement.	42	
	Pavements	All new developments should have pavements along the roads.		
	Pattern of open space	The large blocks would allow for new open land and wildlife corridors - particularly in connection to the Grand Union Canal and the Green Belt.	44	28-29
Making connections	Circulation, demand and linkages	Both major employment areas are well-connected to primary distributor roads. Any residential development would require a carefully managed hierarchy to prevent cut-through traffic.	46-47	50-52
	Parking	Given the potential for new high density development, parking should be created on-site.	48	53-54
	Land Use	There is a tremendous potential for new mixed use high density development in Apsley which promotes walkable neighbourhoods with ground floor retail, live/work units, and local employment sites.	45	
Quality of the public realm	Streetscape elements	With the potential for new high density development, streetscape improvements would be of tremendous importance. These improvements would focus on lighting, signage, and basic amenities such as benches and rubbish bins.	50	55-57
	Quality of open space	New developments in Apsley should consider the Grand Union Canal as a major recreational amenity for the area, and footpath connections to the canal towpath should be made.	44	58-59

* Photo references correspond to page numbers within the associated photo log.