



Means of Access and Transport Appraisal

for

Land at Fields End, Hemel Hempstead,
Herts, HPI 2JQ

Grid Reference: 503055E, 207270N

Prepared on behalf of
Taylor Wimpey Strategic Land, Barratt North
London Ltd and Hertfordshire Property

May 2012

Reference: ST-2189/ATSA/1205-Fields End

Revision 3

This report has been prepared by Stomor Ltd based upon information obtained from others. Stomor Ltd cannot be held responsible for inaccuracies in this information.

Drawings contained in this report are based upon information available at the time of production and serve to demonstrate that access can be suitably provided. The information produced by Stomor Ltd for this report should not be used as detailed design for construction purposes.

This report has been prepared for the Client for his sole and specific use. No professional liability or warranty shall be extended to other parties in connection with this report without the explicit written agreement of Stomor Ltd and payment of the appropriate fee.

Should the Client wish to pass copies of this report to others for information, the entire report should be copied.



<i>Revision</i>	<i>Author</i>	<i>Checked by</i>	<i>Issue Date</i>
<i>0</i>	<i>DGS</i>	<i>NJM</i>	<i>23.05.12</i>
<i>1</i>	<i>DGS</i>	<i>NJM</i>	<i>15.06.12</i>
<i>2</i>	<i>DGS</i>	<i>NJM</i>	<i>23.07.12</i>
<i>3</i>	<i>DGS</i>	<i>NJM</i>	<i>16.08.12</i>

CONTENTS

1.	Introduction	Page 1
2.	Site Information	Page 3
3.	Site Inspection of Surrounding Road Network	Page 4
4.	Existing Public Transport and Other Facilities	Page 8
5.	Personal Injury Accident Records	Page 10
6.	Development Proposals	Page 12
7.	Means of Access Proposals	Page 14
8.	Current Traffic Flows on links and junctions within the Study Area	Page 19
9.	Development Trip Generation and Distribution	Page 22
10.	Assessment Years and Growth	Page 28
11.	Discussion on Implications to the Wider Road Network	Page 29
12.	Conclusions	Page 42

APPENDICES

- A Site Location Plan Drawing ST-2189-22
- B Land Ownership Plan Number 4107 301
- C Aerial View of the Site
- D Highway Boundary Plans
- E Personal Injury Accidents Details
- F Means of Access Plans Drawing Nos. ST-2189-1-A and 23-B
- G Stomor letter to Highway Authority 22nd March 2012, and confirmation of acceptable trip rates by the Highway Authority.
- H Classified Traffic Count/Queues Drawings ST-2189-16, 17 and 28
- I Stomor Drawing ST-2189-24 Year 2012 Arcady Runs - Junction 2
- J Stomor Drawings ST-2189-11-A, 12, 13, and 14
- K Stomor Drawings ST-2189-15, 18, 19, 20, 21
- L Picady Runs – Junction 1
- M Arcady Results – Junction 2
- N Stomor Drawing ST-2189-25 – Junction 3
- O Stomor Drawing ST-2189-26 – Junction 4 and 5 minis, feasibility Linsig Output and Drawing ST-2189-29.
- P Stomor Drawing ST-2189-27-A – Junction 6

1 Introduction

- 1.1 Stomor Ltd has been commissioned by Taylor Wimpey Strategic Land, to undertake a means of access, transport and sustainability appraisal for land at Fields End, Hemel Hempstead, Herts.
- 1.2 This report will cover investigations associated with potential new residential and associated development at the site, including assessment of access arrangements available to serve the site from the surrounding road network.
- 1.3 The site is located in the Warners End and Chaulden areas to the west of Hemel Hempstead, south of Fields End Farm and north of the River Bulbourne. A site location plan is provided in **Appendix A**.
- 1.4 The site occupies an area of approximately 51 hectares, and incorporates three ownerships; Taylor Wimpey/Gardener Family, Barratt North London, and Hertfordshire County Council (HCC). Details are shown on Land Ownership Plan Number 4107 301. A copy of this plan is attached in **Appendix B**.
- 1.5 The site is expected to be developed primarily with residential housing up to 900 units. In addition, a 2FE primary school and community uses including a doctors surgery would be provided within the development. Significant areas of landscaping, open space and recreation areas will also be provided. An important factor to be considered is that the proposals are intended to make the best use of land, particularly within the green belt, in accordance with current government guidelines.
- 1.6 However, there are other factors mainly relating to the existing highway network which will have a significant effect on the actual practical achievable level of development. The following appraisal report will provide guidance into the level of development which could potentially be served from the surrounding road network.
- 1.7 It should be noted that except for the area of the site adjacent to Long Chaulden, the above investigations are based upon visual inspection of the site, and Ordnance Survey base data. A full topographical survey will be required to validate the layout of any of the improvement proposals provided.
- 1.8 Analysis of the site capacity has been carried out in relation to the feasible accesses into the site, and nature of the surrounding highway network. Indicative drawings have been prepared to demonstrate how the site can be accessed, along with any necessary

improvement works required. In addition, our outline views will be given on the implication of the developments on the wider road network.

2 Site Information

- 2.1 The site is greenfield in nature, and appears to be used for arable agricultural purposes. Trees and mature hedges are located around the boundary of the site. In addition, trees and hedges are located within the site which form various field boundaries
- 2.2 Long Chaulden abuts the eastern side of the site, Chaulden Lane abuts the south boundary, and Pouchen Lane abuts the west and northwest sides.
- 2.3 Various other roads approach the site along the eastern boundary, all of which serve various residential areas.
- 2.4 Hemel Hempstead Public Footpath 020 currently runs just within the site along the eastern boundary, linking areas to the south east of Long Chaulden through to Fields End Lane.
- 2.5 Hemel Hempstead Public Footpath 091 currently runs just within the site just to the north of Honeycross Road/Musk Hill. It then runs to the northwest linking to Pouchen End Lane on the west boundary of the site.
- 2.6 The site is currently accessed by various gated field entrances around the site for use by agricultural and maintenance vehicles only.
- 2.7 An aerial view of the site is attached in **Appendix C**.
- 2.8 Highway boundary plans have been obtained from Hertfordshire County Council, which demonstrate the extent of highway land associated with Long Chaulden, The Avenue and other locations along the eastern site boundary. Copies of these plans are provided in **Appendix D**.
- 2.9 The topography within the site is quite steep in nature. The highest level is approximately 155m AOD at the north side, falling to approximately 100m along the south boundary adjacent to Chaulden Lane. The average gradient from north to south is therefore approximately 1 in 22.

3 Site Inspection of Surrounding Road Network

- 3.1 Various site inspections have been undertaken to assess the current road network in the vicinity of the site. Generally, all the local roads in the vicinity of the site are subject to a 30mph speed limit restriction. However, a section of Chaulden Lane is national speed limit.
- 3.2 Long Chaulden abuts the east side of the site, over a length of about 105m, and is a 6.75m wide local distributor road which links between Warners End Road to the north east and Northridge Way to the south east. This road is subject to camera enforcement measures, implemented by mobile units on a regular basis. These measures are designed to discourage excess speeds along Long Chaulden.
- 3.3 Along the site frontage, wide footways are in place, and no parking restrictions or traffic calming measures exist. Along the sections of road beyond the site frontage, Long Chaulden has verges on both sides which have been paved to allow residents vehicles to be parked off the carriageway. As a consequence, the running carriageway of the road remains clear. 1.8m wide footways are in place behind these verges.
- 3.4 Towards the south east end of Long Chaulden, a school safety zone is in place, which covers the area between Honeycross and Cuttsfield Terrace. Chaulden Infant's and Nursery School and Chaulden Primary School are located to the north east and Pixies Hill Primary School is located to the south. This zone includes 1m wide centre white ladder markings with red surfacing and associated centre refuges, an uncontrolled crossing and double yellow lines.
- 3.5 Various residential roads connect to Long Chaulden along its length via simple tee junctions. These include Green End Lane, Hollybush Lane, Roseheath and Newlands Lane to the north and Middle Hill, Jocketts Road, Honeycross Road, Lindlings, Hazeldell and Pixies Hill Road to the south.
- 3.6 The junction of Long Chaulden and Warners End Road to the north east of the site is a mini roundabout, which also connects with Northridge Way which runs to the south. A short distance westward from this junction, a further mini roundabout is in place, which connects to the southern end of Boxted Road. A controlled pedestrian crossing is located just to the west of this mini roundabout.
- 3.7 The junction of Long Chaulden with Northridge Way to the south east of the site is also a mini roundabout.

- 3.8 Northridge Way runs north to south, effectively connecting between the two ends of Long Chaulden. This is a 6.75m wide road, of a very similar configuration to Long Chaulden, with residents' car parking on hard, off-road verges with footways behind. However, some verges are grassed and some constructed of grasscrete, and several mini roundabouts are in place at junctions as well as tee junctions. There are a series of traffic calming features along this road, including mini roundabouts, central white ladder markings, 1m wide red strips which abut both road channels on the carriageway and white lines adjacent to the channels at some locations.
- 3.9 Towards the south end of Northridge Way, south east of Long Chaulden, a mini roundabout junction with Old Fishery Lane is present, which connects with Chaulden Lane. This road runs to the west, past the site south boundary of the site and connects with Pouchen End Lane further to the west.
- 3.10 The section of Chaulden Lane to the south east of the existing housing has a country lane feel, with hedges and trees immediately adjacent to both sides. The width varies between 4m to 4.8m, and it has been observed that vehicles such as transit vans need to stop and give way to oncoming vehicles. Passing places are present to the west of this section, and forward visibility is poor for drivers in places as they pass existing houses.
- 3.11 The section of Chaulden Lane just to the south west of the existing housing and south east of the development site is more open, with winding alignment and surface set down from the surrounding land to the north. The width is between 4m to 4.3m, and trees hedges are present to the south side. This section of road is subject to the national speed limit.
- 3.12 The western section of Chaulden Lane south of the development site as it approaches Pouchen End Lane becomes markedly more country lane in nature, with significant narrowing, dense shrubbery and trees present, poor visibility and passing places. The road has banks on the north side and is subject to national speed limit.
- 3.13 Pouchen End Lane is a very narrow single track country lane, abutting the western boundary of the site. To the south west, it runs under the railway via a 4.3m wide bridge. It then runs over a canal via a narrow bridge, and joins the A4251 to the south at a tee junction before joining the A41. Vision is poor to the right for emerging drivers at the junction between Pouchen End Lane and the A4251.

- 3.14 At its south end, Northridge Way connects to a conventional 4 arm roundabout, which links to Fishery Road, St Johns Road and Green End Road. Fishery Road leads south to a roundabout on the A4251 London Road at Boxmoor. From this location, traffic can travel east via roundabouts/traffic lights to pick up the A41 or A4146/A414, or travel west via traffic lights to access the B4505 Box Lane and A41.
- 3.15 The Avenue approaches the development site at the north east corner. This is a 6.75m wide access road with wide grass verges and footways to both sides. This road has been designed with no residential frontages, so there is no significant on-road parking observed. There are no parking restrictions or traffic calming measures present, and the road is generally clear.
- 3.16 Inspection of the highway boundary plan based on OS data indicates that the end of The Avenue abuts the site boundary. However, further lines are shown either side of the dotted footway line just to the west. It will be important to compare the OS based land registry plan in order to check that there is no third party ownership between the end of The Avenue and the site.
- 3.17 Various residential cul de sacs connect to The Avenue along its length via simple tee junctions.
- 3.18 The north end of The Avenue connects to Boxted Road at a small 4 arm roundabout, which also caters for Warmark Road, a small residential development. To the north west, Boxted Road leads to Berkhamsted Road which runs to Potten End, Berkhamsted and the A41. To the south east, Boxted Road is 6.75m wide with verges and footways to both sides, and runs to the mini roundabout on Long Chaulden. Cars are observed to park off road on hard verges, so the carriageway is generally clear. Some central ladder markings are present with red surfacing, along with various other calming features such as mini roundabouts and central islands. A controlled pedestrian crossing is in place on Boxted Road to the north of its junction with Long Chaulden.
- 3.19 Warners End Road is a 6.75m wide local distributor road and runs to the east from its junction with Northridge Way, and connects with a large roundabout on Leighton Buzzard Road about 1.1km away.
- 3.20 This road has hard paved verges with footways behind on both sides of the road, and residents' parking is off-road, leaving the carriageway generally clear. No particular traffic calming or parking restrictions appear to be in place along this road, but some 1m wide white ladder markings are in place along part of its length, with a mini roundabout

located at Gadebridge Road. A controlled crossing is located to the west of Gadebridge Road.

- 3.21 The A4146 Leighton Buzzard Road roundabout provides a point where traffic can either run south to the town centre and St Albans, or north to Dunstable, Redbourn or Harpenden. The connection to the east is Queensway, which connects to the north east of Hemel Hempstead, including the industrial areas.
- 3.22 In addition to the roads described above, a residential road network is present along the eastern boundary of the site. This network affords further possibilities for vehicular and pedestrian/cyclist access.
- 3.23 It should be noted that the roads within this area are narrower than the local roads described above, with widths of around 5.0m. In addition, significant on-street residents' parking occurs generally within these areas.
- 3.24 To the south east of the site, a short 5.5m wide spur road runs west from Campion Road and abuts the site boundary. This would appear to have been constructed in order to serve the HCC land parcel. Campion Road connects to Furze Road/Oldfield Road and then to Lindlings, which in turn connects to Long Chaulden via a simple tee junction. This spur road would appear to offer access possibilities for a limited amount of residential development.
- 3.25 Further roads which approach the site on its eastern side are Rowcroft and Ripley Way/Newlands Road to the north; and Musk Hill, and the west end of Lindlings to the south. Inspection of the highway boundary plans confirms that third party land lies between the ends of these roads and the site, and any access for vehicles or pedestrians/cyclists would be subject to negotiation. It has been confirmed by Dacorum Borough Council that the third party land at Rowcroft, Musk Hill, Lindlings and Ripley Way is owned by the Council.
- 3.26 Two sets of bus stops are located on Long Chaulden on either side of the road, to the north and south of the site frontage. To the north, the bus stops are situated about 20m and 80m from the site frontage. To the south, stops are located about 120m and 140m from the site frontage.

4 Existing Public Transport and Other Facilities

Public Transport

- 4.1 There are currently two public transport services running close to the proposed development site. Services 2 and 3 run in opposite directions on a circular route between Woodhall Farm and Chaulden Terrace via the town centre, railway station, Gadebridge, Warners End, Highfield Grove Hill and Cupid Green. The buses run at intervals of 20-30 minutes on weekdays, 30 minutes on Saturdays and hourly on Sundays. These routes go via Long Chaulden and Boxted Road as far as the roundabout at the Boxted Road junction with The Avenue. The centre of the site is approximately 500 metres from the bus stops on Long Chaulden and 800 metres from the turning facility on Boxted Road.
- 4.1.1 In addition there is a morning and evening only peak period only service (H13) between the Maylands Industrial area and the railway station which runs along Long Chaulden every half hour.
- 4.1.2 Along Boxted Road there are further bus services. The 30/31 runs during the morning and evening peak periods between Berkhamsted and Hemel Hempstead town centre whilst the 532 operates three times a day in the off peak period between Hemel Hempstead and Northchurch.

Cycling and Pedestrians

- 4.2 Each of the roads close to the site including Long Chaulden, Boxted Road, Warners End Road, Northridge Way and The Avenue have footways of adequate width along each side.
- 4.3 Along Long Chaulden a controlled crossing is in place just to the west of its mini roundabout junction with Boxted Road. On Long Chaulden to the south east of the site, an uncontrolled crossing is in place, with centre refuge islands.
- 4.4 There are no specific facilities in the immediate area which specifically cater for cyclists such as cycle lanes or controlled crossings.
- 4.5 The centre of the proposed development site is located at the following walking distances from facilities:-

Within 1km of the site;

- i) Secondary School – John F. Kennedy (Catholic School) north east of site.

- ii) Junior School – Chaulden Junior School south east of the site.
- iii) Primary School – Pixies Hill Primary School south east of the site.
- iv) Infant and Nursery School – Chaulden Infant and Nursery School south east of the site.
- v) Recreational – Northridge Park east of the site.
- vi) Recreational – Shrub Hill Common east of the site.
- vii) Recreational – Watercress Beds Playing Fields south east of the site.
- viii) Local Amenities – Post Office, Doctors’ Surgery, Chemist, local shops.
- ix) Several Churches are located within 1km to the site.

Other facilities just beyond 1km of the site include;

- i) Local Amenities – Dentist, Tesco Express, other local shops.
- ii) Primary School – Micklem Primary School east of the site.
- iii) Kindergarten – Play Plus Kindergarten south of the site.
- iv) Recreational – Camelot Rugby Club located south east of the site.

4.6 At present, there would not appear to be any formal Sustrans strategic cycle network routes in the area. However, a formal cycle route, the ‘Nicky Line’, is located approximately 2.3km to the north east of the site, which runs in a north easterly direction towards Harpenden. The route is 8 miles long. There are also informal cycle routes located south of the site along the Grand Union Canal.

4.7 It is recommended that any development sites should incorporate a network of new cycle routes within the development linking to existing bridleways, foot/cycleways and the like. Consideration should also be given to implementation of new foot/cycleways or cycle lanes on roads surrounding the site to link the key facilities and employment areas.

Rail Links

Hemel Hempstead Station is located approximately 1.8 km to the south east of the site from where it abuts Long Chaulden. The station forms part of the London Midlands Train railway network and links London with Watford, Milton Keynes, Northampton and the West Midlands at regular intervals. Current bus services 2, 3 and H13 all stop at the railway station.

5 Personal Injury Accident Records

- 5.1 Over sixty personal injury accidents occurred throughout the Chaulden area in the five year period to March 2006 and the road has been part of the County Council's recent Safety Engineering and Casualty Reduction Programme. A variety of pedestrian crossings, raised tables and a mini roundabout were introduced in 2010 to improve drivers' awareness of the road layout, reduce vehicle speeds and assist pedestrians to cross the road.
- 5.2 The most recent accident data for the area in the vicinity of the site has been obtained from Hertfordshire Highways for the period 1st December 2006 – 30th November 2011. The accident data indicates that a total of 13 PI accidents have occurred in the vicinity of the site. Details are provided in **Appendix E**. This is a considerable improvement over the previous conditions.
- 5.3 The Hertfordshire Highways accident data signifies that no accidents have occurred adjacent to the site boundary where it abuts Long Chaulden.
- 5.4 Two slight PI accidents have occurred to the south of the entrance to the site, located between the junctions of Lucks Hill and Rowcroft onto Long Chaulden. An accident occurred at the immediate junction of Lucks Hill and Long Chaulden where a vehicle carrying three children travelling north along Long Chaulden impacted with a vehicle pulling out of Lucks Hill. The other accident was located approximately 35m north of the junction of Rowcroft and Long Chaulden. The accident was caused when a vehicle emerging on to Long Chaulden from Rowcroft collided with a parked vehicle.
- 5.5 Further southeast from the site entrance, a slight PI accident occurred 8m southeast of the junction of Hazeldell Road and Long Chaulden, outside the Tudor Rose PH. The accident was caused when a vehicle pulled out of the pub car park and impacted with a pedestrian. The pedestrian sustained 'slight' injuries.
- 5.6 Between the junctions of Pixies Hill Road and Cuttsfield Terrace onto Long Chaulden two slight PI accidents have occurred involving cyclists. Approximately 7m southwest of Pixies Hill Road junction an accident occurred when a cyclist travelling along Long Chaulden sustained slight injuries after colliding with the nearside of a vehicle pulling out of Pixies Hill Road. Similarly, at the junction of Cuttsfield Terrace and Long Chaulden, a cyclist was slightly injured after a collision with the offside of a vehicle turning right at the junction onto Long Chaulden.

- 5.7 At the mini roundabout junction of Long Chaulden and Northridge Way, two slight PI injuries have occurred.
- 5.8 A slight PI accident has occurred approximately 8m east of the junction of Long Chaulden and Ravensdell, when a vehicle collided into a reversing vehicle.
- 5.9 In close proximity to the junction of Long Chaulden and the east entrance to Varney Road, accident data indicates that two slight PI accidents have occurred. Approximately 28m west of the junction a 'serious' accident occurred when toddler was injured when exiting a public bus. Approximately 50m east, a further accident has occurred when a vehicle pulling out of a layby on Long Chaulden collided into the rear of a vehicle waiting to turn right onto Hollybush Lane.
- 5.10 An accident has also occurred at the entrance to the car park off Long Chaulden for a shopping precinct located 5m northwest of the junction with Stoneycroft.
- 5.11 At the shopping precinct car park adjacent to Boxted Road, a fatal accident occurred when a vehicle reversed into a pedestrian.
- 5.12 At the mini roundabout junction of Warners End Road, Boxted Road and Long Chaulden a slight PI accident occurred when a car entering the roundabout from Long Chaulden collided with the offside of a vehicle turning right at the roundabout.
- 5.13 It is also noted that a number of slight accidents have occurred further afield, the majority along Northridge Way. A 'serious' accident has also occurred along Boxted Road, north of the junction with Peartree Road.

6 Development Proposals

- 6.1 The site covers an area of approximately 51 hectares and the proposal is for it to become an Urban Extension of residential dwellings and associated uses in line with the Council's emerging Core Strategy, including provision of a primary school, doctors surgery and community uses.
- 6.2 The proposals are at an early stage, and will be progressively determined through a detailed site layout exercise. The site will be developed primarily with residential housing of up to 900 units. In addition, a 2FE primary school and community uses including a doctors surgery would be provided within the development.
- 6.3 At this stage, the composition of the proposed residential part of the site is not known. It may however be assumed that there will be a broadly uniform distribution of houses with 2, 3 and 4 bedrooms on two or three levels of which approximately 40% will be 'affordable homes'. The housing will be located fairly evenly throughout the site, along with significant areas of public open space and structured landscaping.
- 6.4 In order to maximise the sustainability credentials of the site, it is envisaged that the proposed primary school and nursery will be located approximately midway along the eastern site boundary, in the vicinity of Long Chaulden. This will not only locate the school in the optimum position for the potential pupil catchment within the site, but will also position it centrally adjacent to current housing areas to the west.
- 6.5 It is expected that the community facilities will also be located in a similar area.
- 6.6 Within the site, a suitable network of roads will be provided in accordance with the latest edition of the Hertfordshire Design Guide, and be to the appropriate level in the hierarchy. These roads will be arranged to generally discourage general through traffic between Long Chaulden and The Avenue, although a dedicated bus link may be considered to be appropriate.
- 6.7 Operators would be encouraged to provide public transport services into and through the site but measures (such as bus gates) may be put in place to prevent private cars using the two access roads to 'rat run' through the residential area, if rat running is considered to be an issue.
- 6.8 A network of footways and cycle routes will be provided within the site, with appropriate links to the external networks as appropriate, in order to maximise the opportunities for sustainable travel modes wherever practicable. These may include links not only to the

main points of access, but to the residential network to the east of the site. Shared footway/cycleways would also be provided to enable access to the school and the community uses. This should encourage downward pressure on car use where possible.

- 6.9 In order to disperse site generated vehicular traffic, we will consider three points of access to the site, including Long Chaulden, The Avenue and the Campion Road spur road. Appropriate levels of development will be allocated to each, with the shape of the proposed internal road network having an influence on achieving these allocations. Further details of the proposed access options are described in more detail in the next section of the report.

7 Means of Access Proposals

- 7.1 As described above, for the purposes of this appraisal, a minimum of three vehicular accesses will be considered to cater for the development at the site. In addition, other options will be explored, including possible routes which could cater for cyclists and pedestrians only.
- 7.2 Drawing Number ST-2189-23-A has been prepared which gives an overview of the options available, and is attached in **Appendix F**.
- 7.3 It is considered that a loop road of 6.75m width is likely to be required within the site, in order to cater for a suitable bus route in the future. In addition, a further access road is required to serve development in the southern portion of the site. Inspection of the preliminary internal road network and surrounding roads shows that the majority of site traffic is likely to utilise the Chaulden Road access, including traffic from the southern half of the loop, as the external choice of routes and destinations is more convenient to drivers from these areas. This part of the site covers an area of about 34ha. Drivers from the development in the northern half of the loop road are likely to use The Avenue, as this would be a more convenient exit and exit route around this location. This part of the site covers an area of about 15ha. The smaller area to the south, served by Campion Road, would not be connected the rest of the internal site development. The area served here is about 2ha.
- 7.4 It is considered that due to the level of development proposed, there should be a road link through the site, which would facilitate a future bus link, benefit circulation and provide an alternative access in the event of an emergency or potential future roadworks etc.
- 7.5 Consideration has been given to the relative merits of using such potential vehicular accesses as Lindlings, Musk Hill or Rowcroft as opposed to The Campions. It is clear that The Campions is a purpose built spur, with adequate width and associated footways. However, as discussed in this report, we have not ruled out their use as possible development access points. If such access points are used, this would not have a material effect on the overall trip assignment or trip distribution.
- 7.6 The potential distribution of development traffic from the two primary proposed accesses, and the more restricted The Campions access is dealt with in more detail in Section 9 of this report.

7.7 Reference has been made to the Hemel Hempstead Urban Transport Model report; LDF Option Western Hemel, prepared in 2010 by Steer Davies Gleave. This report refers to the likely site access road scenario, and allows for two primary accesses, one at Long Chaulden between Newlands and Middle Hill and one at The Avenue connecting to Boxted Road. This is compatible with the primary access proposals referred to in this report.

i) Long Chaulden

A junction at this location is proposed to be the primary vehicular and pedestrian access which would serve the site. A ghost island right turning facility is proposed, and Drawing ST-2189-1-B has been prepared to demonstrate that this is a feasible option in technical terms. A copy of this drawing is attached in **Appendix F**.

It can be seen from this drawing that the site access road is proposed at 6.75m wide, which is an appropriate standard for a potential bus route, and is compatible with the width of Long Chaulden. Two no. 3.5m running lanes and a 3.0m wide turning lane are proposed on Long Chaulden, achieved by appropriate tapers on both approaches. Vision splays of 4.5m x 90m are provided, which meet required standards.

In the event that a more significant junction is needed, it would be possible to provide a roundabout junction at this location if necessary. However, it should be borne in mind that this would be more intrusive, particularly with respect to lighting, and will take more land.

Appropriate pedestrian and cycle links would also be provided at this location to link with the site. At this stage it is anticipated that a segregated foot/cycleway link will be provided to link directly to the proposed school and community facilities. This should be positioned away from the main vehicular access to allow provision of a signal controlled crossing for school pupils and community users.

ii) The Avenue

It is proposed to continue The Avenue and its associated footways into the site at its current width of 6.75m, as indicated on Drawing ST-2189-24. This would allow sufficient width for buses if these were to be routed along this road.

Appropriate pedestrian and cycle links would also be provided at this location to link with the site.

iii) Campion Road Spur

This spur road is 5.5m wide, and runs west from Campion Road and abuts the HCC site boundary.

It is proposed to utilise this access for vehicles and pedestrians to serve a restricted number of dwellings, bearing in mind the nature of the adjacent residential roads such as Furze Road, Oldfield Road and Lindlings, which are about 5m wide with residential on-street parking.

iv) West of Ripley Way/Newlands Road

A grassed corridor with narrow footways to both sides is in place at this location which would appear to link between the eastern site boundary and Myrtle Green. This land is not highway and would appear to serve numbers 29-47 Newlands Road. Bearing in mind the land is in Dacorum Borough Council ownership, it may be possible to form a foot/cycleway link from the site to Newlands Road/Long Chaulden. However, this may not prove necessary due to the fairly close proximity of The Avenue to the north and Long Chaulden to the south. It is unlikely that a vehicular connection would be necessary at this location, due to the proximity of other site roads, and in any event, the probable felling of a mature Oak tree would be required.

v) Rowcroft

A grassed corridor similar to the above but narrower with narrow footways to both sides is in place at this location which would appear to link between the eastern site boundary and Rowcroft. This land would appear to serve numbers 2-12 and 27-35 Rowcroft. Again, bearing in mind the land is in Dacorum Borough Council ownership, it may be possible to form a foot/cycleway link from the site to Long Chaulden. This may be useful as a more direct connection to the south east towards the south of the town and railway station. A vehicular connection may be possible at this location, but would only be suitable for an extremely low number of dwellings. The link between Rowcroft and Long Chaulden is quite short and direct, but the road is narrow (about 5m) and has residents parking to both sides. However, most residents park on hard verges off-road. Provision of a road would probably necessitate the felling of mature trees.

vi) Musk Hill

This narrow road is about 4m-4.5m wide with narrow footways to both sides, and stops just short of the development site boundary. This road appears to serve numbers 1-10 Musk Hill. It may be possible to form a foot/cycleway link from Footpath 091 in the site to Honeycross Road, which forms a direct connection to Long Chaulden. A vehicular connection could be problematic at this location, due to the narrow road width and on-street parking. Provision of a road would probably necessitate the felling of mature trees.

vii) West end of Lindlings

The west end of Lindlings also approaches the site boundary, and Dacorum Borough Council land lies between. It may be possible to form a foot/cycleway link from the site to Lindlings, which forms a direct connection to Long Chaulden. A vehicular connection would appear to be technically feasible for a limited number of units, but Lindlings is only about 5m wide, with some residents parking is present. It is considered that this possible location is a better prospect than Musk Hill. Revised priorities at the junction between Honeycross Road and Lindlings may need to be considered.

viii) Chaulden Lane

As previously described, Chaulden Lane is “Country Lane” in nature, and is not considered suitable for vehicular access to the site. This road is narrow, has poor visibility and no associated footways where it abuts the site, even to the east of the frontage. It will be necessary to consider whether an emergency vehicular access on to this road is required and this would need to be located along the HCC frontage, where vision may be available. It is difficult to see how a safe means of pedestrian/cycle access to/from the site is possible direct from the southern site frontage. However, a pedestrian route exists which runs from the Campion Road Spur, east along Sundew Road and then south connecting to Chaulden Lane to the east of the southern site frontage. This access point is then a short walk/cycle to an existing off road footway in the playing field to the south east. The south of the town and station is then a short walk away.

It is noted that the small hamlet of Winkwell is situated just to the south west of the site. It would be possible to form an exit from the site to Chaulden Lane, which would enable pedestrians or cyclists to use this road to gain access to the hamlet, Grand Union Canal and the A4251 beyond via Pouchen End Lane and Winkwell Lane. However, there are

no footpaths associated with these roads, and they are very narrow with winding alignments. The possible route is marked on Drawing Number ST-2189-23-B.

ix) Pouchen End Lane

This lane is little more than a farm track, and although it abuts the site on its western boundary, no direct vehicular access will be provided on to this road whatever the final proposals. Public Footpath 91 crosses the site between Musk Hill and Pouchen End Lane, and the connections at each end to the adjacent areas will be retained under the development proposals.

8 Current Traffic Flows on links and junctions within the Study Area

- 8.1 A meeting has been carried out with the Highway Authority in order to determine their requirements in relation to the scope of this report, which will provide supporting information for the forthcoming core strategy submission.
- 8.2 Details of the above are contained in Stomor Ltd's letter dated 22nd March 2012, and includes preliminary residential trip rates to be applied and the junctions to be analysed. A copy of this letter is attached in **Appendix G**.
- 8.3 The junctions to be considered at this stage include the following:-
- a. Junction 1 - Long Chaulden between Newlands Road and Middlehill for the AM and PM peak periods.
 - b. Junction 2 - The Avenue/Boxted Road roundabout for the AM and PM peak periods.
 - c. Junction 3 - Long Chaulden junction with Northridge Way for the AM and PM peak periods.
 - d. Junction 4 - Long Chaulden junction with Boxted Road for the AM and PM peak periods.
 - e. Junction 5 - Warners End Road junction with Northridge Way for the AM and PM peak periods.
 - f. Junction 6 - Leighton Buzzard Road roundabout junction with Warners End Road and Queensway for the AM and PM peak periods.
- 8.4 Classified traffic counts were carried out at these junctions on 27th March 2012. The raw traffic data has been extracted, and flows shown at the various locations on Drawing Numbers ST-2189-16 and 17 are attached in **Appendix H**
- 8.5 Site inspections were also carried out on the day of the traffic counts in the AM peak period, in order to visually assess the level of queuing which takes place at the above junction locations. This exercise was carried out in order to enable us to prepare and validate the Picady/Arcady runs for the various scenarios to be tested. A copy of Drawing Number ST-2189-28 showing the maximum queues observed is attached in **Appendix H**.
- 8.6 Whilst the general road network was observed to be busy in the peak hours, queuing appeared to be fairly light, although southbound queuing at the Leighton Buzzard Road roundabout was observed to build up for brief periods during the AM peak hour.

Observations indicated that this queuing was due to uncertainty and poor lane discipline on the approach, which resulted in left turning vehicles being blocked by straight through movements and right turners. However, this queue was noted to dissipate quite quickly.

- 8.7 Outside of the peak hours traffic flows appeared to fall away significantly, and were easily accommodated on the local road network.
- 8.8 The existing flows along Long Chaulden adjacent to the proposed site primary access point Junction 1 in the AM peak hour are 231 southbound and 205 northbound, giving a two way flow of 436 vehicles. For the PM peak hour, flows are 247 southbound and 233 northbound, giving a two way flow of 480.
- 8.9 The existing flows along The Avenue to the south of the existing roundabout Junction 2 in the AM peak hour are 44 southbound and 225 northbound, giving a two way flow of 269 vehicles. For the PM peak hour, flows are 147 southbound and 60 northbound, giving a two way flow of 207.
- 8.10 In order to initially put the current flows into perspective, TA 79/99 'Traffic Capacity of Urban Roads' has been consulted, which gives an indication of flow capacities for different road categories. Both Long Chaulden and The Avenue are 6.75m wide roads, and are not subject to on-street parking of traffic calming measures. Based on Tables 1 and 2 of this document, we would consider that both of these roads would easily fall into the UAP3 category, and probably perform more in line with a UAP2 road. For a UAP3 road, the maximum suggested flow in one direction would be 1110 vehicles (60%). This would indicate a flow in the opposite direction of 740 vehicles (40%), giving a two way flow of 1850 vehicles. From the above information, it can be seen that the current flows lie well within the environmental capacity of these two roads in the vicinity of the site.
- 8.11 A preliminary Arcady run has been carried out for Junction 2 above under current 2012 AM and PM peak traffic flow conditions. This is based on Stomor Drawing ST-2189-24. This drawing and Arcady results are attached in **Appendix I**. This shows that the maximum Ratio of demand Flow to junction Capacity (RFC) generated is 0.48, which generates a queue of less than 1 vehicle. The maximum Level Of Service (LOS) column shows that this lies in Category A, which indicates Free Flow conditions. The following table gives the definition of the various LOS scenarios as follows:-

A	Free Flow
B	Reasonably Free Flow
C	Stable Flow
D	Approaching Unstable Flow

E	Unstable Flow
F	Forced or Breakdown Flow

- 8.12 Therefore, there are no current issues relating to the area of Long Chaulden in the vicinity of proposed Junction 1, or at the Junction 2 roundabout at The Avenue.
- 8.13 With regard to the road network in the vicinity of Junctions 3 to 5, all the roads are of a similar nature and width. However, the Warners End Approach to Junction 6 is approximately 7.3m width. Inspection of the current traffic flow drawings ST-2189-16 and 17 indicate that the current flows lie within the link capacities.

The below table summarises the current flows at various locations on the local network:-

Existing 2012 Flows

Location	AM Peak Flow	PM Peak Flow	TA 79/99 (UAP3 Road Category)
Long Chaulden adjacent to site access	To South – 231 To North – 205 Total - 436	To South – 247 To North – 233 Total - 480	1100 – (60%) 740 - (40%) Total 1850
The Avenue	To South – 44 To North – 225 Total - 269	To South – 147 To North – 60 Total - 207	1100 – (60%) 740 - (40%) Total 1850
Long Chaulden to east of Junction 5 and west of Junction 5	To East– 843 To West – 497 Total - 1340	To East – 605 To West – 797 Total - 1402	1100 – (60%) 740 - (40%) Total 1850
Warners End Road to east of Junction 5	To East– 716 To West – 434 Total - 1150	To East – 568 To West – 681 Total - 1249	1100 – (60%) 740 - (40%) Total 1850
Warners End Road to west of Junction 6	To East– 931 To West – 651 Total - 1582	To East – 500 To West – 1021 Total - 1521	1300 – (60%) 867 - (40%) Total 2166
North Ridge to south of Junction 3	To South– 701 To North – 467 Total - 1168	To South – 571 To North – 764 Total - 1335	1100 – (60%) 740 - (40%) Total 1850

Development Trip Generation and Distribution

- 9.1 Stomor Ltd have reviewed reports which were carried out to assess various residential development proposals for the Fields End site over the past six years. The latest proposals include a new primary school, doctors surgery and community uses. These facilities clearly increase the sustainability credentials of the site and have a beneficial downward effect on the overall trip generation rates.

Residential Trip Generation

- 9.2 Two way trip rates previously used in the above reports vary from between 0.57 to 0.95 in the AM peak and 0.58 to 1.012 in the PM peak.
- 9.3 Inspection of the TRICS database for private residential houses shows the following results:-

AM 8:00am- :00am			PM 5:00pm-6:00pm		
Arrivals	Departures	Two Way	Arrivals	Departures	Two Way
0 161	0.422	0 583	0.393	0.236	0 62

- 9.4 It should be noted that it is expected that 40% of the housing will be affordable homes. This is likely to have the effect of downward pressure on the trip rates for the development.
- 9.5 In consideration of the above, an assessment of the likely generation and distribution of the traffic associated with the new developments has been carried out. Trip generation for the residential development has been determined by the above TRICS database results and inspection of rates used in previous studies. The following trip rates are as described in the Stomor letter to the Highway Authority on 22nd March 2012:-

AM 8:00am- :00am			PM 5:00pm-6:00pm		
Arrivals	Departures	Two Way	Arrivals	Departures	Two Way
0.2	0.5	0 7	0.4	0.25	0 65

- 9.6 These trip rates are in excess of the TRICS database values, and are considered robust and reasonable given the facilities provided on the site. The Highway Authority have confirmed that the trip rates proposed are acceptable, and a copy of their email confirming this is attached in **Appendix G**.

9.7 Based on 900 residential dwellings, the following numbers of vehicles are generated as follows:-

AM 8:00am- :00am			PM 5:00pm-6:00pm		
Arrivals	Departures	Two Way	Arrivals	Departures	Two Way
180	450	630	360	225	585

School Trip Generation

9.8 Trip generation in the AM peak hour of the 2FE primary school is based on a school roll of 420 pupils and 30 in the nursery, giving a total of 450 pupils.

9.9 Using data obtained from studies of other schools in Hemel Hempstead such as Tudor Primary and Hammond Primary, the following table shows the approximate distribution of pupils for different distance bands:-

Distance Band	% of pupils	Number of Pupils
0km – 0.5km	48	216
0.5km – 1km	28	126
1km – 2km	15	68
Over 2km	9	40
Total	100	450

9.10 Overall, this would generate the following pupil related cars in the AM peak hour as follows:-

Distance Band	Car generation	No of Pupils	% by car	Number of cars
0km – 0.5km	0% - 5%	216	2	4
0.5km – 1km	10% – 15%	126	10	13
1km – 2km	50% - 60%	68	55	37
Over 2km	90% - 100%	40	95	38
Total		450		92

9.11 The above table indicates that the pupil car trip generation equates to about 20% of the pupil roll, which is reasonable bearing in mind the accessibility and tight catchment associated with the school.

9.12 Drawing Number ST-2189-11-A has been prepared, which shows the above distance bands relating to the school site and the likely percentage assignment of cars to the

school in the AM peak period, and is attached in **Appendix J**. It can be seen that within each distance band, percentages of school car trips made by pupils is assigned to the internal estate roads or primary accesses either at Long Chaulden or The Avenue. The sum of the percentages in each distance band equates to 100%. For example, in distance band 0.5km-1km, of the 13 vehicles total, 10% is assigned to The Avenue 85% assigned to Long Chaulden and 5% assigned from internal site roads to the south of the site.

- 9.13 With respect to school staff, it is anticipated that 42 would arrive at the site in the AM peak hour, of which about 34 would arrive by car, based upon observations at other schools.

Other Trip Generation

- 9.14 Trip generation related to the local facilities is expected to be very low in the AM and PM peak hours. Based on a trip rate of 10% of 900 units with 20% travelling by car, this gives a flow of about 18 vehicles inwards. Departures are estimated to be about 5 vehicles.

Traffic Distribution

- 9.15 The distribution of site generated residential traffic has been allocated to the three points of access serving the site which have been described in previous sections of this report. It is considered that a significant proportion of housing development to the north and centre of the site would utilise the access provided on Long Chaulden, with traffic to the north of the site tending to use The Avenue. Due to the nature of the residential roads around Champion Road, it is envisaged that only a limited number of units should be proposed off the spur road at this location. At this stage, we propose the following for the purposes of assessment, based upon the areas of development associated with each of the three proposed access points and the likely easiest routes for drivers:-

Access Point	% allocated	Associated Area (ha)	Number of Units
The Avenue	28.7	14.5	258
Long Chaulden	66.9	33.8	602
Champion Road Spur	4.4	2.2	40
Total	100	50.5	900

- 9.16 At this stage, this scenario is considered reasonable for a robust assessment to be carried out for site allocation purposes, and will be refined as more detailed development proposals emerge in due course.
- 9.17 With regard to the 2FE primary school, as this is likely to be located in the vicinity of the Long Chaulden access, it is envisaged that the majority of vehicles will use this access point. However, some vehicles will arrive via The Avenue from the north of the site.
- 9.18 The community uses will be provided to serve the local area, and for this assessment, we have assumed 100% of associated traffic would utilise Long Chaulden.
- 9.19 Data has been obtained from the Office for National Statistics; Neighbourhood Statistics, for distances travelled to work by local people in the Chaulden and Warners End Wards of Hemel Hempstead. This data has been used as a basis for the likely distribution of residential traffic generated by the development around the local road network.
- 9.20 The following table gives the Census data based on the above:-

Distance travelled to/from work	Percentage %	Number of people
Less than 2km	17.5	390
2km – 5 km	37.2	827
Over 5km	45.3	1008
Total	100	2225

- 9.21 It is clear that people who live closer to their place of work, particularly within the 0-2km band, will have the best opportunity to use other forms of transport rather than the private car. Therefore, based upon the likely distances travelled to work, the following table shows the predicted number of cars generated from the site travelling within each distance band:-

Distance band	Number of people in census	% likely to drive	Number likely to drive	%	x450 (site related)
Less than 2km	390	60	234	13	59
2km – 5 km	827	80	661	36	162
Over 5km	1008	95	958	51	229
Total	2225			100	450

- 9.22 In the less than 2km band, residential traffic from the Long Chaulden access is allocated 50/50 to the north and south, which allows for traffic either travelling north to Mylands and Buncefield industrial area or south to the rail station and town centre. There may be possible losses prior to traffic reaching Leighton Buzzard roundabout due to general distribution, rat runs, destinations etc. At the junction with The Avenue/Boxted Road, residential traffic is distributed 10% westward and 90% eastward.
- 9.23 In the 2km – 5km band, it is assumed that 60% travel to the north side of town towards major employment areas and to avoid the Plough Roundabout. Few are assumed to travel by train within this band. At the junction with The Avenue/Boxted Road, residential traffic is distributed 15% westward and 85% eastward.
- 9.24 It is considered that residential traffic accessing strategic routes over 5km from the site would be well distributed in all directions. These routes would include the A4146, B487 and A4147 travelling north to Leighton Buzzard, Harpenden, Luton and Dunstable, and the M1, A41 and M25 to the south. The A414 and M1 Junction 7/8 are located to the east which connect with St Albans and Hatfield, and the A41 runs west towards Berkhamsted, Tring and Aylesbury. In the light of this, residential traffic in this band is allocated 50/50 to the north and south from Long Chaulden. At the junction with The Avenue/Boxted Road, residential traffic is distributed 20% westward and 80% eastward. It is assumed that approximately 5% will travel by bus or rail, with additional rail commuters driving to the station.
- 9.25 For the purposes of this assessment, incoming residential vehicles are assigned in similar proportions to outgoing traffic.
- 9.26 The above distribution of future residential traffic is proposed in order to enable a robust assessment of the likely performance of primary junctions located around the site, and to demonstrate that they will be capable of catering for future traffic either with or without improvements. It is fully appreciated that as traffic flows increase in the future, it is possible that some drivers will modify their routes to utilise less congested roads if possible.
- 9.27 Routes such as Galley Hill connect Boxted Road with Leighton Buzzard Road further to the north, and may attract some vehicles from The Avenue and possibly Long Chaulden. The assessment has been carried out to test key junctions such as the double mini roundabouts at Boxted Road and Northridge Way and the Warners End/Leighton Buzzard roundabout. Use of the Galley Hill route may effect a modest traffic reduction at the above junctions. However, this report tests a scenario to demonstrate that the

- above junctions could cater for the full potential flows in the future, even if drivers do not choose alternative routes.
- 9.28 Green End Lane or Hollybush Lane may also be considered as alternative routes by motorists. However, based upon the above discussion, we have accounted for this traffic within the key junctions in order to ensure a robust assessment.
- 9.29 In relation to the primary school distribution, the OS plans for the local area have been inspected, and incoming traffic assigned along the likely routes from each distance band as described above. Drawing Number ST-2189-11 has been prepared, which is attached in **Appendix J**. The parent related vehicles are assumed to exit the school along similar routes as incoming, and staff are assumed to remain.
- 9.30 Based upon all the above parameters, Drawing Numbers ST-2189-12, 13, and 14 have been prepared, which show the proposed housing development flows, proposed school and community uses flows, and total AM development flows respectively. These are also attached in **Appendix J**.
- 9.31 With respect to the PM peak scenario, the appropriate trip generation rates have been applied for the 900 residential units as described in previous sections of this report. For the purposes of this report, the resulting traffic has been assigned in similar proportions to the AM traffic. The relatively light community use traffic expected in the AM peak as described previously will be added to the PM peak development flows
- 9.32 Drawing ST-2189-15 has been prepared showing these traffic flows, and is attached in **Appendix** .
- 9.33 As the school will close at around 3:15 PM, traffic associated with this use is not included in the 5:00-6:00 PM peak assessment.
- 9.34 Overall, it is considered that the proposed assignment and distribution of future traffic described in this report represents a robust basis for junction appraisal, to demonstrate that the proposed development of up to 900 houses and a school are deliverable and suitable for allocation, subject to future more detailed transport assessment as the actual development proposals emerge.

10 Assessment Years and Growth

- 10.1 The growth in background traffic is commonly estimated by the application of the National Road Traffic Forecasts (NRTF), adjusted locally by the Trip End Model presentation PROgram (TEMPRO) database. Hertfordshire County Council has its own local forecasts which are available in the latest Hertfordshire Traffic and Transport Data Report (2009) published in August 2010.
- 10.2 Using 2012 as the base year the forecasts in the report show an increase in traffic in Dacorum of 8.56% by 2021. Using Temprom 6.2, Eastern Region, the increase in traffic is identified as 8.42%, which is reasonably comparable. The HCC data report does not go beyond 2021, so Temprom 6.2 has been referred to for 2031, giving an estimated increase of 16.4% by 2031.
- 10.3 It is considered that the introduction of the proposed Fields End Development on an ongoing basis up to Year 2031 would represent the likely growth in flows along Long Chaulden, The Avenue and Lindlings. However, developments elsewhere in Hemel Hempstead and further afield would be likely to form a significant part of Temprom growth up to Year 2031 as described above. We have therefore added the full Temprom growth rates to existing flows along Boxted Road, Long Chaulden to the east of Junction 4, Warners End Road, Northridge Way and the roundabout junction between Warners End Road, Queensway and Leighton Buzzard Road. This scenario is therefore considered to be robust as we have assumed continuous full growth up to Year 2031. It should be borne in mind that the actual growth which would actually occur over such an extended timescale is by no means certain and could be more or less than presently anticipated.
- 10.4 During several visits to the site and surrounding area, it was noted that traffic seemed to flow reasonably freely in the AM and PM peak hours in the immediate vicinity of the envisaged site accesses. However, it was observed that general network became quite busy slightly further afield in the AM peak period, and it was noted that as shown on Drawing Number ST-2189-28, queues formed on the southbound approaches to Junction 4 (11 vehicles) and Junction 6 (occasionally 40-50 vehicles), and on the eastbound approach to Junction 6 (12 vehicles).
- 10.5 These observed queues ebbed and flowed, and would sometimes disappear altogether for brief periods before building up again.

11 Discussion on Implications to the Wider Road Network

- 11.1 Reference has been made to the Hemel Hempstead Urban Transport Model report; LDF Option Western Hemel, prepared in 2010 by Steer Davies Gleave. This report refers to development of the Fields End site at levels of 450 dwellings by Year 2021, and 900 dwellings by Year 2031. It also refers to the Marchmont Farm development with 380 dwellings by Year 2021.
- 11.2 The conclusions of this report included the following:-
- Generally, the traffic impacts of the Western Hemel developments on the wider road network would be minimal in Year 2021 in both the AM and PM peak hours. However, some minor localised queuing is expected on the Boxted Road area around Junctions 4 and 5.
 - In Year 2031, development traffic had a more significant effect on the wider network, causing lower network speeds.
 - The localised queuing problems around Boxted Road were magnified in Year 2031, but still not a serious issue.
 - No significant problems are envisaged in the Year 2031 in the PM peak.
 - In the Year 2031 AM peak, serious queuing was identified at the Leighton Buzzard Road roundabout, Junction 6, in the AM peak.
- 11.3 A sensitivity test was carried out as part of the report, which included for half the proposed increase in housing at the Fields End site between Year 2021 and 2031, a total of 675 units. Flow breakdown did not occur under this scenario.
- 11.4 The report gives an indication of potential traffic problems that could occur, and does not include the effects of any junction or network improvements to mitigate the effects of the development.
- 11.5 In order to carry out a preliminary assessment of adjacent road capacities and possible improvement options related to the effects of developing the site, it is necessary to consider the following parameters and issues:-
- i) Considerations such as junction type, road type, widths, vision, parking, traffic calming etc.
 - ii) Level of traffic currently using the adjoining roads, future growth and level of development of the sites in terms of dwelling numbers etc.
- 11.6 Section 9 above has described the trip generation envisaged as a result of the development proposals, and growth to Year 2031 has been estimated in Section 10.

Further traffic flow diagram drawings have been prepared, numbers ST-2189-18, 19, 20 and 21. These show AM and PM peak flows for the existing year 2012 + growth to 2031; and AM and PM peak flows for the existing year 2012 + growth to 2031 + development. These traffic flows are considered to be a reasonable and robust assessment of likely future traffic flows which could occur on the network. The drawings are attached in **Appendix** .

- 11.7 In link capacity terms, inspection of the growth plus potential development generated flows in Year 2031 gives an indication of whether the level of development will start to impose capacity problems on the adjacent road network.
- 11.8 The following table summarises the post development flows at Year 2031 at various locations on the local network:-

Year 2031 Post Development Flows

Location	AM Peak Flow	PM Peak Flow	TA 79/99 (UAP3 Road Category)
Long Chaulden adjacent to site access	To South – 399 To North – 402 Total - 801	To South – 378 To North – 347 Total - 725	1100 – (60%) 740 - (40%) Total 1850
The Avenue	To South – 103 To North – 359 Total - 462	To South – 250 To North – 124 Total - 374	1100 – (60%) 740 - (40%) Total 1850
Long Chaulden to east of Junction 4 and west of Junction 5	To East– 1251 To West – 732 Total - 1983	To East – 1146 To West – 844 Total - 1990	1100 – (60%) 740 - (40%) Total 1850
Warners End Road to east of Junction 5	To East– 1111 To West – 652 Total - 1763	To East – 790 To West – 1011 Total - 1801	1100 – (60%) 740 - (40%) Total 1850
Warners End Road to west of Junction 6	To East– 1318 To West – 879 Total - 2197	To East – 692 To West – 1292 Total - 1984	1300 – (60%) 867 - (40%) Total 2166
North Ridge to south of Junction 3	To South–943 To North – 611 Total - 1554	To South – 706 To North – 952 Total - 1658	1100 – (60%) 740 - (40%) Total 1850

- 11.9 It can be seen from the table above that the majority of the local road flows still lie within the TA 79/99 ‘Traffic Capacity of Urban Roads’ parameters for category UAP3 roads at Year 2031 with growth and development. However, it is identified that these values are exceeded around junctions 4/5 in the AM and PM peaks, and to the west of Junction 6 in

the AM peak. As previously described in the report, the general road network in the vicinity is generally clear and open, without significant parking or traffic calming, so their capacity would probably be more in line with the higher UAP2 category, which would be adequate to cater for the future flows from a link capacity point of view.

11.10 As previously indicated, six junctions are to be investigated in connection with the proposed development, as discussed with the Highway Authority, in order to assess the current scenario and the longer term effects brought about by growth and the proposed development.

Junction 1

11.11 It is proposed that Junction 1 will take the form of a new right turn lane facility, as previously described in Section 7 of this report and shown on Drawing ST-2189-1-A.

11.12 In order to test if this junction will be adequate to serve the major part of the development as described earlier in this report, Picady runs for both the AM and PM peak periods have been carried out using the 2031 post development flows as shown on Drawing Numbers ST-2189-20 and 21.

11.13 The results of these runs show that the junction works well within capacity with maximum RFC values of 0.413 and 0.24 in the AM and PM peak hours respectively, with negligible queuing. Copies of the Picady runs are attached in **Appendix L**. The junction is therefore considered suitable to serve the proposed development.

Junction 2

11.14 As described in Section 8 above, an Arcady run has been carried out under current Year 2012 traffic flow conditions, which shows that there is more than adequate capacity available and negligible queuing.

11.15 In order to test if this junction will be adequate to serve the significant part of the development as described earlier in this report, Arcady runs for both the AM and PM peak periods have been carried out using the 2031 post development flows as shown on Drawing Numbers ST-2189-20 and 21.

11.16 The results of these runs show that the junction works well within capacity with maximum RFC values of 0.53 and 0.62 in the AM and PM peak hours respectively, with negligible queuing. Copies of the Arcady runs are attached in **Appendix M**. The

junction is therefore considered suitable to serve the proposed development without modification.

Junction 3

11.17 Arcady runs have been carried out under current Year 2012 traffic flow conditions, for both the AM and PM peak periods. A summary table of the AM and PM results is shown below:-

	AM 0800 - 0900			
	Queue (Veh)	Delay (min)	RFC	LOS
(Default Analysis Set) - Existing 2012				
Northridge Way south	1.29	0.15	0.57	A
Long Chaulden	1.30	0.23	0.56	B
Northridge Way north	6.94	0.79	0.89	E

	PM 1700 - 1800			
	Queue (Veh)	Delay (min)	RFC	LOS
(Default Analysis Set) - Existing 2012				
Northridge Way south	9.68	0.74	0.93	E
Long Chaulden	0.91	0.22	0.48	B
Northridge Way north	2.46	0.32	0.71	C

11.18 It can be seen from these runs that there is some queuing currently taking place at this junction; on Northridge Way north in the AM peak and Northridge Way south in the PM peak. RFC values slightly exceed the recommended 0.85, with queue lengths of 7 vehicles and 10 vehicles respectively.

11.19 If growth up to Year 2031 is added to the current Year 2012 flows, with no development, the following results are generated:-

	AM 0800 - 0900			
	Queue (Veh)	Delay (min)	RFC	LOS
(Default Analysis Set) - Year 2031 with growth				
Northridge Way south	1.67	0.18	0.63	B
Long Chaulden	1.48	0.26	0.60	C
Northridge Way north	23.28	2.11	1.03	F

	PM 1700 - 1800			
	Queue (Veh)	Delay (min)	RFC	LOS
(Default Analysis Set) - Year 2031+growth				
Northridge Way south	25.63	1.65	1.02	F
Long Chaulden	1.05	0.26	0.51	C
Northridge Way north	4.28	0.50	0.82	D

11.20 The above results indicate that growth only without development up to Year 2031 will increase potential queuing to the levels shown above. These queuing levels are unlikely to trigger improvements at this junction.

11.21 If the proposed Fields End Development is added to the above, the following results are generated:-

	AM 0800 - 0900			
	Queue (Veh)	Delay (min)	RFC	LOS
	(Default Analysis Set) - Year 2031 with growth + Development			
Northridge Way south	2.77	0.25	0.74	C
Long Chaulden	10.31	1.21	0.95	F
Northridge Way north	74.88	7.18	1.25	F

	PM 1700 - 1800			
	Queue (Veh)	Delay (min)	RFC	LOS
	(Default Analysis Set) - Year 2031 with growth + Development			
Northridge Way south	84.12	5.43	1.16	F
Long Chaulden	1.81	0.33	0.65	C
Northridge Way north	7.24	0.85	0.90	F

11.22 The above results show that significant increase in queuing is likely to occur in both the AM and PM peak periods at Year 2031 as a result of the proposed development, and improvements will be necessary in order to mitigate these effects back to the “do nothing” scenario, assuming no development at Fields End.

11.23 Drawing Number ST-2189-25 has been prepared, showing possible improvements to Junction 3 within the highway in order to mitigate the effects of the proposed development. A copy of this Drawing is attached in **Appendix N**.

11.24 The Arcady runs for both the AM and PM peak periods have been re-run for Year 2031 plus development, including the amended geometric parameters relating to the proposed improvement. The following results are generated as shown below:-

	AM 0800 - 0900			
	Queue (Veh)	Delay (min)	RFC	LOS
	(Default Analysis Set) - Year 2031 with growth + Dev + Improvements			
Northridge Way south	1.32	0.12	0.57	A
Long Chaulden	10.37	1.21	0.95	F
Northridge Way north	6.94	0.67	0.89	E

	PM 1700 - 1800			
	Queue (Veh)	Delay (min)	RFC	LOS
	(Default Analysis Set) - Year 2031 with growth + Dev + Improvements			
Northridge Way south	7.22	0.44	0.89	D
Long Chaulden	2.35	0.43	0.71	D
Northridge Way north	1.93	0.21	0.66	B

11.25 It can be seen from these results that the proposed improvements reduce the major queue lengths on Northridge north in the AM peak and Northridge south in the PM peak back to significantly below the Year 2031 growth only levels, and well below the “growth plus development” levels. There would be a queue increase of approximately 8 vehicles on Long Chaulden in the AM peak period, but this is not considered to cause undue issues. It is therefore considered that the proposed improvements would serve to mitigate the effects of the proposed development.

Junction 4

11.26 Arcady runs have been carried out under current Year 2012 traffic flow conditions, for both the AM and PM peak periods. A summary table of the AM and PM results is shown below:-

	AM 0800 - 0900			
	Queue (Veh)	Delay (min)	RFC	LOS
	(Default Analysis Set) - Existing 2012			
Long Chaulden West	1.20	0.17	0.55	B
Boxted Road	19.47	1.95	0.99	F
Long Chaulden East	1.52	0.18	0.60	B

	PM 1700 - 1800			
	Queue (Veh)	Delay (min)	RFC	LOS
	(Default Analysis Set) - Existing 2012			
Long Chaulden West	1.10	0.19	0.52	B
Boxted Road	2.10	0.27	0.67	C
Long Chaulden East	22.87	1.78	0.99	F

11.27 It can be seen from these runs that there is queuing currently taking place at this junction; on Boxted Road in the AM peak and Long Chaulden East in the PM peak. RFC values exceed the recommended 0.85, with queue lengths of 19 vehicles and 23 vehicles respectively.

11.28 If growth up to Year 2031 is added to the current Year 2012 flows, with no development, the following results are generated:-

	AM 0800 - 0900			
	Queue (Veh)	Delay (min)	RFC	LOS
(Default Analysis Set) - Year 2031 + growth				
Long Chaulden West	1.30	0.19	0.57	B
Boxted Road	86.08	8.12	1.13	F
Long Chaulden East	1.87	0.21	0.65	B

	PM 1700 - 1800			
	Queue (Veh)	Delay (min)	RFC	LOS
(Default Analysis Set) - Year 2031 + growth				
Long Chaulden West	1.19	0.21	0.55	B
Boxted Road	3.12	0.37	0.76	C
Long Chaulden East	89.90	6.25	1.07	F

11.29 The above results clearly indicate that growth only without development up to Year 2031 significantly increases potential queuing to the levels shown above. These queuing levels are likely to put pressure on the Highway Authority to undertake improvements at this junction even if the Fields End development does not proceed.

11.30 However, if development is progressed at Fields End, the potential queuing will further increase very significantly, and it is likely that junction improvements will be required in order to achieve a level of queuing to at least the level of the “do nothing” scenario, to mitigate the effects of the Fields End development.

11.31 Drawing Number ST-2189-26 has been prepared, showing possible improvements to Junctions 4 and 5 within the highway in order to mitigate the effects of the proposed development. A copy of this Drawing is attached in **Appendix O**.

11.32 The Arcady runs for both the AM and PM peak periods have been re-run for Year 2031 plus development, including the amended geometric parameters relating to the proposed improvement. The following results are generated as shown below:-

	AM 0800 - 0900			
	Queue (Veh)	Delay (min)	RFC	LOS
(Default Analysis Set) - Year 2031 with growth + Dev + Improvements				

Long Chaulden West	2.92	0.29	0.75	C
Boxted Road	20.32	1.54	0.98	F
Long Chaulden East	1.53	0.13	0.60	A

PM 1700 - 1800				
	Queue (Veh)	Delay (min)	RFC	LOS
(Default Analysis Set) - Year 2031 + growth + Dev + Improvements				
Long Chaulden West	1.86	0.26	0.65	C
Boxted Road	1.44	0.15	0.58	A
Long Chaulden East	18.53	1.06	0.97	F

11.33 It can be seen from these results that the proposed improvements would appear to significantly reduce queue lengths back to below the Year 2031 growth only levels, and serve to mitigate the effects of the proposed development. However, these results must be taken in the context of the adjacent Junction 5.

Junction 5

11.34 Arcady runs have been carried out under current Year 2012 traffic flow conditions, for both the AM and PM peak periods. Initially, queue lengths in Long Chaulden and Northridge Way generated by these runs appeared to be very high, which was not borne out by on site observations. Therefore, a correction has been made to the slope/intercept value on these arms, in order to generate queues which more reasonably reflect the actual current Year 2012 scenario. A summary table of the AM and PM results is shown below:-

AM 0800 - 0900				
	Queue (Veh)	Delay (min)	RFC	LOS
(Default Analysis Set) - Existing 2012				
Warners End Road	1.95	0.27	0.66	C
Northridge Way	3.68	0.49	0.79	D
Long Chaulden	3.50	0.25	0.78	C

PM 1700 - 1800				
	Queue (Veh)	Delay (min)	RFC	LOS
(Default Analysis Set) - Existing 2012				
Warners End Road	11.47	1.06	0.94	F
Northridge Way	6.01	0.70	0.87	E
Long Chaulden	9.08	0.94	0.92	F

11.35 It can be seen from these runs that there is moderate queuing currently taking place at this junction in the PM peak on all arms. RFC values exceed the recommended 0.85, with queue lengths of up to 11 vehicles.

11.36 If growth up to Year 2031 is added to the current Year 2012 flows, with no development, the following results are generated:-

AM 0800 - 0900				
	Queue (Veh)	Delay (min)	RFC	LOS
(Default Analysis Set) - Year 2031 with growth				
Warners End Road	4.09	0.50	0.81	D
Northridge Way	13.46	1.57	0.96	F
Long Chaulden	10.38	0.66	0.92	E

PM 1700 - 1800				
	Queue (Veh)	Delay (min)	RFC	LOS
(Default Analysis Set) - Year 2031 with growth				
Warners End Road	106.01	8.14	1.11	F
Northridge Way	32.47	3.09	1.04	F
Long Chaulden	71.72	6.32	1.08	F

11.37 The above results clearly indicate that growth only without development up to Year 2031 significantly increases potential queuing in the PM peak to the levels shown above. These queuing levels are likely to put pressure on the Highway Authority to undertake improvements at this junction even if the Fields End development does not proceed.

11.38 However, if development is progressed at Fields End, the potential queuing will further increase very significantly, and it is likely that junction improvements will be required in order to achieve a level of queuing to at least the level of the “do nothing” scenario, to mitigate the effects of the Fields End development.

11.39 Drawing Number ST-2189-26 has been prepared, showing possible improvements to Junctions 4 and 5 within the highway in order to mitigate the effects of the proposed development. A copy of this Drawing is attached in **Appendix O**.

11.40 The Arcady runs for both the AM and PM peak periods have been re-run for Year 2031 plus development, including the amended geometric parameters relating to the proposed improvement. The following results are generated as shown below:-

AM 0800 - 0900				
	Queue (Veh)	Delay (min)	RFC	LOS
(Default Analysis Set) - Year 2031 with growth +Dev +				

	Improvements			
Warners End Road	21.42	2.03	0.99	F
Northridge Way	35.29	4.10	1.05	F
Long Chaulden	6.72	0.33	0.87	C

	PM 1700 - 1800			
	Queue (Veh)	Delay (min)	RFC	LOS
	(Default Analysis Set) - Year 2031 with growth + Dev + Improvements.			
Warners End Road	296.17	20.03	1.26	F
Northridge Way	93.09	9.65	1.15	F
Long Chaulden	4.00	0.28	0.80	C

11.41 It can be seen from the results above that the continuation of a double mini roundabout junction at this location which comprises Junctions 4/5 is unlikely to be appropriate for the Year 2031 scenario, even if the Fields End development did not proceed.

11.42 Under this scenario, it is recommended that a traffic signal control junction should be considered by the Highway Authority, possibly in conjunction with the developer in due course.

11.43 A preliminary feasibility assessment has been carried out for signalisation of Junctions 4 and 5, using the Linsig capacity programme. It would appear that a workable solution could be achieved to cater for the post development flows in Year 2031, but further investigation work will be required in due course. This would include an origin/destination survey of traffic and a full topographical survey of the area in the vicinity of Junctions 4 and 5. A copy of the feasibility Linsig report is attached in **Appendix O**, along with Drawing ST-2189-29 showing a preliminary traffic light layout.

Junction 6

11.44 Arcady runs have been carried out under current Year 2012 traffic flow conditions, for both the AM and PM peak periods. A summary table of the AM and PM results is shown below:-

	AM 0800 - 0900			
	Queue (Veh)	Delay (min)	RFC	LOS
(Default Analysis Set) - Existing 2012				
Warners End Road	6.14	0.38	0.87	C
Leighton Buzzard Road North	2.73	0.16	0.74	A
Queensway	2.09	0.17	0.67	B
Leighton Buzzard Road South	1.26	0.09	0.56	A

	PM 1700 - 1800			
	Queue (Veh)	Delay (min)	RFC	LOS
(Default Analysis Set) - Existing 2012				
Warners End Road	1.11	0.13	0.54	A
Leighton Buzzard Road North	0.74	0.06	0.42	A
Queensway	35.41	1.56	1.03	F
Leighton Buzzard Road South	6.34	0.36	0.88	C

11.45 It can be seen from these runs that there is slight queuing currently taking place at this junction in the AM peak on Warners End Road. The recommended RFC value of 0.85 is slightly exceeded, with a queue length of 6 vehicles.

11.46 In the PM peak, moderate queuing takes place on Queensway, and to a lesser extent on Leighton Buzzard Road South. RFC values exceed the recommended 0.85, with queue lengths of 35 vehicles and 6 vehicles respectively.

11.47 If growth up to Year 2031 is added to the current Year 2012 flows, with no development, the following results are generated:-

	AM 0800 - 0900			
	Queue (Veh)	Delay (min)	RFC	LOS
(Default Analysis Set) - Year 2031 with growth				
Warners End Road	56.71	2.62	1.09	F
Leighton Buzzard Road North	8.58	0.45	0.91	D
Queensway	5.24	0.39	0.85	C
Leighton Buzzard Road South	2.15	0.13	0.69	A

	PM 1700 - 1800			
	Queue (Veh)	Delay (min)	RFC	LOS
	(Default Analysis Set) - Year 2031 with growth			
Warners End Road	1.87	0.18	0.66	B
Leighton Buzzard Road North	1.07	0.07	0.51	A
Queensway	172.19	7.32	1.27	F
Leighton Buzzard Road South	27.68	1.27	1.01	F

11.48 The above results clearly indicate that growth only without development up to Year 2031 significantly increases potential queuing to the levels shown above. These queuing levels are again likely to put pressure on the Highway Authority to undertake improvements at this junction even if the Fields End development does not proceed.

11.49 However, if development is progressed at Fields End, the potential queuing will further increase very significantly, and it is likely that junction improvements will be required in order to achieve a level of queuing to at least the level of the “do nothing” scenario, to mitigate the effects of the Fields End development.

11.50 Drawing Number ST-2189-27-A has been prepared, showing possible improvements to Junction 6 in order to mitigate the effects of the proposed development. A copy of this Drawing is attached in **Appendix P**.

11.51 The Arcady runs for both the AM and PM peak periods have been re-run for Year 2031 plus development, including the amended geometric parameters relating to the proposed roundabout improvement. The following results are generated as shown below:-

	AM 0800 - 0900			
	Queue (Veh)	Delay (min)	RFC	LOS
	(Default Analysis Set) - Year 2031 + growth + development + Improvements			
Warners End Road	36.59	1.46	1.03	F
Leighton Buzzard Road North	27.77	1.31	1.02	F
Queensway	2.92	0.19	0.74	B
Leighton Buzzard Road South	1.66	0.09	0.63	A

	PM 1700 - 1800			
	Queue (Veh)	Delay (min)	RFC	LOS
(Default Analysis Set) - Year 2031 + growth + development + Improvements				
Warners End Road	1.51	0.12	0.61	A
Leighton Buzzard Road North	1.09	0.07	0.52	A
Queensway	75.07	2.49	1.09	F
Leighton Buzzard Road South	39.59	1.60	1.04	F

11.52 It can be seen from these results that the proposed improvements significantly reduce the major queue lengths on Warners End Road in the AM peak and Queensway in the PM peak back to significantly below the Year 2031 growth only levels; minus 20 vehicles and minus 97 vehicles respectively. However, it is noted that a queue increase of 19 vehicles is generated in the AM peak on Leighton Buzzard Road north and 12 vehicles on Leighton Buzzard Road South in the PM peak.

11.53 The roundabout would probably perform reasonably well in the AM peak with the proposed modifications, which would be subject to a topographical survey and detailed design.

11.54 However, potential queuing of 75 vehicles in the PM peak hour at Year 2013 with development and improvements may need to be considered in future in conjunction with the Highway Authority.

11.55 Signalisation of this roundabout may possibly be considered by the Highway Authority to increase capacity prior to 2031, depending on the general growth in traffic over the next few years. Depending on the services in the vicinity of the roundabout, it may be more economical to signalise the junction in any event, to minimise costs and further improve the junction capacity.

12 Conclusions

- 12.1 Stomor Ltd has been commissioned by Taylor Wimpey Strategic Land, to prepare a Means of Access, Transport and Sustainability Appraisal for land at Fields End, Hemel Hempstead, Herts.
- 12.2 This report covers investigations associated with potential new residential and associated development at the site, including assessment of access arrangements available to serve the site from the surrounding road network.
- 12.3 Site visits were undertaken to inspect the sites and surrounding road network, in order to assess accessibility and traffic implications of the proposed developments on the site.
- 12.4 Various classified traffic counts were carried out in order to assess the current traffic flow situation on the road network, and likely effects of potential development.
- 12.5 The site covers an area of approximately 51 hectares and the proposal is for it to become an Urban Extension of residential dwellings and associated uses in line with the Council's emerging Core Strategy. The proposals are at an early stage, and will be progressively determined through a detailed site layout exercise. The site will be developed primarily with residential housing of up to 900 units. In addition, a 2FE primary school and community uses including a doctors surgery would be provided within the development.
- 12.6 It has been noted that in previous Local Plan Inquiries, the Inspector has expressed concern that there would be an excessive demand on local Primary Schools for developments of over 400 units, and raised particular concerns about the capacity of local health facilities to cope with additional demand from a new development. The inclusion of a new 2fe Primary School, new doctors surgery and associated community facilities have been included in the proposed scheme in order to address these concerns.
- 12.7 It should be emphasised that central to delivery of the above development is the maximum utilisation and promotion of non car modes of transport, to maximise the sustainability of the development. This will include extended and enhanced bus services, along with a comprehensive network of on-site foot/cycleways linking in to the local networks.
- 12.8 In consultation with the bus operating companies, it is the intention to extent the routes of services 2 and 3 into the development site via suitably designed road systems, which

will conform to the Herts Design Guide. Suitable bus stops would be provided to ensure that all properties would be within a 400m of their nearest stop. In addition, the developer would explore the possibility of improving the H13 service to provide a link to employment areas such as Maylands Industrial area. It should be emphasised that improvements to these bus services would not only cater for the proposed development, but would also provide an enhanced service for the existing community in the vicinity of the site.

- 12.9 Provision of additional controlled crossings will be required, possibly with some enhanced off site foot/cycleway provision. Drawing ST-2189-1-A shows a possible location of such a crossing in Long Chaulden. One such potential foot/cycleway link has been indicated on the Drawing Number ST-2189-23-A, which is located to the south of the site at Chaulden Lane. In addition, a potential pedestrian and cycle link could be made available into Chaulden Lane to the south west of the site which would enable them to use this road to gain access to Winkwell, Grand Union Canal and the A4251 via Pouchen End Lane and Winkwell Lane. However, the nature of these roads is not ideal for such uses due to the winding road alignments and limited visibility.
- 12.10 In order to carry out a robust assessment of the potential effects of the proposed development, this assessment does not rely upon modal shift change from the private car to more sustainable forms of transport, although this will be encouraged through improvements to sustainable transport provision in the surrounding area. The road network and junctions have been assessed to the horizon year of 2031, including Temprow growth and the full envisaged development. The scope of this appraisal and the links and junctions to be considered in this report have been discussed with the Highway Authority, and confirmed to them in Stomor Ltd's letter dated 22nd March 2012.
- 12.11 Stomor Ltd have reviewed reports which were carried out to assess various development proposals for the Fields End site over the past six years. The latest proposals include a new primary school, doctors surgery and community uses. These facilities clearly increase the sustainability credentials of the site and have a beneficial downward effect on the overall trip generation rates.
- 12.12 It should be noted that it is expected that 40% of the housing will be affordable homes. This is likely to have the effect of downward pressure on the trip rates for the development.
- 12.13 The proposed Primary School will be placed in a location within the site to be central to the proposed and existing surrounding housing and local community, with good footway

and cycle links to surrounding residential areas, in order to maximise the opportunities for parents to use non car modes when accompanying children to school.

12.14 Suitable Green Travel Plans (GTP) will be introduced for the proposed uses including the Primary School, residential development and community uses, and submitted with any future planning applications. With respect to the Primary School, the following would be considered:-

- The GTP will be prepared in order to communicate and deliver the opportunities and alternatives to the private car, to encourage a reduction in car travel by both students and staff.
- The GTP will be actively applied, ideally with a designated person in charge of its application and future development.
- Breakfast and after school clubs will be promoted which can have a significant effect in reducing congestion outside a school site during the peak travel periods. Maximising the availability of such facilities would help to minimise traffic impacts associated with expansion of the school.
- There is the opportunity to stagger the Key Stage 1 and 2 start/finish times by approximately 15 minutes. This again has the effect of distributing the traffic peaks over an extended period, thus reducing peak traffic flows.
- With active management of the school travel plan, the number of journeys to or from school made by car could be significantly reduced, particularly as a large percentage of pupils may potentially live within 2km of the school.

12.15 All the above measures will serve to exert downward pressure on car trips, notwithstanding the fact that the local road link and junction network has been assessed in this report as a worst case scenario without modal shift changes.

12.16 With respect to the potential traffic impact resulting from the development, it is anticipated that the local road links should have the capacity to cater for the envisaged 2031 flows including growth and development. The network comprises 6.75m-7.3m wide roads, and the main running carriageways are generally free of parked vehicles, which maximises their effectiveness. This is achieved due to dedicated space in the form of hard verges being provided adjacent to the carriageway, with wide footways behind.

- 12.17 It has been noted from the Steer Davies Gleave report that the localised queuing occurring at Junctions 4 and 5 in Year 2021 would be magnified in the Year 2031 scenario, requiring mitigation measures/improvements.
- 12.18 In addition, they envisaged significant queuing at Junction 6, the Leighton Buzzard Road/Warners End Road Roundabout at Year 2031 with development. It was suggested that signalisation or minor junction re-design may be required.
- 12.19 As confirmed in the report and conclusions below, the Stomor analysis of the local junctions would appear to be compatible with the SDC conclusions.
- 12.20 The local junctions have been assessed in more detail for the most robust scenario using Arcady, Picady and Linsig capacity programmes, for the Horizon Year 2031 with growth and development. In the cases of the new right turn facility main site access in Long Chaulden, and the existing roundabout at The Avenue (Junctions 1 and 2), these will perform satisfactorily and well within capacity.
- 12.21 Junctions 3 – 6 will all require upgrading to cater for both growth and proposed development. Arcady and Linsig runs have been carried out for these junctions at Year 2012 current traffic levels, Year 2031 including growth, and Year 2031 including growth and development. Further runs have been undertaken to test the Year 2031 scenario including growth and development, along with specified junction improvements, in order to reduce the traffic flows and queues back to Year 2031 levels or better with growth only levels; ie nil detriment. Preliminary drawings of the improvements proposed are included with this report.
- 12.22 In the case of Junction 3, the proposed measures should mitigate the effects of the proposed development.
- 12.23 The mini roundabout incorporating Junctions 4/5 is more problematic. Flows in this vicinity are generally high at present on several arms, and queues are experienced under current conditions. We have run various Arcady scenarios, and can probably mitigate the effects at Junction 4. However, Junction 5 cannot be mitigated, even with the improvement works proposed, and it is also in close proximity with Junction 4. Therefore, a double mini roundabout is unlikely to be suitable for future Year 2031 flows. Under this scenario, we have therefore considered a traffic signal solution at this location. Preliminary Linsig calculations have been prepared which indicate that a signal controlled junction could work at this location in the worst case scenario tested.

- 12.24 The roundabout junction at Leighton Buzzard Road connecting with Warners End Road, Junction 6, is busy under current conditions. Background growth to Year 2031 without the Fields End development increases queuing significantly.
- 12.25 The proposed improvements as discussed in this report, taking into account the proposed development, significantly reduce the major queue lengths back to below the Year 2031 growth only levels, and therefore serve to mitigate the effects of the proposed development. Increased traffic at this location is likely to require the intervention of the Highway Authority and a coordinated approach to improvements around the town centre, taking account of the impact of development in the town centre.
- 12.26 Signalisation of this roundabout may possibly be considered by the Highway Authority to increase capacity prior to 2031, depending on the general growth in traffic over the next few years.
- 12.27 It would be reasonable to expect the Highway Authority to play their part in delivering improvements to the junctions as described above, as background traffic growth resulting from developments and other factors other than proposed by the Client developer would still need to be accommodated in the network in due course. Although the improvements suggested in this report are designed to be carried out within the highway boundary and mitigate the effects of the Client's development, the HA may need to use their powers where appropriate if additional land is needed for improvements over and above those suggested in this report.
- 12.28 It should be noted that traffic patterns may well change within the next 20 years, and this report has endeavoured to assess a possible worst case scenario at the links and junctions considered. Should flows increase to levels where queuing and congestion reach unacceptable levels, traffic would tend to redistribute along other routes.
- 12.29 Overall, it is considered that the proposed assignment and distribution of future traffic described in this report represents a robust basis for junction appraisal, to demonstrate that the proposed development of up to 900 houses and a school are deliverable and suitable for allocation, subject to a more detailed transport assessment being prepared as the actual development proposals emerge.
- 12.30 In order to keep traffic generation in the future to the absolute minimum, it will be essential to introduce robust measures to promote the use of sustainable transport modes on all proposed developments in the town to minimise reliance on the private car wherever possible.

- 12.31 The Highways Agency have been consulted by means of their Initial appraisal consultation form, Appendix A of the DfT Guidance on Transport Assessment. Their response is currently awaited, but it is anticipated that a suitable Transport Assessment will be required to accompany future planning applications which pays due regard to the impact of the development on the strategic road network.
- 12.32 Overall, it is considered in transport terms that the proposed development site is suitable to be allocated by the Borough Council in their Core Strategy for Hemel Hempstead, subject to junction improvement works to be discussed, refined and agreed with the Highway Authority.



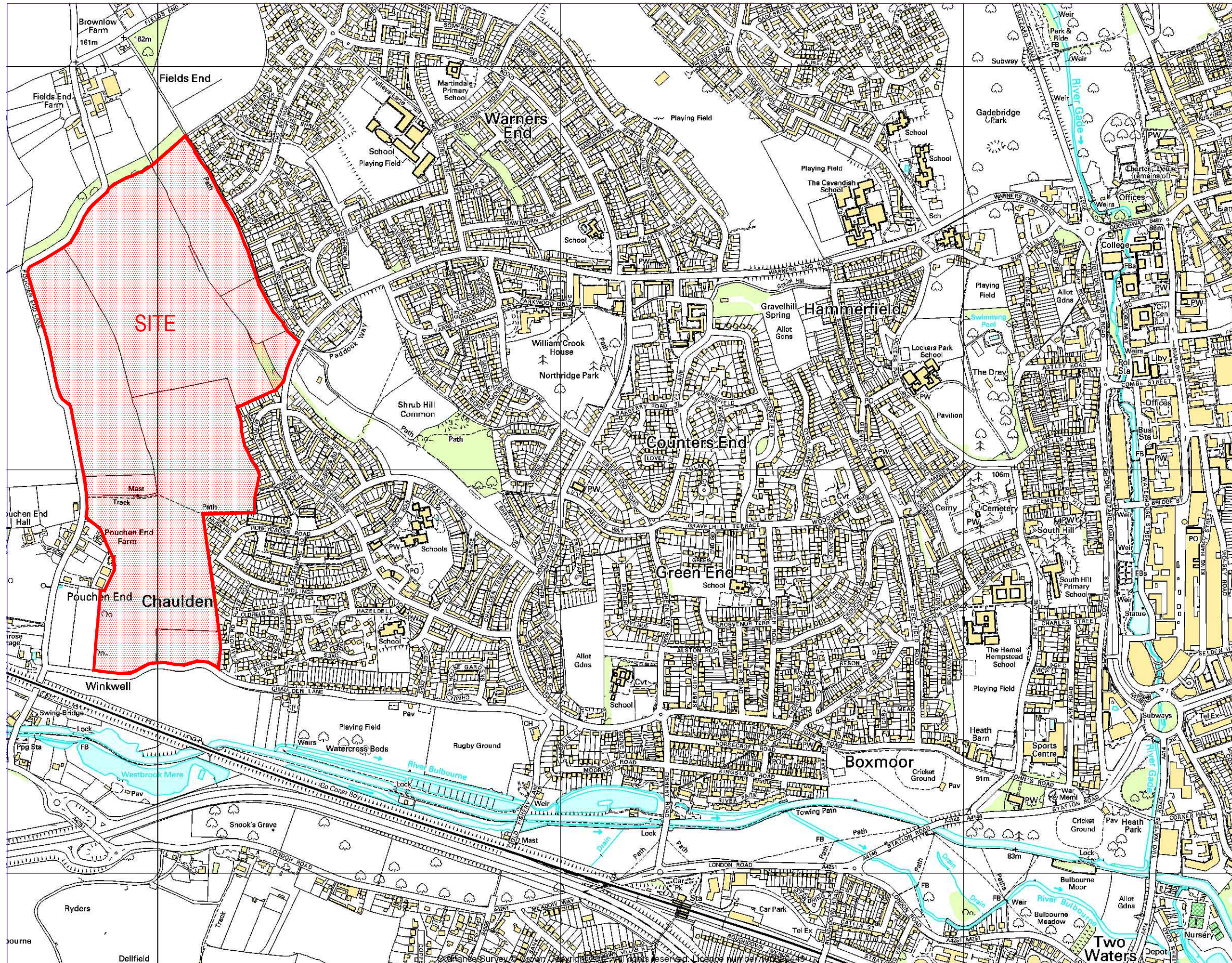

KEY

Site

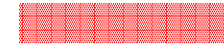

Site Boundary



Rev	Description	Revisions	Date	Drawn	Checked

stomor
CIVIL ENGINEERING CONSULTANTS

Registered Office:
33 Beehive Lane, Welwyn Garden City,
Hertfordshire, AL7 4BQ

Design Office:
19 Waltham Road, Hitchin, Herts, SG4 9SP
Tel 01462 615433 Fax 01462 615425
Email info@stomor.com www.stomor.com

Project

Land at Fields End, Hemel Hempstead

Drawing Description

Site Location Plan

Scale	Date	Drawn By	Checked By
1:10,000 @ A3	02/04/12	LAF	DGS

Client	Architect

Notes

Do not scale off the drawing.
Only written dimensions should be taken.
Any discrepancies or errors should be brought
to the attention of the engineer immediately.

Drawing Number

ST-2189-22



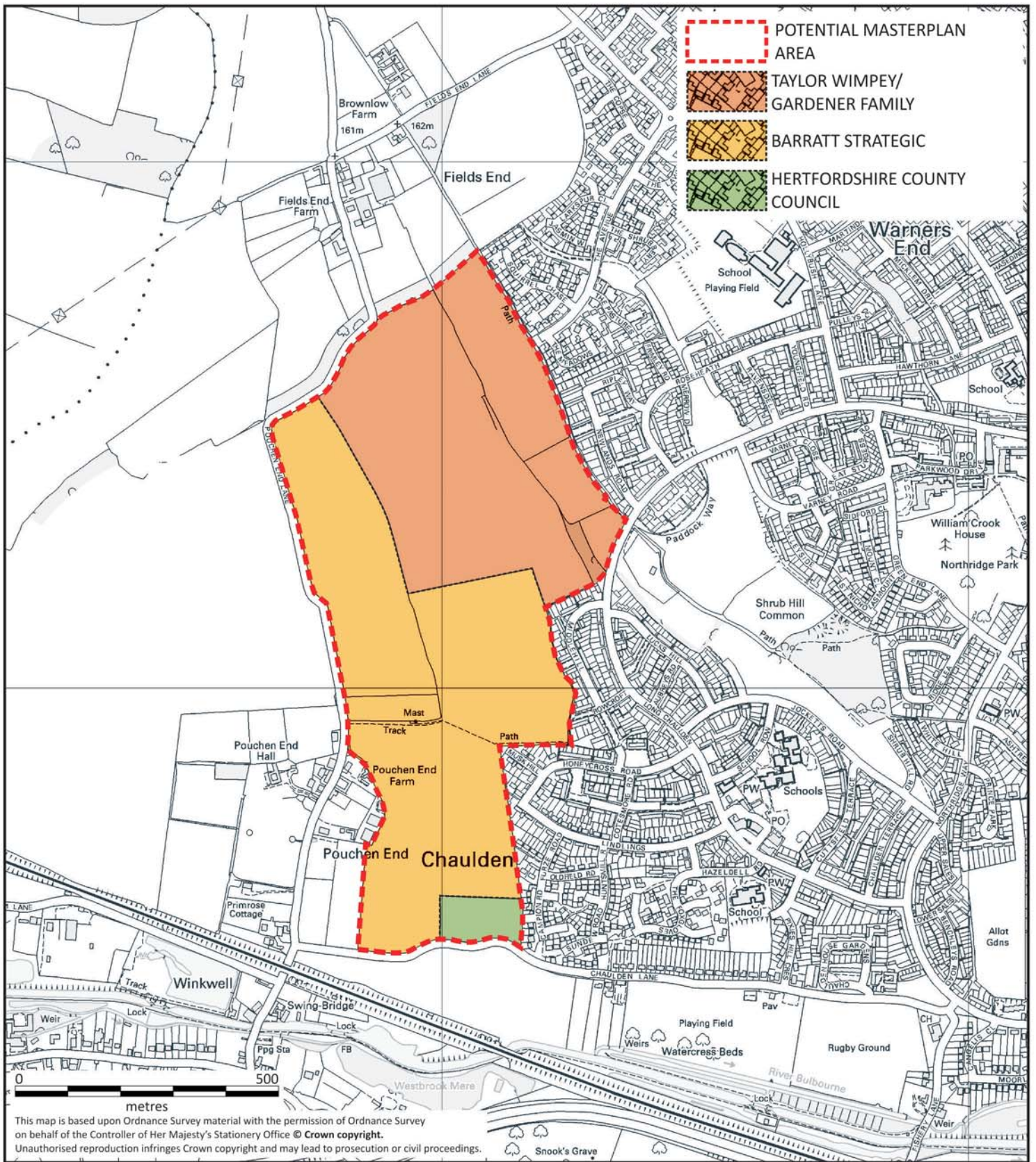

PROJECT TITLE

Land at Fields End
HEMEL HEMPSTEAD
Hertfordshire

DRAWING TITLE

Land ownership

SCALE

1:10000

DATE

NOVEMBER 2011

CHECKED

DRAWN

HNA

DATE

PROJECT No.

4107



301

VINCENT AND GORBING

CHARTERED ARCHITECTS AND TOWN PLANNERS

STERLING COURT NORTON ROAD STEVENAGE HERTS
TELEPHONE: 01438 316331 FAX:01438 722035





Arial Photograph of Fields End,
Hemel Hempstead



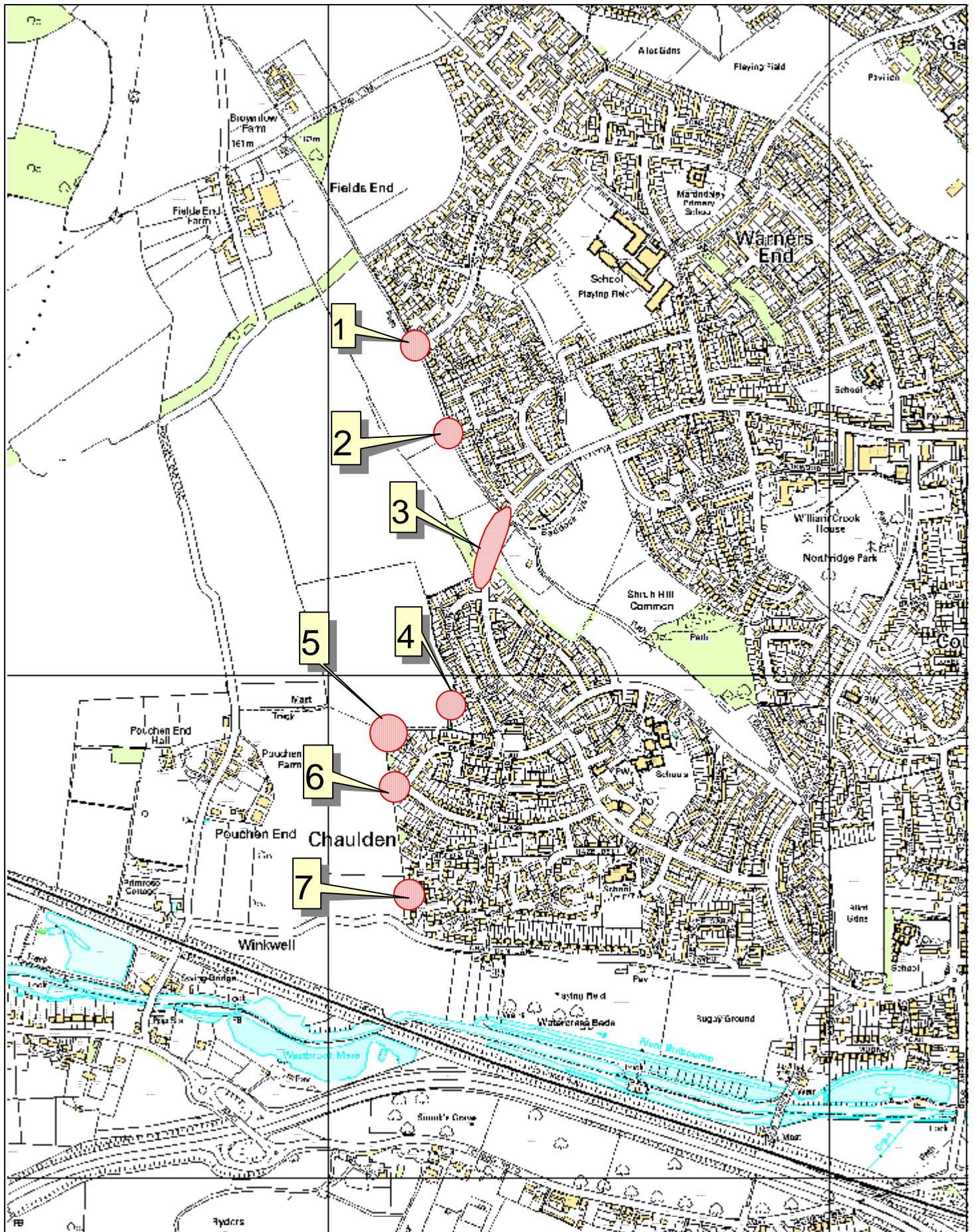

Key Sheet Chaulden, Hemel Hempstead

Scale at A4
1:10000



Produced using ArcView by
HB & LC
Hertfordshire County Council
22 Mar 2012



Public Rights of Way
The Rights of way information on this plan is based on information from the Definitive Map of Public Rights of Way in Hertfordshire ("the Definitive Map"). The accuracy of this plan cannot be guaranteed. If in doubt the Definitive Map should be consulted.

© Crown copyright and database rights 2012 Ordnance Survey 100019606.
Use of this data is subject to terms and conditions.
You are not permitted to copy, sub-licence, distribute or sell any of this data to third parties in any form.
(This restriction may not apply to HCC and its licenced contractors agents and partners.)

For reference purposes only.
No further copies may be made.

For reference purposes only.
No further copies may be made.



Plan 2 West of Chaulden Hemel Hempstead

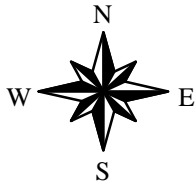

Scale at A4
1:1250

Produced using ArcView by
HB & LC
Hertfordshire County Council
22 Mar 2012

Public Rights of Way
The Rights of way information on this plan is based on information from the Definitive Map of Public Rights of Way in Hertfordshire ("the Definitive Map"). The accuracy of this plan cannot be guaranteed. If in doubt the Definitive Map should be consulted.

© Crown copyright and database rights
2012 Ordnance Survey 100019606.
Use of this data is subject to terms and conditions.
You are not permitted to copy, sub-licence, distribute or sell any of this data to third parties in any form.
(This restriction may not apply to HCC and its licenced contractors agents and partners.)

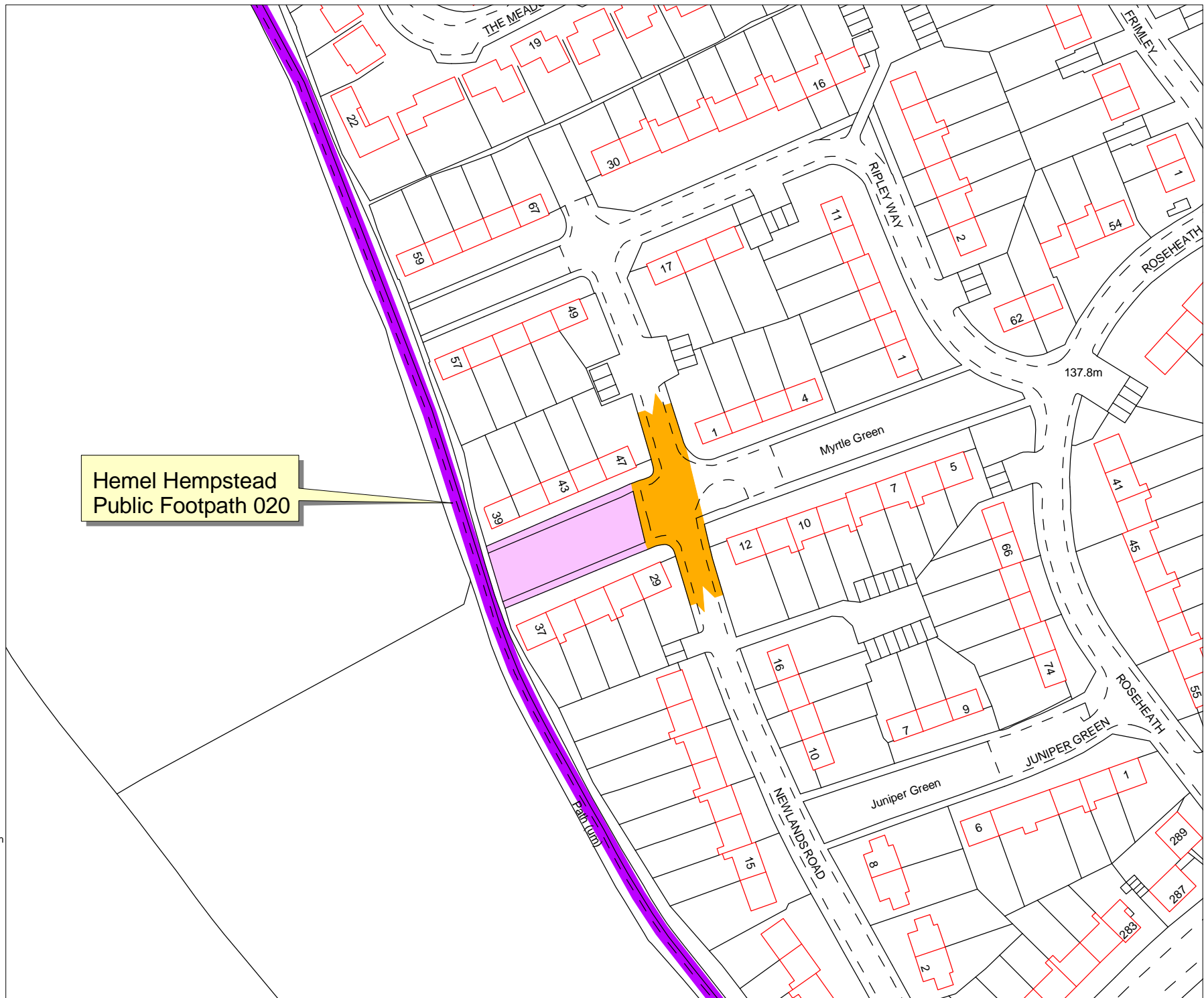

For reference purposes only.
No further copies may be made.



Plan 3 West of Chaulden Hemel Hempstead

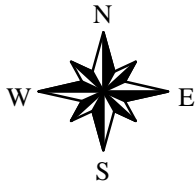

Scale at A4
1:1250

Produced using ArcView by
HB & LC
Hertfordshire County Council
22 Mar 2012

Public Rights of Way
The Rights of way information on this plan is based on information from the Definitive Map of Public Rights of Way in Hertfordshire ("the Definitive Map"). The accuracy of this plan cannot be guaranteed. If in doubt the Definitive Map should be consulted.

© Crown copyright and database rights
2012 Ordnance Survey 100019606.
Use of this data is subject to terms and conditions. You are not permitted to copy, sub-licence, distribute or sell any of this data to third parties in any form. (This restriction may not apply to HCC and its licenced contractors agents and partners.)

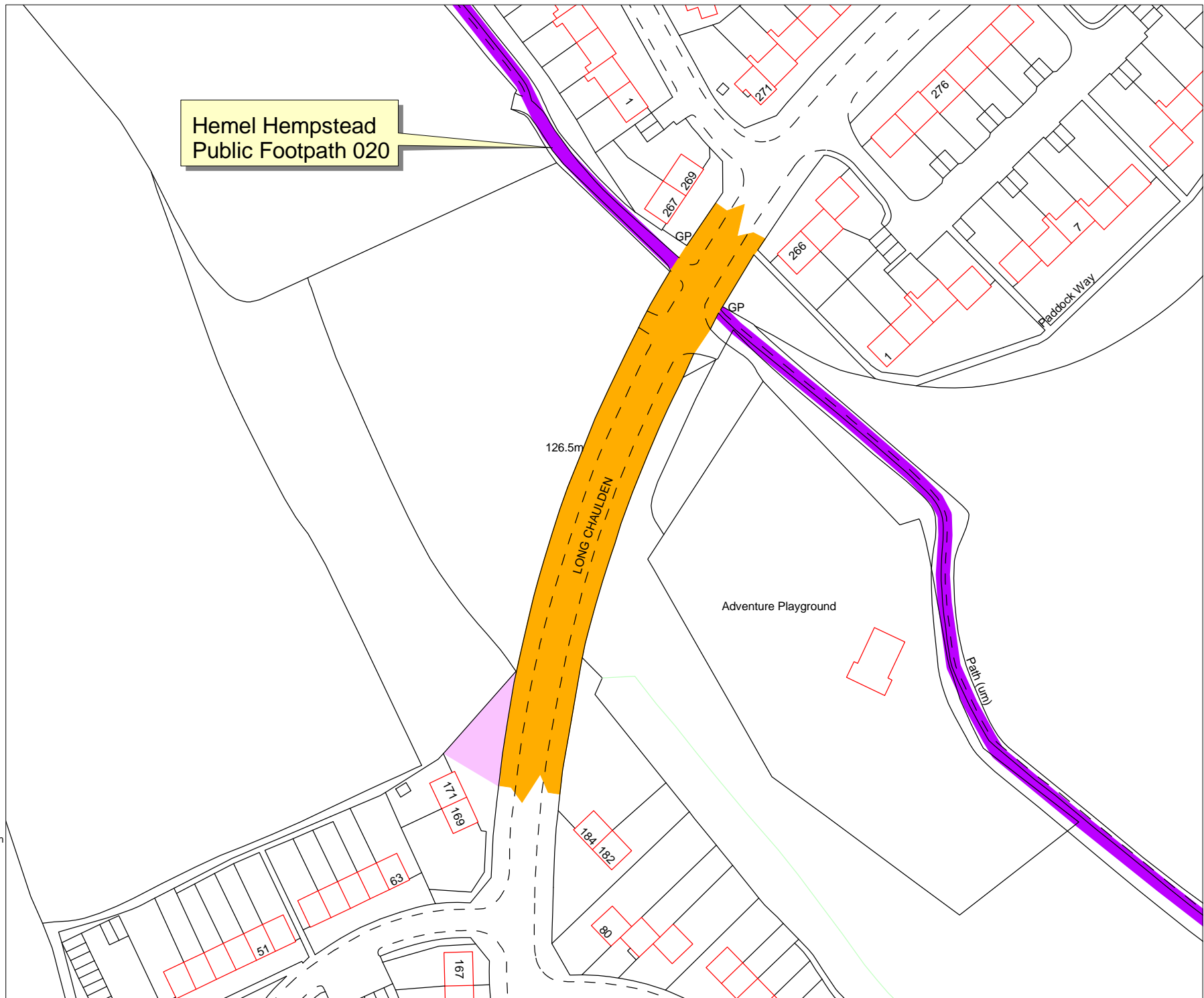

For reference purposes only.
No further copies may be made.



Plan 4 West of Chaulden Hemel Hempstead

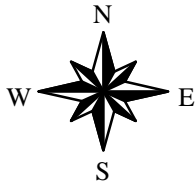

Scale at A4
1:1250

Produced using ArcView by
HB & LC
Hertfordshire County Council
22 Mar 2012

Public Rights of Way
The Rights of way information on this plan is based on information from the Definitive Map of Public Rights of Way in Hertfordshire ("the Definitive Map"). The accuracy of this plan cannot be guaranteed. If in doubt the Definitive Map should be consulted.

© Crown copyright and database rights
2012 Ordnance Survey 100019606.
Use of this data is subject to terms and conditions. You are not permitted to copy, sub-licence, distribute or sell any of this data to third parties in any form. (This restriction may not apply to HCC and its licenced contractors agents and partners.)

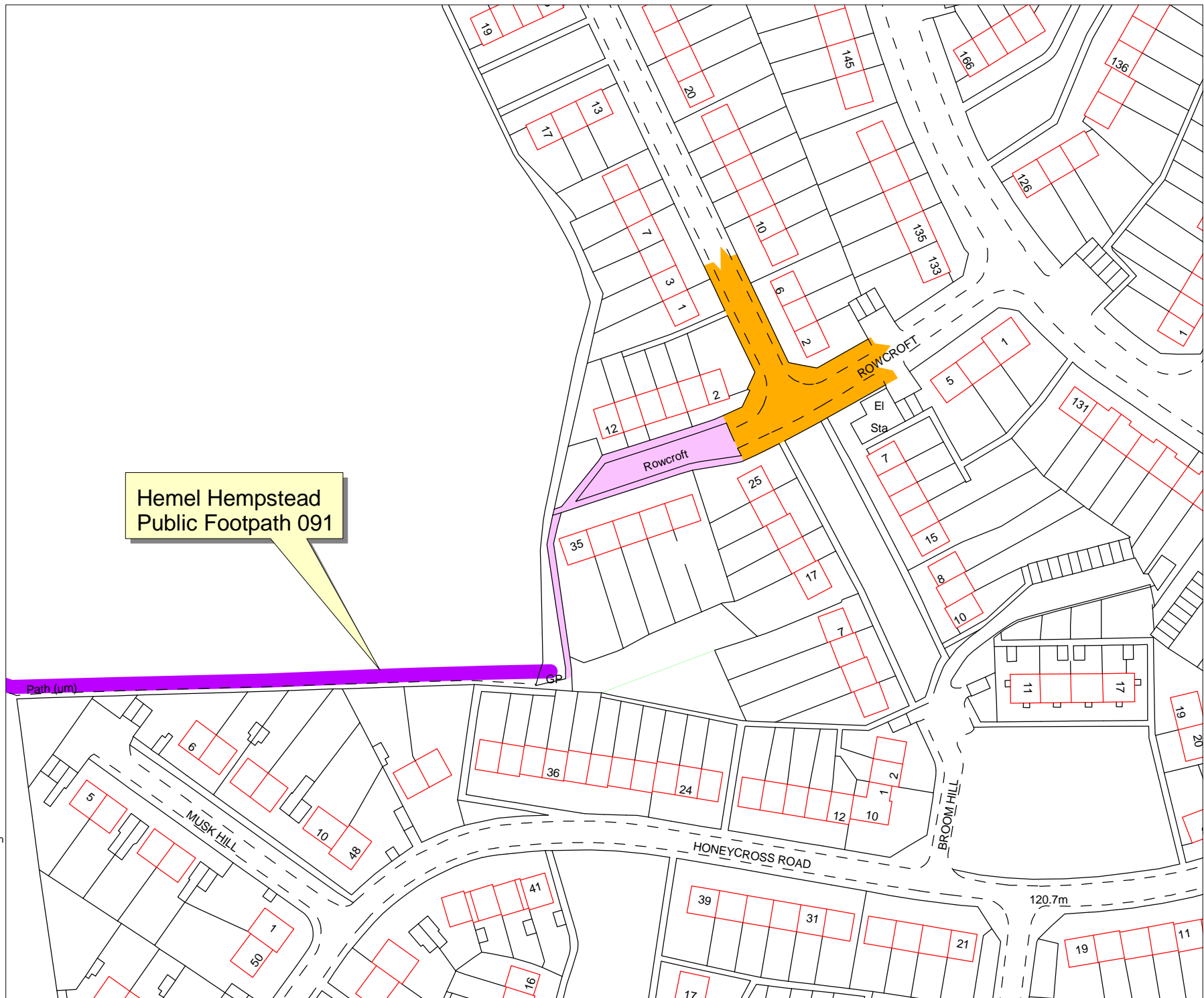

For reference purposes only.
No further copies may be made.



Plan 5 6 West of Chaulden Hemel Hempstead

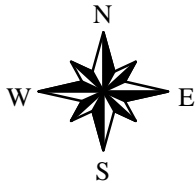

Scale at A4
1:1250

Produced using ArcView by
HB & LC
Hertfordshire County Council
22 Mar 2012

Public Rights of Way
The Rights of way information on this plan is based on information from the Definitive Map of Public Rights of Way in Hertfordshire ("the Definitive Map"). The accuracy of this plan cannot be guaranteed. If in doubt the Definitive Map should be consulted.

© Crown copyright and database rights
2012 Ordnance Survey 100019606.
Use of this data is subject to terms and conditions.
You are not permitted to copy, sub-licence, distribute or sell any of this data to third parties in any form.
(This restriction may not apply to HCC and its licenced contractors agents and partners.)

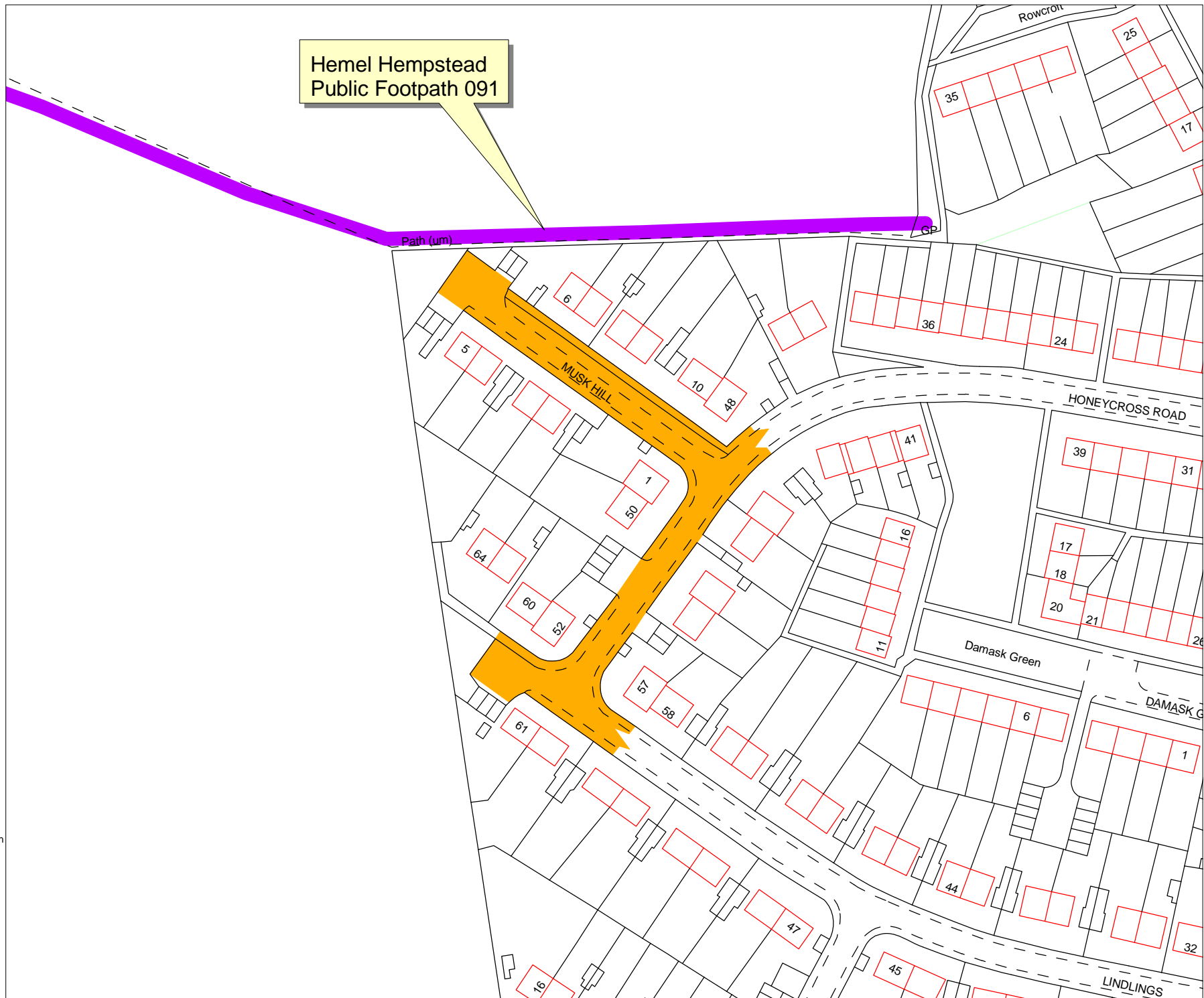

For reference purposes only.
No further copies may be made.



Plan 7 West of Chaulden Hemel Hempstead

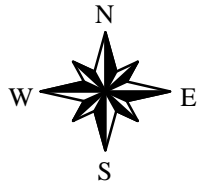

Scale at A4
1:1250

Produced using ArcView by
HB & LC
Hertfordshire County Council
22 Mar 2012

Public Rights of Way
The Rights of way information on this plan is based on information from the Definitive Map of Public Rights of Way in Hertfordshire ("the Definitive Map"). The accuracy of this plan cannot be guaranteed. If in doubt the Definitive Map should be consulted.

© Crown copyright and database rights
2012 Ordnance Survey 100019606.
Use of this data is subject to terms and conditions.
You are not permitted to copy, sub-licence, distribute
or sell any of this data to third parties in any form.
(This restriction may not apply to HCC and
its licenced contractors agents and partners.)

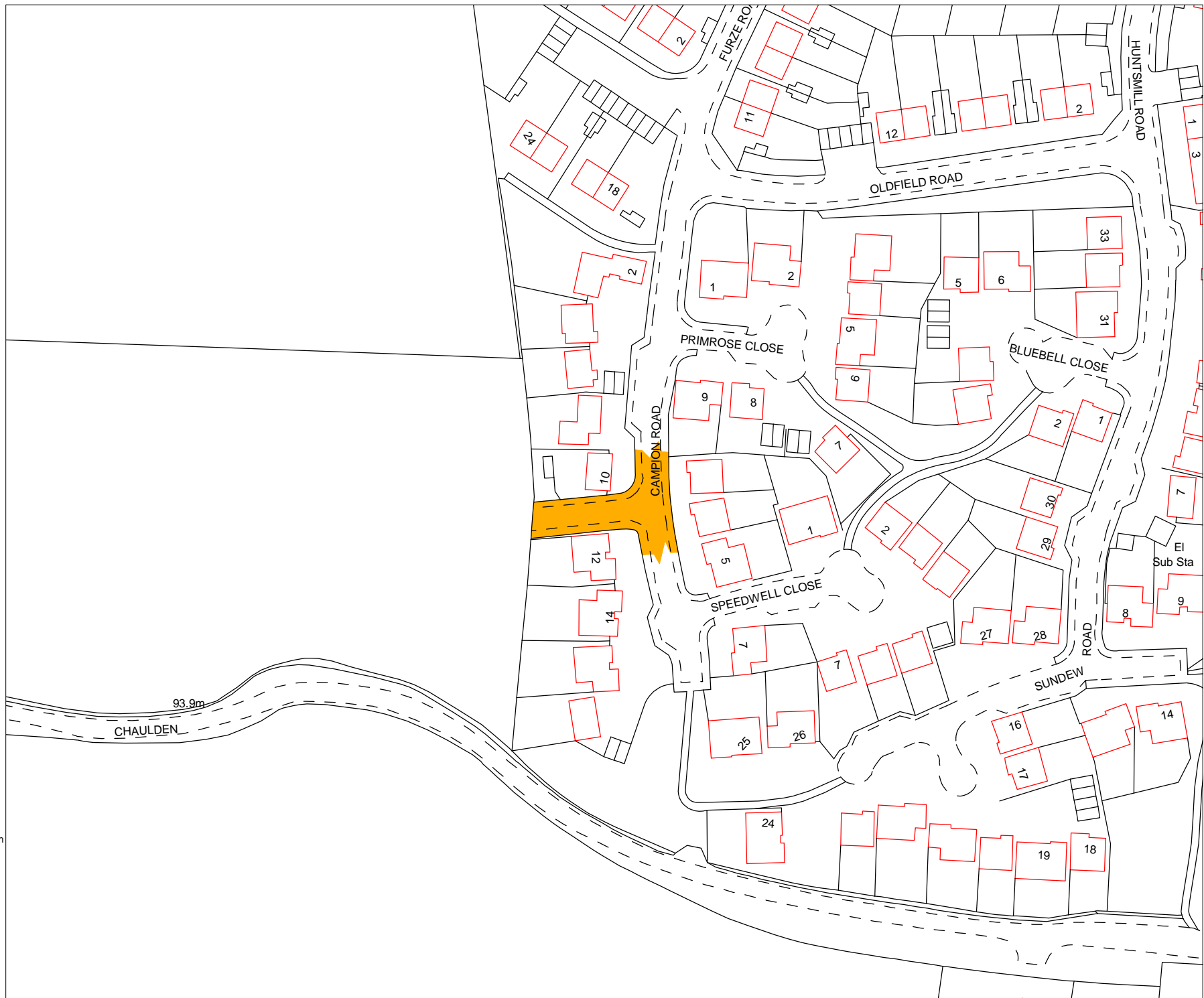



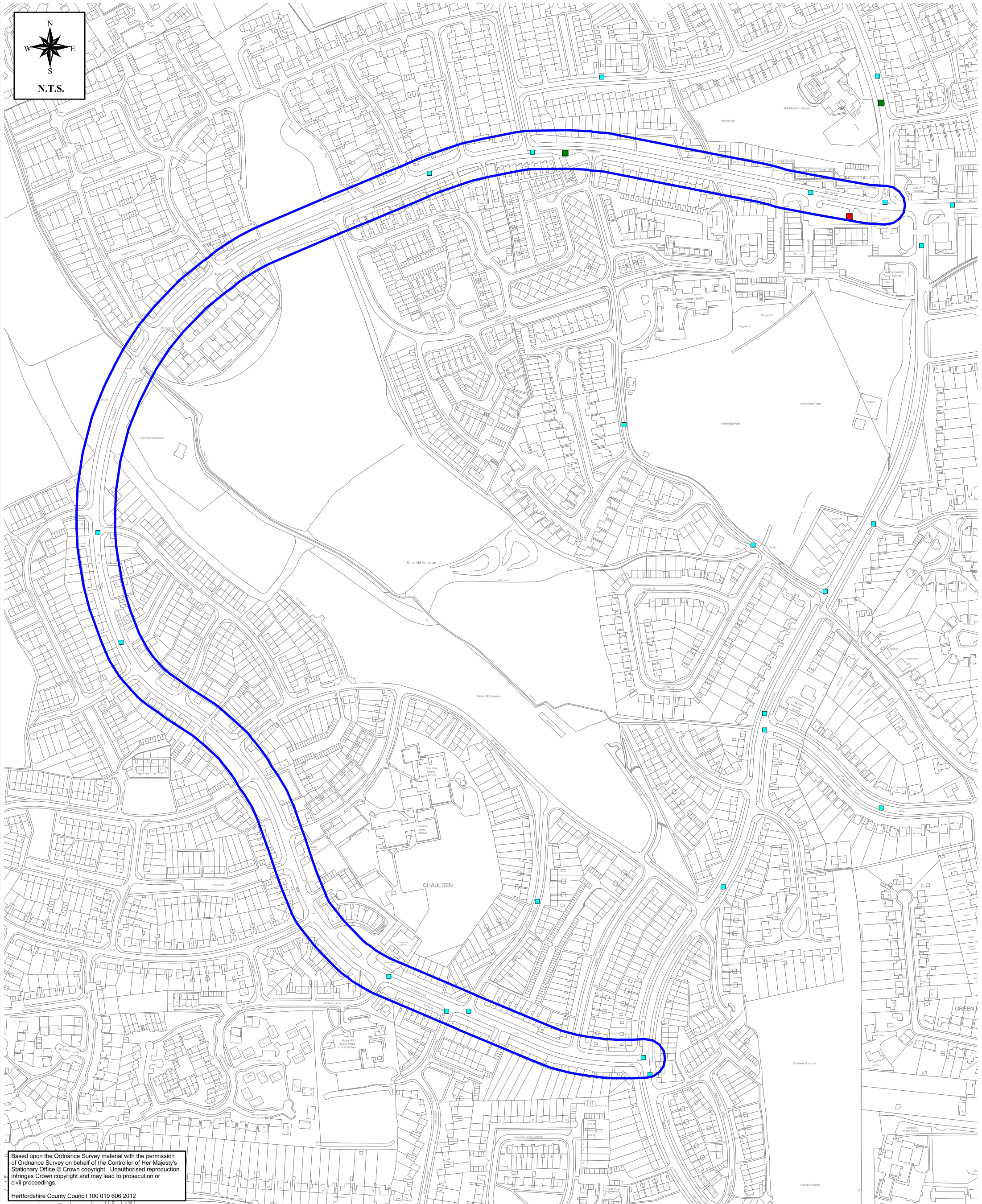

Based upon the Ordnance Survey material with the permission of Ordnance Survey on behalf of the Controller of Her Majesty's Stationary Office © Crown copyright. Unauthorised reproduction infringes Crown copyright and may lead to prosecution or civil proceedings.

Hertfordshire County Council 100 019 606 2012

Hertfordshire Highways
 Highways House
 41 - 45 Broadwater Road
 Welwyn Garden City
 Hertfordshire AL7 3SP
 Tel: +44(0)1707 356200
 Fax: +44(0)1707 356380

Drg No. M/1045008/002/004/17204	Rev 1 of 1 N.T.S.
Drawing Title. Long Chaulden Hemel Hempstead Accidents from 1 Dec 2006 to 30 Nov 2011	Sheet No. Scale. 1 of 1 N.T.S.
Project Title. Accident Data Supply	Project No. 1036856

Legend.

Accidents by Maximum Severity

- Fatal
- Serious
- Slight
- Selection Boundary

Client Org.			
	Prepared	Checked	Approved
Initials	ACN		
Date	Apr 2012		
File.	Not Held		

Full Non Confidential Accident Report

Date Produced: 03-Apr-12

Set Name (if saved) : 17204

Set Total : 13

Accident Details:

Acc Ref: 2011-4100D0137 1st / 2nd Rd: U876/10 U801/10 Jun Detail: Mini Weather: Rain Num Cas: 1
Day of Week: Wed Parish: Hemelhem Jun Control: Gwy/unct Light: Darklit Num Peds: 1
Date: 26/01/2011 17:39:00 District: Dacorum Spec Conditions: None Road Surface: Wet Num Vehicles: 1
Acc Severity: Slight Speed Limit: 30mph C/way Hazard: None C/way Type: Single Ped Xing: Nperzebx
Northridge Way, Hemel Hempstead Est 18m Se Of Mini-rbt J/w Long Chaulden On Site: Yes
Easting: 503888 Northing: 206575

Casualty Details

Acc Ref: 2011-4100D0137 Cas Class: Pedestri Car Passenger: Ped Cas Severity: Slight Ped Movement: Xnrside
Veh Ref: 1 Cas Age: 12 PSV Passenger: Ped Road User Class: Pedestrians Ped Location: Pedcross
Cas Ref: 1 Cas Gender: Male Seat Belt: Notapp School Pupil: Toorfrom Ped Work on Rd: No

Vehicle Details

Acc Ref: 132587 Maneouvre: Ahead Skidding: None Impact Point: Front Driver Breath Test: Negati Driver Age: 64
Veh Ref: 1 Location: Carw Object in Cway: None From: N Hit and Run: Nothtrun
Veh Type: Car+3whl Junction: Exit Object off Cway: None To: Se Driver Gender: Female
Foreign Veh: Notfrv Towing: None velcwy: No J Purpose: Other Driver Severity: None

Accident Details:

Acc Ref: 2010-4100D0894	1st / 2nd Rd: U876/10 U801/10	Jun Detail: Mini	Weather: Fine	Num Cas: 3
Day of Week: Sun	Parish: Hemelhem	Jun Control: Gwy/unct	Light: Darklit	Num Peds: 0
Date: 07/11/2010 18:55:00	District: Dacorum	Spec Conditions: None	Road Surface: Dry	Num Vehicles: 2
Acc Severity: Slight	Speed Limit: 30mph	C/way Hazard: None	C/way Type: R/bout	Ped Xing: Nperpelx
Northridge Way, Hemel Hempstead Mini-rbt J/w Long Chaulden				On Site: Yes
Eastings: 503881	Northing: 206593			

Casualty Details

Acc Ref: 2010-4100D0894	Cas Class: Passenge	Car Passenger: Frontsea	Cas Severity: Slight	Ped Movement: Notped
Veh Ref: 1	Cas Age: 21	PSV Passenger: No	Road User Class: Car Users	Ped Location: Notped
Cas Ref: 1	Cas Gender: Female	Seat Belt: Yes	School Pupil: Other	Ped Work on Rd:

Acc Ref: 2010-4100D0894	Cas Class: Driver	Car Passenger: No	Cas Severity: Slight	Ped Movement: Notped
Veh Ref: 2	Cas Age: 42	PSV Passenger: No	Road User Class: Car Users	Ped Location: Notped
Cas Ref: 2	Cas Gender: Female	Seat Belt: Yes	School Pupil: Other	Ped Work on Rd:

Acc Ref: 2010-4100D0894	Cas Class: Driver	Car Passenger: No	Cas Severity: Slight	Ped Movement: Notped
Veh Ref: 1	Cas Age: 21	PSV Passenger: No	Road User Class: Car Users	Ped Location: Notped
Cas Ref: 3	Cas Gender: Male	Seat Belt: Unknown	School Pupil: Other	Ped Work on Rd:

Vehicle Details

Acc Ref: 132154	Manoeuvre: Turnrigh	Skidding: None	Impact Point: Offside	Driver Breath Test: Negati	Driver Age: 21
Veh Ref: 1	Location: Carw	Object in Cway: None	From: W	Hit and Run: Nothtrun	
Veh Type: Car+3whl	Junction: Et/about	Object off Cway: None	To: S	Driver Gender: Male	
Foreign Veh: Notfrv	Towing: None	velcwy: No	J Purpose: Other	Driver Severity: Slight	

Acc Ref:	Manoeuvre: Ahead	Skidding: None	Impact Point: Front	Driver Breath Test: Negati	Driver Age: 42
Veh Ref: 2	Location: Carw	Object in Cway: None	From: S	Hit and Run: Nothtrun	
Veh Type: Car+3whl	Junction: Middle	Object off Cway: None	To: N	Driver Gender: Female	
Foreign Veh: Notfrv	Towing: None	velcwy: No	J Purpose: Other	Driver Severity: Slight	

Accident Details:

Acc Ref: 2011-4100D0157	1st / 2nd Rd: U801/10 U606/10	Jun Detail: T	Weather: Other	Num Cas: 1
Day of Week: Fri	Parish: Hemelhem	Jun Control: Gwy/unct	Light: Darklit	Num Peds: 0
Date: 11/03/2011 21:20:00	District: Dacorum	Spec Conditions: None	Road Surface: Dry	Num Vehicles: 2
Acc Severity: Slight	Speed Limit: 30mph	C/way Hazard: None	C/way Type: Single	Ped Xing: Npercntr

Long Chaulden, Hemel Hempstead J/w Cuttsfield Terrace

Easting: 503700	Northing: 206641	On Site: No-otc
------------------------	-------------------------	------------------------

Casualty Details

Acc Ref: 2011-4100D0157	Cas Class: Driver	Car Passenger: No	Cas Severity: Slight	Ped Movement: Notped
Veh Ref: 1	Cas Age: 52	PSV Passenger: No	Road User Class: Cyclists	Ped Location: Notped
Cas Ref: 1	Cas Gender: Male	Seat Belt: Notapp	School Pupil: Other	Ped Work on Rd:

Vehicle Details

Acc Ref: 132924	Manoeuvre: Ahead	Skidding: None	Impact Point: Front	Driver Breath Test: Notapp	Driver Age: 52
Veh Ref: 1	Location: Carw	Object in Cway: None	From: Nw	Hit and Run: Nothtrun	
Veh Type: Bicycle	Junction: Emain	Object off Cway None	To: Se	Driver Gender: Male	
Foreign Veh: Notfrv	Towing; None	velcwy No	J Purpose: Other	Driver Severity: Slight	

Acc Ref:	Manoeuvre: Turnrigh	Skidding: None	Impact Point: Offside	Driver Breath Test: Notcon	Driver Age: 54
Veh Ref: 2	Location: Carw	Object in Cway: None	From: Ne	Hit and Run: Nothtrun	
Veh Type: Car+3whl	Junction: Middle	Object off Cway None	To: Nw	Driver Gender: Male	
Foreign Veh: Notfrv	Towing; None	velcwy No	J Purpose: Other	Driver Severity: None	

Accident Details:

Acc Ref: 2009-4100D0845	1st / 2nd Rd: U916/10 U801/10	Jun Detail: T	Weather: Fine	Num Cas: 1
Day of Week: Fri	Parish: Hemelhem	Jun Control: Gwy/unct	Light: Daystlts	Num Peds: 0
Date: 06/11/2009 12:03:00	District: Dacorum	Spec Conditions: None	Road Surface: Dry	Num Vehicles: 2
Acc Severity: Slight	Speed Limit: 30mph	C/way Hazard: None	C/way Type: Single	Ped Xing: Npernox

Pixies Hill Road, Hemel Hempstead 7m Sw Of J/w Long Chaulden

Easting: 503677	Northing: 206641	On Site: Yes
------------------------	-------------------------	---------------------

Casualty Details

Acc Ref: 2009-4100D0845	Cas Class: Driver	Car Passenger: No	Cas Severity: Slight	Ped Movement: Notped
Veh Ref: 1	Cas Age: 27	PSV Passenger: No	Road User Class: Cyclists	Ped Location: Notped
Cas Ref: 1	Cas Gender: Male	Seat Belt: Notapp	School Pupil: Other	Ped Work on Rd:

Vehicle Details

Acc Ref: 129220	Manoeuvre: Ahead	Skidding: None	Impact Point: Front	Driver Breath Test: Negati	Driver Age: 27
Veh Ref: 1	Location: Carw	Object in Cway: None	From: Nw	Hit and Run: Nothtrun	
Veh Type: Bicycle	Junction: Approach	Object off Cway None	To: Se	Driver Gender: Male	
Foreign Veh: Notfrv	Towing; None	velcwy No	J Purpose: Other	Driver Severity: Slight	

Acc Ref:	Manoeuvre: Waitleft	Skidding: None	Impact Point: Nearside	Driver Breath Test: Negati	Driver Age: 57
Veh Ref: 2	Location: Carw	Object in Cway: None	From: Sw	Hit and Run: Nothtrun	
Veh Type: Car+3whl	Junction: Approach	Object off Cway None	To: Nw	Driver Gender: Female	
Foreign Veh: Notfrv	Towing; None	velcwy No	J Purpose: Other	Driver Severity: None	

Accident Details:

Acc Ref: 2009-4100D0470	1st / 2nd Rd: U801/10 U724/10	Jun Detail: T	Weather: Fine	Num Cas: 1
Day of Week: Sun	Parish: Hemelhem	Jun Control: Gwy/unct	Light: Darklit	Num Peds: 1
Date: 21/06/2009 00:36:00	District: Dacorum	Spec Conditions: None	Road Surface: Dry	Num Vehicles: 1
Acc Severity: Slight	Speed Limit: 30mph	C/way Hazard: None	C/way Type: Single	Ped Xing: Npernox

Long Chaulden, Hemel Hempstead Est 8m Se Of J/w Hazeldell Road, Outside Tudor Rose P.h.

Easting: 503617	Northing: 206677
------------------------	-------------------------

Casualty Details

Acc Ref: 2009-4100D0470	Cas Class: Pedestri	Car Passenger: Ped	Cas Severity: Slight	Ped Movement: Xnrside
Veh Ref: 1	Cas Age: 59	PSV Passenger: Ped	Road User Class: Pedestrians	Ped Location: Elsewher
Cas Ref: 1	Cas Gender: Male	Seat Belt: Notapp	School Pupil: Other	Ped Work on Rd: No

Vehicle Details

Acc Ref: 128133	Manoeuvre: Leftbend	Skidding: None	Impact Point: Front	Driver Breath Test: Positiv	Driver Age: 20
Veh Ref: 1	Location: Carw	Object in Cway: None	From: Nw	Hit and Run: Nothtrun	
Veh Type: Car+3whl	Junction: Exit	Object off Cway: None	To: Se	Driver Gender: Female	
Foreign Veh: Notfrv	Towing: None	velewy: No	J Purpose: Other	Driver Severity: None	

Accident Details:

Acc Ref: 2008-4100D0440	1st / 2nd Rd: U801/10	Jun Detail: Notjunct	Weather: Fine	Num Cas: 1
Day of Week: Sat	Parish: Hemelhem	Jun Control: Notjunct	Light: Daystlts	Num Peds: 1
Date: 14/06/2008 17:30:00	District: Dacorum	Spec Conditions: None	Road Surface: Dry	Num Vehicles: 2
Acc Severity: Slight	Speed Limit: 30mph	C/way Hazard: None	C/way Type: Single	Ped Xing: Npernox
Long Chaulden Hemel Hempstead Est 35m North J/w Rowcroft				On Site: Yes
Easting: 503339	Northing: 207024			

Casualty Details

Acc Ref: 2008-4100D0440	Cas Class: Pedestri	Car Passenger: Ped	Cas Severity: Slight	Ped Movement: Cwaystil
Veh Ref: 1	Cas Age: 34	PSV Passenger: Ped	Road User Class: Pedestrians	Ped Location: Incway
Cas Ref: 1	Cas Gender: Male	Seat Belt: Notapp	School Pupil: Other	Ped Work on Rd: No

Vehicle Details

Acc Ref: 125234	Manoeuvre: Ahead	Skidding: None	Impact Point: Nearside	Driver Breath Test: Negati	Driver Age: 39
Veh Ref: 1	Location: Carw	Object in Cway: None	From: S	Hit and Run: Nothtrun	
Veh Type: Gdltwght	Junction: Notjunct	Object off Cway None	To: N	Driver Gender: Male	
Foreign Veh: Notfrv	Towing; None	velcwy No	J Purpose: Other	Driver Severity: None	
<hr/>					
Acc Ref:	Manoeuvre: Parked	Skidding: None	Impact Point: None	Driver Breath Test: Negati	Driver Age: 33
Veh Ref: 2	Location: Carw	Object in Cway: None	From: Still	Hit and Run: Nothtrun	
Veh Type: Car+3whl	Junction: Notjunct	Object off Cway None	To: Still	Driver Gender: Female	
Foreign Veh: Notfrv	Towing; None	velcwy No	J Purpose: Other	Driver Severity: None	

Accident Details:

Acc Ref: 2009-4100D0384	1st / 2nd Rd: U801/10 U811/10	Jun Detail: T	Weather: Fine	Num Cas: 3
Day of Week: Sat	Parish: Hemelhem	Jun Control: Gwy/unct	Light: Daystlts	Num Peds: 0
Date: 16/05/2009 13:20:00	District: Dacorum	Spec Conditions: None	Road Surface: Dry	Num Vehicles: 2
Acc Severity: Slight	Speed Limit: 30mph	C/way Hazard: None	C/way Type: Single	Ped Xing: Npernox
Long Chaulden, Hemel Hempstead J/w Lucks Hill				On Site: Yes
Eastings: 503315	Northing: 207138			

Casualty Details

Acc Ref: 2009-4100D0384	Cas Class: Passenge	Car Passenger: Frontsea	Cas Severity: Slight	Ped Movement: Notped
Veh Ref: 2	Cas Age: 13	PSV Passenger: No	Road User Class: Car Users	Ped Location: Notped
Cas Ref: 1	Cas Gender: Male	Seat Belt: Yes	School Pupil: Other	Ped Work on Rd:

Acc Ref: 2009-4100D0384	Cas Class: Passenge	Car Passenger: Rearseat	Cas Severity: Slight	Ped Movement: Notped
Veh Ref: 2	Cas Age: 10	PSV Passenger: No	Road User Class: Car Users	Ped Location: Notped
Cas Ref: 2	Cas Gender: Female	Seat Belt: Yes	School Pupil: Other	Ped Work on Rd:

Acc Ref: 2009-4100D0384	Cas Class: Passenge	Car Passenger: Rearseat	Cas Severity: Slight	Ped Movement: Notped
Veh Ref: 2	Cas Age: 7	PSV Passenger: No	Road User Class: Car Users	Ped Location: Notped
Cas Ref: 3	Cas Gender: Male	Seat Belt: Yes	School Pupil: Other	Ped Work on Rd:

Vehicle Details

Acc Ref: 127896	Manoeuvre: Waitrigh	Skidding: None	Impact Point: Offside	Driver Breath Test: Negati	Driver Age: 45
Veh Ref: 1	Location: Carw	Object in Cway: None	From: Se	Hit and Run: Nothtrun	
Veh Type: Gdltwght	Junction: Emain	Object off Cway: None	To: N	Driver Gender: Male	
Foreign Veh: Notfrv	Towing: None	velcwy: No	J Purpose: Work	Driver Severity: None	

Acc Ref:	Manoeuvre: Leftbend	Skidding: None	Impact Point: Front	Driver Breath Test: Negati	Driver Age: 39
Veh Ref: 2	Location: Carw	Object in Cway: None	From: N	Hit and Run: Nothtrun	
Veh Type: Car+3whl	Junction: Middle	Object off Cway: None	To: S	Driver Gender: Female	
Foreign Veh: Notfrv	Towing: None	velcwy: No	J Purpose: Tofrowrk	Driver Severity: None	

Accident Details:

Acc Ref: 2009-4100D0820	1st / 2nd Rd: U1021/1	Jun Detail: Notjunct	Weather: Rain	Num Cas: 1
Day of Week: Tue	Parish: Hemelhem	Jun Control: Notjunct	Light: Daystlts	Num Peds: 1
Date: 10/11/2009 10:25:00	District: Dacorum	Spec Conditions: None	Road Surface: Wet	Num Vehicles: 1
Acc Severity: Fatal	Speed Limit: 30mph	C/way Hazard: None	C/way Type: Single	Ped Xing: Npernox

Stoneycroft, Hemel Hempstead 57m Se Of J/w Long Chaulden

Easting: 504095	Northing: 207466	On Site: Yes
------------------------	-------------------------	---------------------

Casualty Details

Acc Ref: 2009-4100D0820	Cas Class: Pedestri	Car Passenger: Ped	Cas Severity: Fatal	Ped Movement: Xoffside
Veh Ref: 1	Cas Age: 83	PSV Passenger: Ped	Road User Class: Pedestrians	Ped Location: Unknown
Cas Ref: 1	Cas Gender: Male	Seat Belt: Notapp	School Pupil: Other	Ped Work on Rd: No

Vehicle Details

Acc Ref: 129215	Manoeuvre: Reverse	Skidding: None	Impact Point: Back	Driver Breath Test: Notreq	Driver Age: 80
Veh Ref: 1	Location: Carw	Object in Cway: None	From: Se	Hit and Run: Nothtrun	
Veh Type: Car+3whl	Junction: Notjunct	Object off Cway: None	To: Nw	Driver Gender: Female	
Foreign Veh: Notfrv	Towing: None	velewy: No	J Purpose: Other	Driver Severity: None	

Accident Details:

Acc Ref: 2008-4100D0190	1st / 2nd Rd: U1076/1 U505/10	Jun Detail: Mini	Weather: Rain	Num Cas: 1
Day of Week: Sat	Parish: Hemelhem	Jun Control: Gwy/unct	Light: Darklit	Num Peds: 0
Date: 08/03/2008 20:00:00	District: Dacorum	Spec Conditions: None	Road Surface: Wet	Num Vehicles: 2
Acc Severity: Slight	Speed Limit: 30mph	C/way Hazard: None	C/way Type: R/bout	Ped Xing: Nperpelx
Warners End Road, Hemel Hempstead Mini-rbt J/w Boxted Road & Long Chaulden				On Site: Yes
Easting: 504132	Northing: 207481			

Casualty Details

Acc Ref: 2008-4100D0190	Cas Class: Driver	Car Passenger: No	Cas Severity: Slight	Ped Movement: Notped
Veh Ref: 2	Cas Age: 19	PSV Passenger: No	Road User Class: Car Users	Ped Location: Notped
Cas Ref: 1	Cas Gender: Male	Seat Belt: Unknown	School Pupil: Other	Ped Work on Rd:

Vehicle Details

Acc Ref: 124461	Manoeuvre: Ahead	Skidding: None	Impact Point: Front	Driver Breath Test: Negati	Driver Age: 19
Veh Ref: 1	Location: Carw	Object in Cway: None	From: Nw	Hit and Run: Nothtrun	
Veh Type: Car+3whl	Junction: Middle	Object off Cway None	To: Se	Driver Gender: Male	
Foreign Veh: Notfrv	Towing; None	velwy No	J Purpose: Other	Driver Severity: None	
Acc Ref:	Manoeuvre: Turnrigh	Skidding: None	Impact Point: Offside	Driver Breath Test: Negati	Driver Age: 19
Veh Ref: 2	Location: Carw	Object in Cway: None	From: Se	Hit and Run: Nothtrun	
Veh Type: Car+3whl	Junction: Middle	Object off Cway None	To: N	Driver Gender: Male	
Foreign Veh: Notfrv	Towing; None	velwy No	J Purpose: Other	Driver Severity: Slight	

Accident Details:

Acc Ref: 2008-4100D0189	1st / 2nd Rd: U801/10 U1021/1	Jun Detail: T	Weather: Other	Num Cas: 1
Day of Week: Wed	Parish: Hemelhem	Jun Control: Gwy/unct	Light: Daystlts	Num Peds: 0
Date: 05/03/2008 07:12:00	District: Dacorum	Spec Conditions: None	Road Surface: Frostice	Num Vehicles: 2
Acc Severity: Slight	Speed Limit: 30mph	C/way Hazard: None	C/way Type: Single	Ped Xing: Npernox

Long Chaulden, Hemel Hempstead 5m Nw Of J/w Stoneycroft

Easting: 504055	Northing: 207491
------------------------	-------------------------

Casualty Details

Acc Ref: 2008-4100D0189	Cas Class: Driver	Car Passenger: No	Cas Severity: Slight	Ped Movement: Notped
Veh Ref: 2	Cas Age: 67	PSV Passenger: No	Road User Class: Car Users	Ped Location: Notped
Cas Ref: 1	Cas Gender: Male	Seat Belt: Yes	School Pupil: Other	Ped Work on Rd:

Vehicle Details

Acc Ref: 124460	Manoeuvre: Ahead	Skidding: None	Impact Point: Front	Driver Breath Test: Notreq	Driver Age: 42
Veh Ref: 1	Location: Carw	Object in Cway: None	From: Nw	Hit and Run: Nothtrun	
Veh Type: Car+3whl	Junction: Approach	Object off Cway None	To: Se	Driver Gender: Female	
Foreign Veh: Notfrv	Towing; None	velcwy No	J Purpose: Work	Driver Severity: None	

Acc Ref:	Manoeuvre: Waitrigh	Skidding: None	Impact Point: Back	Driver Breath Test: Ntprov	Driver Age: 67
Veh Ref: 2	Location: Carw	Object in Cway: None	From: Nw	Hit and Run: Nothtrun	
Veh Type: Car+3whl	Junction: Approach	Object off Cway None	To: S	Driver Gender: Male	
Foreign Veh: Notfrv	Towing; None	velcwy No	J Purpose: Other	Driver Severity: Slight	

Accident Details:

Acc Ref: 2011-4100D0757	1st / 2nd Rd: U801/10 U936/10	Jun Detail: T	Weather: Fine	Num Cas: 1
Day of Week: Wed	Parish: Hemelhem	Jun Control: Gwy/unct	Light: Daystlts	Num Peds: 0
Date: 26/10/2011 11:40:00	District: Dacorum	Spec Conditions: None	Road Surface: Dry	Num Vehicles: 2
Acc Severity: Slight	Speed Limit: 30mph	C/way Hazard: None	C/way Type: Single	Ped Xing: Npernox

Long Chaulden, Hemel Hempstead, Approx 10m East J/w Ravensdell

Eastings: 503659	Northing: 207511	On Site: Yes
-------------------------	-------------------------	---------------------

Casualty Details

Acc Ref: 2011-4100D0757	Cas Class: Driver	Car Passenger: No	Cas Severity: Slight	Ped Movement: Notped
Veh Ref: 2	Cas Age: 26	PSV Passenger: No	Road User Class: Motorcyclists	Ped Location: Notped
Cas Ref: 1	Cas Gender: Male	Seat Belt: Notapp	School Pupil: Other	Ped Work on Rd:

Vehicle Details

Acc Ref: 134449	Manoeuvre: Reverse	Skidding: None	Impact Point: Back	Driver Breath Test: Notreq	Driver Age: 23
Veh Ref: 1	Location: Carw	Object in Cway: None	From: W	Hit and Run: Nothtrun	
Veh Type: Gdltwght	Junction: Exit	Object off Cway: None	To: E	Driver Gender: Male	
Foreign Veh: Notfrv	Towing: None	velwy: No	J Purpose: Work	Driver Severity: None	

Acc Ref:	Manoeuvre: Waitahea	Skidding: None	Impact Point: Front	Driver Breath Test: Notreq	Driver Age: 26
Veh Ref: 2	Location: Carw	Object in Cway: None	From: W	Hit and Run: Nothtrun	
Veh Type: Mc<=125	Junction: Exit	Object off Cway: None	To: E	Driver Gender: Male	
Foreign Veh: Notfrv	Towing: None	velwy: No	J Purpose: Other	Driver Severity: Slight	

Accident Details:

Acc Ref: 2010-4100D0458	1st / 2nd Rd: U801/10	Jun Detail: Notjunct	Weather: Fine	Num Cas: 1
Day of Week: Fri	Parish: Hemelhem	Jun Control: Notjunct	Light: Daystlts	Num Peds: 0
Date: 25/06/2010 19:50:00	District: Dacorum	Spec Conditions: None	Road Surface: Dry	Num Vehicles: 1
Acc Severity: Serious	Speed Limit: 30mph	C/way Hazard: None	C/way Type: Single	Ped Xing: Npernox

Long Chaulden, Hemel Hempstead Exact Location Not Recorded, Gridded 28m West Of J/w Varney Road

Easting: 503800	Northing: 207532
------------------------	-------------------------

Casualty Details

Acc Ref: 2010-4100D0458	Cas Class: Passenge	Car Passenger: No	Cas Severity: Serious	Ped Movement: Notped
Veh Ref: 1	Cas Age: 2	PSV Passenger: Seated	Road User Class: PSV's	Ped Location: Notped
Cas Ref: 1	Cas Gender: Male	Seat Belt: Notapp	School Pupil: Other	Ped Work on Rd:

Vehicle Details

Acc Ref: 130878	Manoeuvre: Parked	Skidding: None	Impact Point: None	Driver Breath Test: Notcon	Driver Age: 36
Veh Ref: 1	Location: Carw	Object in Cway: None	From: Still	Hit and Run: Nothtrun	
Veh Type: Psv	Junction: Notjunct	Object off Cway: None	To: Still	Driver Gender: Male	
Foreign Veh: Notfrv	Towing: None	velewy: No	J Purpose: Work	Driver Severity: None	

Accident Details:

Acc Ref: 2007-4100D0027	1st / 2nd Rd: U801/10 U750/10	Jun Detail: T	Weather: Finewind	Num Cas: 1
Day of Week: Sat	Parish: Hemelhem	Jun Control: Gwy/unct	Light: Daystlts	Num Peds: 0
Date: 20/01/2007 13:20:00	District: Dacorum	Spec Conditions: None	Road Surface: Dry	Num Vehicles: 2
Acc Severity: Slight	Speed Limit: 30mph	C/way Hazard: None	C/way Type: Single	Ped Xing: Npernox

Long Chaulden, Hemel Hempstead Est 5m Se Of J/w Hollybush Lane

Eastings: 503766	Northing: 207533
-------------------------	-------------------------

Casualty Details

Acc Ref: 2007-4100D0027	Cas Class: Driver	Car Passenger: No	Cas Severity: Slight	Ped Movement: Notped
Veh Ref: 1	Cas Age: 18	PSV Passenger: No	Road User Class: Car Users	Ped Location: Notped
Cas Ref: 1	Cas Gender: Male	Seat Belt: Yes	School Pupil: Other	Ped Work on Rd:

Vehicle Details

Acc Ref: 120361	Manoeuvre: Leftbend	Skidding: None	Impact Point: Front	Driver Breath Test: Negati	Driver Age: 18
Veh Ref: 1	Location: Carw	Object in Cway: None	From: Se	Hit and Run: Nothtrun	
Veh Type: Car+3whl	Junction: Approach	Object off Cway None	To: Sw	Driver Gender: Male	
Foreign Veh: Notfrv	Towing; None	velcwy No	J Purpose: Other	Driver Severity: Slight	

Acc Ref:	Manoeuvre: Waitrigh	Skidding: None	Impact Point: Back	Driver Breath Test: Negati	Driver Age: 33
Veh Ref: 2	Location: Carw	Object in Cway: None	From: Se	Hit and Run: Nothtrun	
Veh Type: Car+3whl	Junction: Approach	Object off Cway None	To: N	Driver Gender: Female	
Foreign Veh: Notfrv	Towing; None	velcwy No	J Purpose: Other	Driver Severity: None	





Foot/cycle link to school / community facilities.

Proposed signal controlled crossing

3.5m wide foot/cycleway

Existing footpath

4.5m x 90m VS

PROPOSED 6.75M WIDE SITE ACCESS ROAD

126.5m

2m footway

Possible Right Turning Lane Junction

4.5m x 90m VS

Adventure Playground

3.5m wide foot/cycleway

Rev	Description	Date	Drawn	Checked
A	Amendments to access road width	11.04.12	LAF	DGS

stomor
CIVIL ENGINEERING CONSULTANTS

Registered Office:
32 Beehive Lane, Welwyn Garden City,
Hertfordshire, AL7 4BQ

Design Office:
19 Welworth Road, Hitchin, Herts, SG4 9SP
Tel: 01462 615433 Fax: 01462 615425
Email: info@stomor.com www.stomor.com

Project
Land at Fields End, Hemel Hempstead

Drawing Description
Possible Right Turn Facility Access on Long Chaulden

Scale	Date	Drawn By	Checked By
1:500	9.6.11	DGS	NJM

Client	Architect
--------	-----------

Notes
Do not scale off the drawing.
Only written dimensions should be taken.
Any discrepancies or errors should be brought to the attention of the engineer immediately.

Drawing Number
ST-2189-1-A

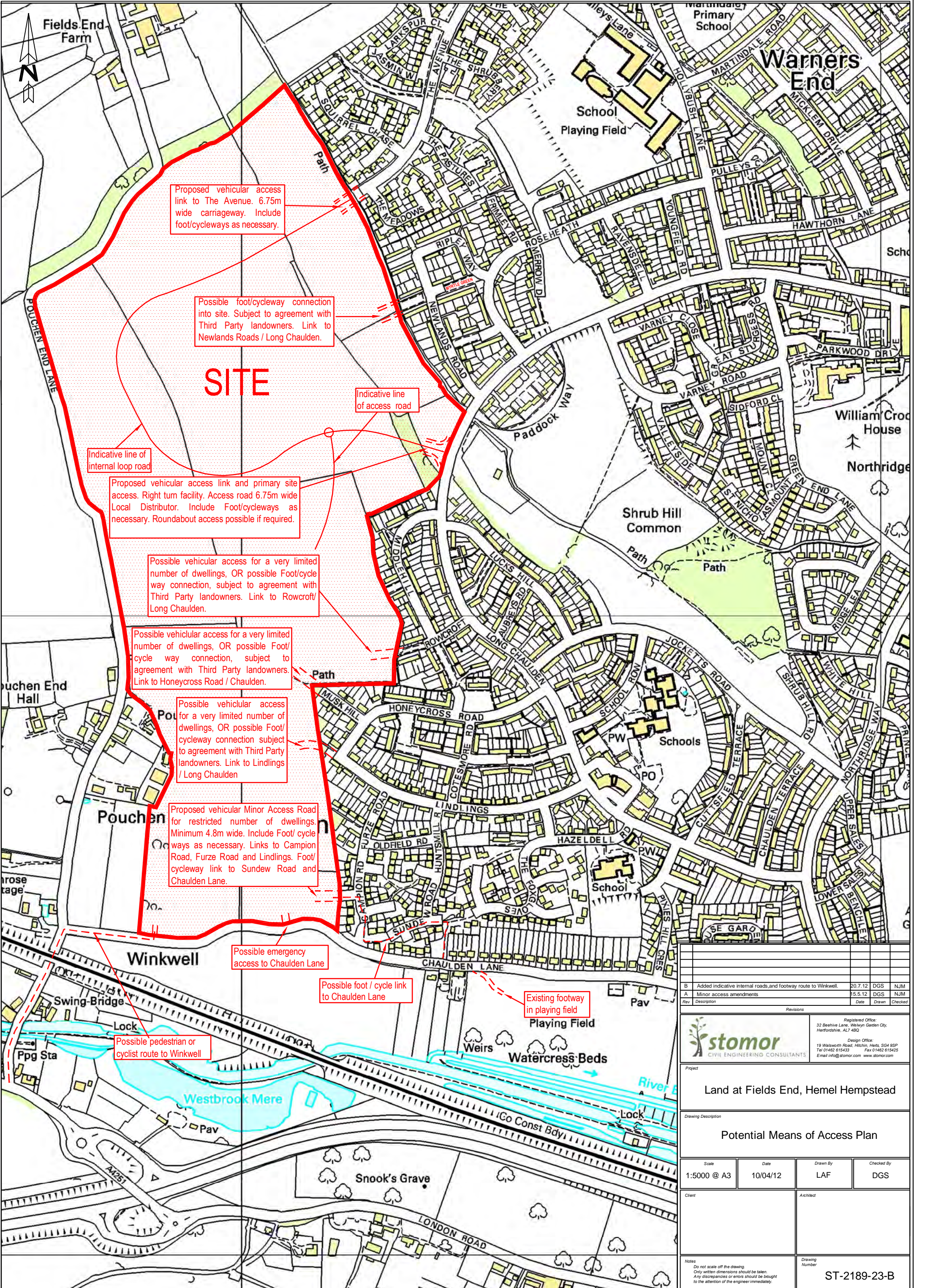

Rev	Description	Date	Drawn	Checked
B	Added indicative internal roads, and footway route to Winkwell.	20.7.12	DGS	NJM
A	Minor access amendments	15.5.12	DGS	NJM

		Registered Office: 32 Beehive Lane, Welwyn Garden City, Hertfordshire, AL7 4BQ	
		Design Office: 19 Welworth Road, Hitchin, Herts, SG4 9SP Tel 01462 615433 Fax 01462 615425 Email info@stomor.com www.stomor.com	

Project	Land at Fields End, Hemel Hempstead		
Drawing Description	Potential Means of Access Plan		
Scale	Date	Drawn By	Checked By
1:5000 @ A3	10/04/12	LAF	DGS
Client	Architect		
Notes	Drawing Number		
Do not scale off the drawing. Only written dimensions should be taken. Any discrepancies or errors should be brought to the attention of the engineer immediately.	ST-2189-23-B		



James Dale
Environment Department
Hertfordshire County Council
County Hall,
Pegs Lane,
Hertford,
SG13 8DN

22nd March 2012

Dear James,

**Land at Fields End, West of Hemel Hempstead, Herts
Means of Access and Traffic Appraisal for Core Strategy Submission**

Thank you for meeting with me at short notice at County Hall on 12th March 2012, in connection with the above site.

As discussed, we have been commissioned by Clients to prepare a Means of Access and Traffic Appraisal in support of their submission. Please find attached a copy of drawing number 4107 301 prepared by Vincent and Gorbing, which shows the land in question, with ownership information.

It is the intention to prepare our appraisal based on the following development scenario:-

- Provision of approximately 900 residential dwellings.
- Provision of a 2fe Primary School
- Small doctors surgery
- Community use area

In order to carry out the above assessment, the purpose of this meeting was to discuss your requirements and agree a scope for the work necessary.

With respect to access arrangements, I confirm that we will be seeking to maximise the potential traffic distribution arising from the site uses to minimise concentration of traffic on the surrounding road network, and to this end we will investigate several potential access locations. As discussed, it

is clear that the primary means of vehicular access will be taken from a new junction at Long Chaulden, with a further access being provided from the end of The Avenue. Due regard will be given to the road hierarchy when proposing the internal road arrangement for the development. It may be that measures will be taken within the site in order to control the proportion of traffic which uses these two access points. We will also consider a vehicular connection from the HCC owned land to the south. Further access points will be considered from residential areas to the east, and possibly to the south. These may be suitable for limited development, or cycle/ pedestrian/ emergency routes depending on the outcome of our investigations.

With respect to the junctions you would expect to see considered and assessed, these are listed below:-

- a. Long Chaulden between Newlands Road and Middlehill for the AM and PM peak periods.
- b. Long Chaulden junction with Boxted Road for the AM and PM peak periods.
- c. Warners End Road junction with Northridge Way for the AM and PM peak periods.
- d. Leighton Buzzard Road roundabout junction with Warners End Road for the AM and PM peak periods.
- e. Long Chaulden junction with Northridge Way for the AM and PM peak periods.
- f. The Avenue/Boxted Road for the AM and PM peak periods.

It may be that as development proposals proceed towards detailed planning applications in due course, further junctions may be identified, and these will be considered at the appropriate time. As agreed, we would not be expected to assess the Plough Roundabout at this stage.

With regard to the proposed school, we intend to site this in a suitable location within the development area, in order to maximise its sustainability. We would also seek to maximise potential footway and cycle links both within the site and to surrounding areas.

We have reviewed the previous reports prepared in connection with vehicle trip generation at this site, and have noted the following previously proposed rates as follows:-

AM 8:00am- :00am

PM 5:00pm-6:00pm

	Arrivals	Departures	Two Way	Arrivals	Departures	Two Way
Dennis Wilson 2000	-	-	0.57	-	-	0.58
HCC 2000	-	-	0.95	-	-	0.94
WSP 2006	0.13	0.5	0.63	0.42	0.21	0.63

HCC Hemel Hempstead Urban Transport Model 2010	0.262	0.641	0.903	0.658	0.354	1.012
---------------------------------------------------------	-------	-------	-------	-------	-------	-------

It can be seen that there is a variation in rates which have been proposed in the past, but we would be seeking to keep these to a sensible minimum by actively encouraging and maximising sustainable transport modes as part of our proposals. Inspection of the TRICS database indicates the following trip rates for residential use as follows:-

AM 8:00am- :00am

PM 5:00pm-6:00pm

Arrivals	Departures	Two Way	Arrivals	Departures	Two Way
0.161	0.422	0.583	0.393	0.236	0.629

In the light of the above, we would propose that for our assessment, we would use the following average residential trip rates:-

AM 8:00am- :00am

PM 5:00pm-6:00pm

Arrivals	Departures	Two Way	Arrivals	Departures	Two Way
0.2	0.5	0.7	0.4	0.25	0.65

We would be grateful if you could confirm that these trip rates are acceptable for the analysis we intend to carry out.

We have had an initial discussion with Sue Jackson as you suggested, and at this stage would not envisage a HHUT model re run for the purposes of our assessment, as this would only factor in our development and not the entire Hemel Hempstead scenario. However, we could provide you with our trip data if it would be of assistance for inclusion in subsequent model runs if you require.

We have noted that the Highways Agency have made representations to Dacorum BC on the pre – submission core strategy regarding possible effects of our development on Junction 20 of the M25. We intend to carry out liaison with them shortly to initiate discussions in this regard, to determine their requirements.

I trust the above is acceptable, and I look forward to your response at your earliest convenience.

Yours sincerely,

Duncan Stoten BSc CEng MICE MCIHT
Director

cc Mark Wilson – Vincent and Goring

Duncan Stoten

From: James Dale [james.dale@hertscc.gov.uk]
Sent: 13 June 2012 23:01
To: Duncan Stoten
Subject: RE: Land at Fields End Farm, Hemel Hempstead

Duncan

I'm sorry I thought I had replied to you.

Thank you for the letter (22 March 2012), at this stage it appears the main point is to reach an agreement on the trip rate. On this issue I can confirm the trip rate you have put forward in your letter is acceptable to the highway authority.

We have discussed the principle of an appropriate access layout at length. You have made reference to several broad locations and I look forward to seeing more detail on this.

Regarding testing existing junctions further afield. As you aware, it is difficult to predict which junctions will require further capacity testing without knowing how much of a development is going to be served from which access. As you state in your letter, as the details of the proposal come forward the scoping can be discussed in more detail.

James

From: Duncan Stoten [<mailto:Duncan@stomor.com>]
Sent: 13 June 2012 16:08
To: james.dale@hertfordshire.gov.uk
Cc: James Dale
Subject: Land at Fields End Farm, Hemel Hempstead

James

Further to my letter dated 22nd March 2012, and recent email forwarded by Matt Wood, I do not seem to have received a response to date.

I would be grateful if you could confirm that the parameters proposed are acceptable as soon as possible, as I have had to progress with the Means of Access, Transport and Sustainability report.

Thank you for your assistance.

Duncan Stoten

Duncan Stoten BSc CEng MICE MIHT
Director
email duncan@stomor.com





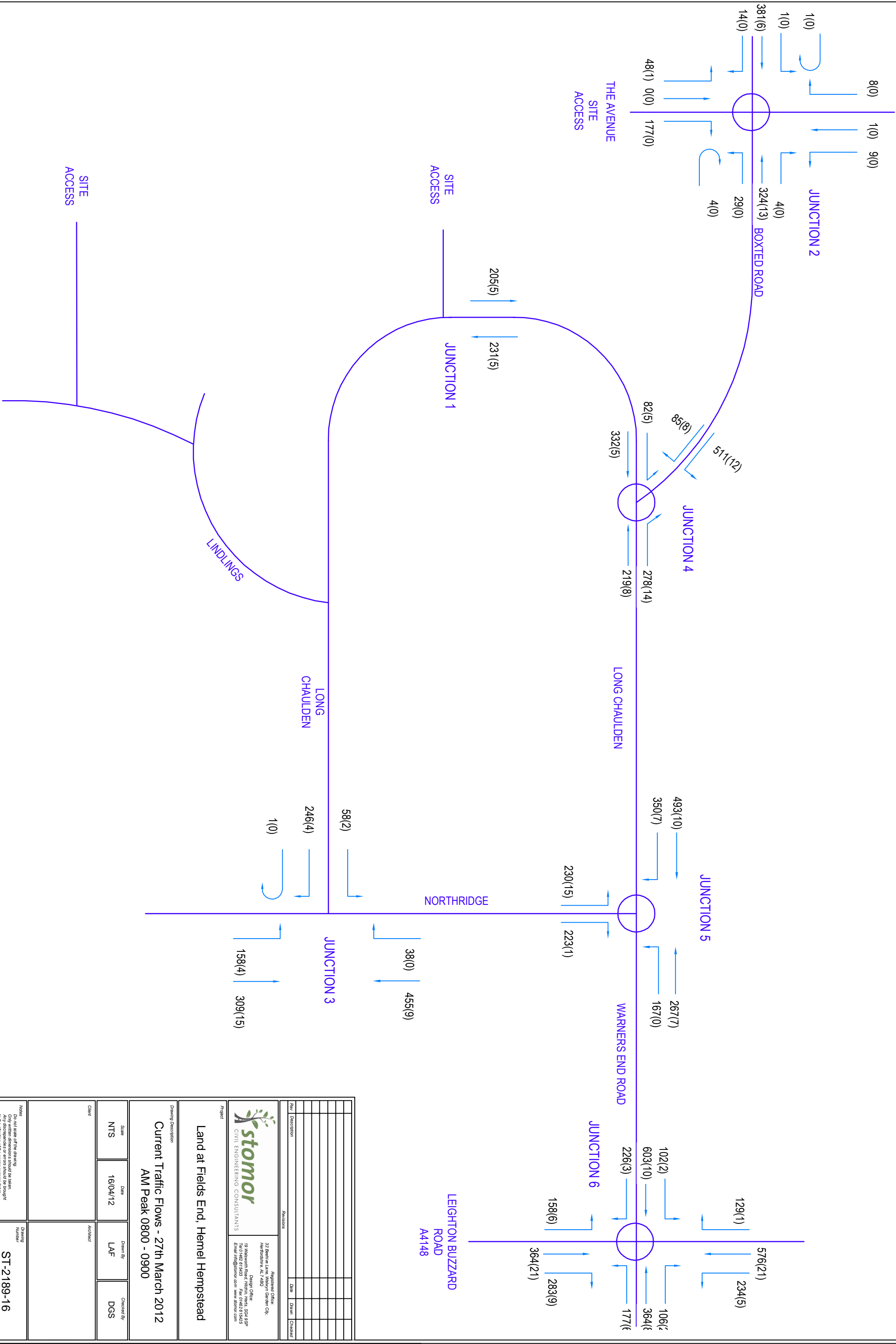

Rev	Description	Date	Drawn	Checked

stomor
 CIVIL ENGINEERING CONSULTANTS

Registered Office:
 32 Bevine Lane, Warners Green, Cny,
 Hemel Hempstead, AL2 4BP

Design Office:
 19 Millbrook Road, Hemel Hempstead, AL2 5AG
 Tel: 0462 614520
 Email: info@stomor.com www.stomor.com

Project: Land at Fields End, Hemel Hempstead

Drawing Description: Current Traffic Flows - 27th March 2012
 AM Peak 0800 - 0900

Scale	Date	Drawn By	Checked By
NTS	16/04/12	LAF	DGS
Client		Architect	

Notes	Drawing Number
Do not scale off the drawing. Only written dimensions should be taken. Any discrepancies or errors should be brought to the attention of the Engineer immediately.	ST-2189-16

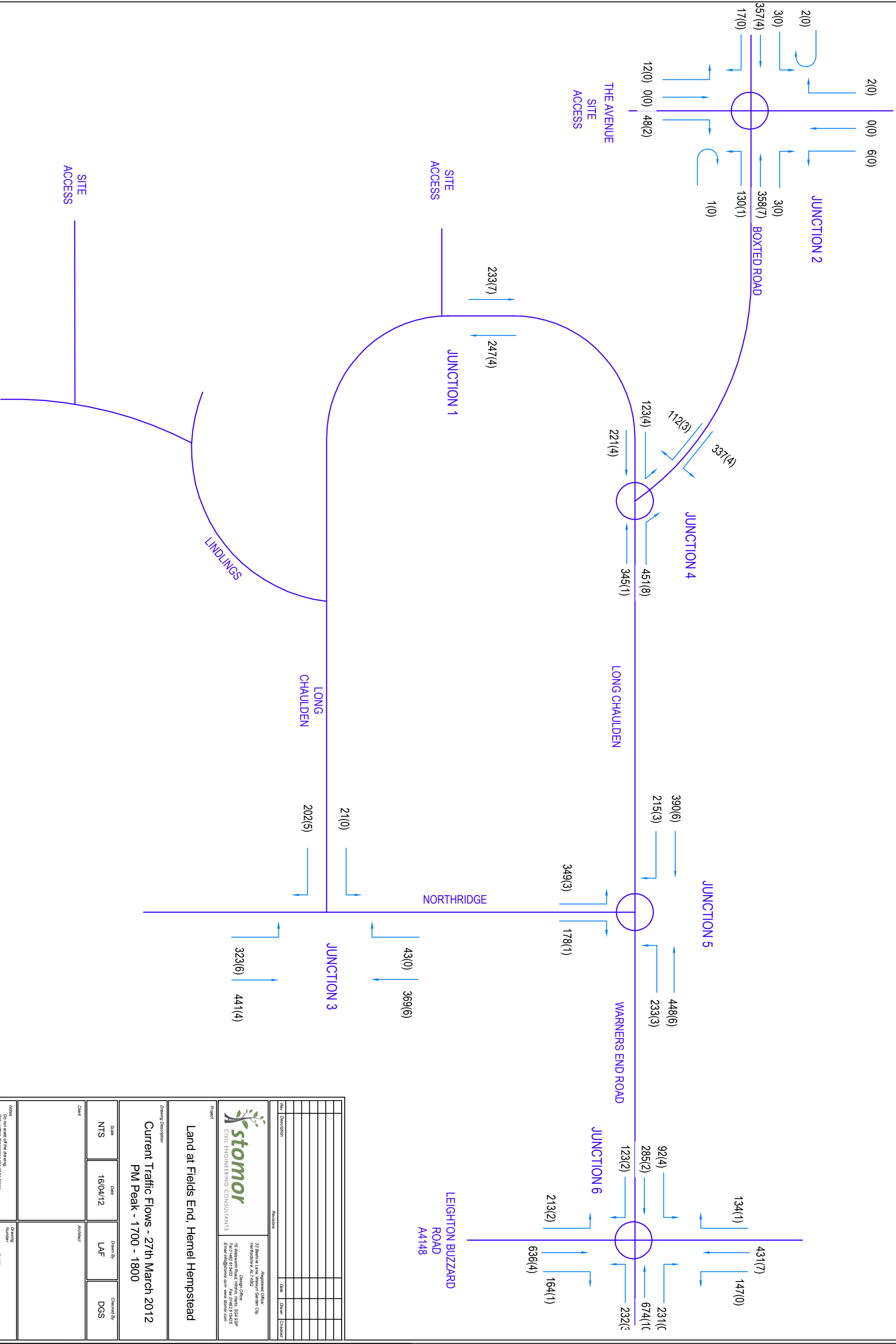

stomor
 CIVIL ENGINEERING CONSULTANTS

Registered Office:
 32 Bevine Lane, Warners Green, Cny,
 Northridge, AL 7 49D

Design Office:
 49 Melbourn Road, Piton, Ormskirk, Lancashire,
 Tel: 01694 614520
 Email: info@stomor.com www.stomor.com

Project: Land at Fields End, Hemel Hempstead

Drawing Description: Current Traffic Flows - 27th March 2012
 PM Peak - 1700 - 1800

Scale: NTS	Date: 16/04/12	Drawn By: LAF	Checked By: DGS
Client:		Architect:	

Revision Table:

Rev	Description	Date	Drawn	Checked

Notes:
 Do not scale of this drawing.
 Only written dimensions should be taken.
 Any discrepancies or errors should be brought
 to the attention of the signifier immediately.

Drawing Number: ST-2189-17

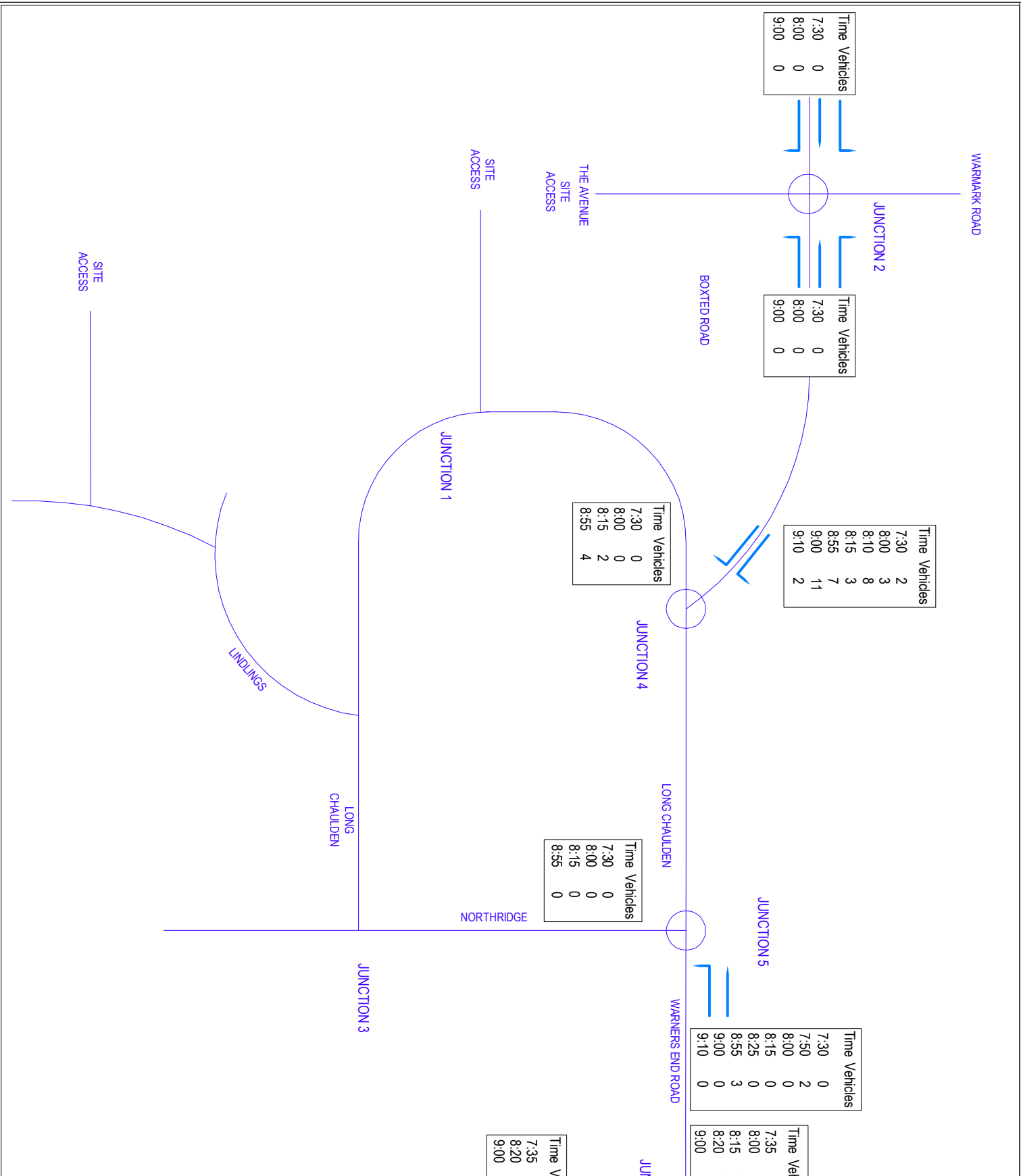

Traffic Queues
Peak AM Period

Time Vehicles	7:35	0
	7:50	8
	8:00	6
	8:05	7
	8:20	40-50
	9:00	10

Time Vehicle	7:10	0
	7:35	3
	8:20	0
	9:00	0

Time Vehicles	7:35	0
	8:00	3
	8:15	10
	8:20	12
	9:00	0

Time Vehicles	7:35	0
	8:20	0
	9:00	0

Time Vehicles	7:30	0
	7:50	2
	8:00	0
	8:15	0
	8:25	0
	8:55	3
	9:00	0
	9:10	0

Time Vehicles	7:35	0
	8:00	3
	8:15	10
	8:20	12
	9:00	0

Time Vehicles	7:30	0
	8:00	0
	8:15	0
	8:55	0

Time Vehicles	7:35	0
	8:20	0
	9:00	0

Time Vehicles	7:30	2
	8:00	3
	8:10	8
	8:15	3
	8:55	7
	9:00	11
	9:10	2

Time Vehicles	7:30	0
	8:00	0
	8:15	2
	8:55	4

Time Vehicles	7:30	0
	8:00	0
	8:15	2
	8:55	4

Time Vehicles	7:30	0
	8:00	0
	9:00	0

Time Vehicles	7:30	0
	8:00	0
	9:00	0

 <p>stomor CIVIL ENGINEERING CONSULTANTS</p>		<p>28 Marlborough Road, Hemel Hempstead, Herts, AL2 9JQ Tel: 01462 47422 Fax: 01462 47423 20 Southgate Road, Hemel Hempstead, Herts, AL2 9JQ Tel: 01462 47422 Fax: 01462 47423 Email: info@stomor.co.uk</p>	
<p>Project: Land at Fields End, Hemel Hempstead</p>		<p>Author: [Blank]</p>	
<p>Design Description: Existing Traffic Queues AM 27th and 28th March 2012</p>		<p>Checked By: [Blank]</p>	
Scale: NTS	Date: 10/05/12	Drawn By: LAF	Checked By: DGS
Client: [Blank]	Approved: [Blank]	Drawing Number: ST-2189-28	
<p>Notes: 1. This drawing is for the use of the client only. 2. It is not to be used for any other purpose without the written consent of Stomor. 3. The client is responsible for the accuracy of the information provided to Stomor. 4. Stomor is not responsible for the accuracy of the information provided to the client.</p>			



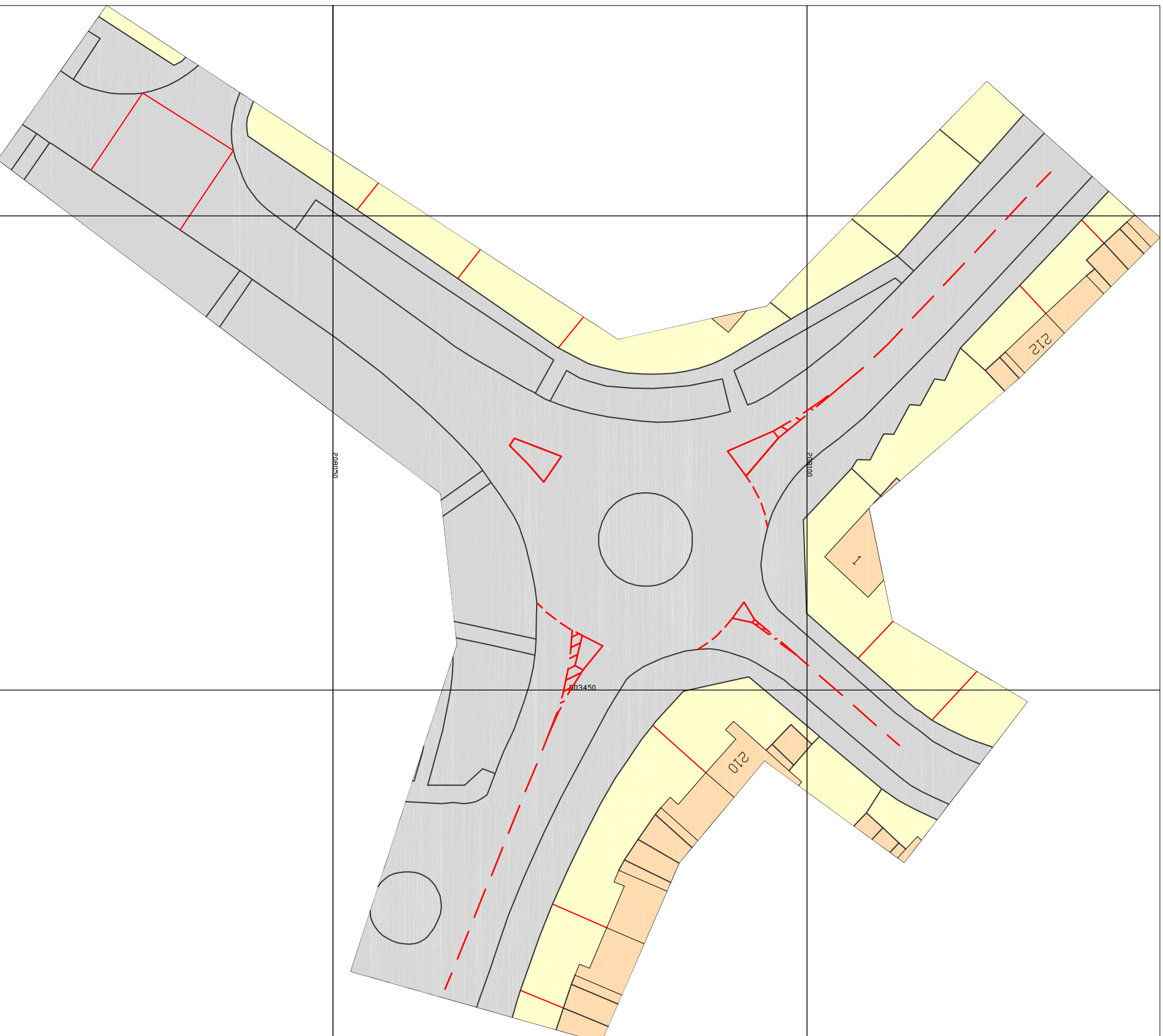
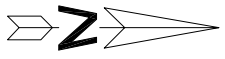

Ordinance Survey, (c) Crown Copyright 2012. All rights reserved. Licence number

Rev	Description	Date	Drawn	Checked

stomor
CIVIL ENGINEERING CONSULTANTS

Registered Office:
32 Bevine Lane, Walsley, Oldham, Chx,
West Yorkshire, AL7 4BP

Design Office:
19 Millbank Road, Farnham, Surrey, GU14 5PP
Tel: 01252 614520
Email: info@stomor.com www.stomor.com

Project: **Land at Fields End, Hemel Hempstead**

Drawing Description:
**Roundabout Junction Between Boxed Road
and The Avenue**

Scale	Date	Drawn By	Checked By
1:500	12/04/12	LAF	DGS
Client	Architect		

Notes:
Do not scale of the drawing.
Only written dimensions should be taken.
Any discrepancies or errors should be brought
to the attention of the Engineer immediately.

Drawing Number: **ST-2189-24**

ARCADY 7

Version: 7.0.0.99 [10 July 2009]

© Copyright Transport Research Laboratory 2009

For sales and distribution information, program advice and maintenance, contact TRL:
Tel: +44 (0)1344 770758 E-mail: software@trl.co.uk Web: www.trlsoftware.co.uk

The users of this computer program for the solution of an engineering problem are in no way relieved of their responsibility for the correctness of the solution

File: Z:\Stomor Ltd\2100 Projects\2189-Hemel Hempstead- Land at Fields End\ARCADY\Junction 2\Junction 2-2012-existing-AM.arc7
Report generation date: 22/05/2012 15:57:39

File summary

File Description

Title	Boxted Road/The Avenue Roundabout
Location	Hemel Hempstead
Site Number	ST-2189
Date	10/05/2012
Status	(new file)
Client	Taylor Wiompey Strategic Land
Jobnumber	ST-2189
Enumerator	STOMORLTD\duncan
Description	AM Peak Hour 2012 - Existing.
Results Upto Date	True

Analysis Options

RFC Threshold	Vehicle Length (m)	Do Queue Variations
0.85	5.75	

Sorting and Display

Show Arm Names	Arm Grouping	Sorting Direction	Sorting Type	Data Matrix Style	Time Style
Yes	Order	Ascending	Numerical	By Destination	Absolute Time

Units

Distance Units	Speed Units	Traffic Units Input	Traffic Units Results	Flow Units	Average Delay Units	Total Delay Units	Rate Of Delay Units
m	kph	Veh	Veh	perHour	min	-Min	perMin

A2 - (Default Analysis Set) - D1 - Existing 2012, AM 0800 - 0 00

Data Errors and Warnings

No errors or warnings

Analysis Set Details

Name	Description	Include In Report	Use Specific Demand Set	Demand Set	Locked	Network Flow Scaling Factor (%)	Network Capacity Scaling Factor (%)	Reason For Scaling Factors
(Default Analysis Set)		Yes		(D1)		100.000	100.000	

Demand Set Details

Name	Scenario Name	Time Period Name	Description	Locked	Run Automatically	Use Relationship	Relationship	Start Time (HH:mm)	Finish Time (HH:mm)	Time Period Length	Time Segment Length	Traffic Profile Type
------	---------------	------------------	-------------	--------	-------------------	------------------	--------------	--------------------	---------------------	--------------------	---------------------	----------------------

Existing 2012, AM 0800 - 0900	Existing 2012	AM 0800 - 0900	Peak Hour Flows		Yes			07:45	09:15	90	15	ONE HOUR
-------------------------------	---------------	----------------	-----------------	--	-----	--	--	-------	-------	----	----	----------

Roundabout Network

Roundabout Type(s)

ID	Name	Arm Order	Roundabout Type	Grade Separated	Large Roundabout	Do Geometric Delay
1	Boxted Road/The Avenue Roundabout	1,2,3,4	Standard			

Roundabout Network Options

Driving Side	Lighting	Road Surface	In London
Left	Normal/unknown	((Mini-roundabouts only))	

Arms

Arms

ID	Name	Description
1	Boxted Road North	Single Carriageway
2	Warmark Road	Single Carriageway
3	Boxted Road South	Single Carriageway
4	The Avenue	Single Carriageway

Capacity Options

Arm	Minimum Capacity (PCU/hr)	Maximum Capacity (PCU/hr)	Assume Flat Start Profile	Initial Queue (PCU)
Boxted Road North	0.00	99999.00		0.00
Warmark Road	0.00	99999.00		0.00
Boxted Road South	0.00	99999.00		0.00
The Avenue	0.00	99999.00		0.00

Standard Geometry

Arm	V - Approach road half-width (m)	E - Entry width (m)	I' - Effective flare length (m)	R - Entry radius (m)	D - Inscribed circle diameter (m)	PHI - Conflict (entry) angle (deg)	Exit Only
Boxted Road North	3.40	5.00	6.00	10.00	24.00	31.00	
Warmark Road	2.50	3.80	3.50	13.50	24.50	27.50	
Boxted Road South	3.50	4.50	9.00	20.00	24.00	19.00	
The Avenue	3.45	5.10	12.00	29.00	24.50	17.00	

Pedestrian Crossings

Arm	Crossing Type
Boxted Road North	None
Warmark Road	None
Boxted Road South	None
The Avenue	None

Arm Slope/ Intercept and Capacity

Slope and Intercept used in model

Arm	Enter Directly	Slope	Intercept (PCU/hr)	Final Slope	Final Intercept (PCU/hr)
Boxted Road North		((calculated))	((calculated))	0.548	1224.132
Warmark Road		((calculated))	((calculated))	0.498	923.541
Boxted Road South		((calculated))	((calculated))	0.599	1333.036
The Avenue		((calculated))	((calculated))	0.635	1476.488

The slope and intercept shown above include any corrections and adjustments.

Traffic Flows

Demand Set Data Options

Default Vehicle Mix	Vehicle Mix Varies Over Time	Vehicle Mix Varies Over Turn	Vehicle Mix Varies Over Entry	Vehicle Mix Source	PCU Factor for a HV (PCU)	Default Turning Proportions	Estimate from entry/exit counts	Turning Proportions Vary Over Time	Turning Proportions Vary Over Turn	Turning Proportions Vary Over Entry
	Yes	Yes	Yes	HV Percentages	2.00				Yes	Yes

Entry Flows

General Flows Data

Arm	Profile Type	Use Turning Counts	Average Demand Flow (Veh/hr)	Flow Scaling Factor (%)	PHF
Boxted Road North	ONE HOUR	Yes	396.00	100.000	N/A
Warmark Road	ONE HOUR	Yes	18.00	100.000	N/A
Boxted Road South	ONE HOUR	Yes	357.00	100.000	N/A
The Avenue	ONE HOUR	Yes	225.00	100.000	N/A

Direct/Resultant Flows

Direct Flows Data

Time Segment	Arm	Direct Demand Entry Flow (Veh/hr)	DirectDemandEntryFlowInPCU (PCU/hr)	Direct Demand Exit Flow (Veh/hr)	Direct Demand Pedestrian Flow (Ped/hr)
07:45-08:00	Boxted Road North	298.13	302.63	N/A	N/A
07:45-08:00	Warmark Road	13.55	13.55	N/A	N/A
07:45-08:00	Boxted Road South	268.77	278.53	N/A	N/A
07:45-08:00	The Avenue	169.39	170.15	N/A	N/A
08:00-08:15	Boxted Road North	356.00	377.96	N/A	N/A
08:00-08:15	Warmark Road	16.18	18.05	N/A	N/A
08:00-08:15	Boxted Road South	320.94	369.68	N/A	N/A
08:00-08:15	The Avenue	202.27	220.20	N/A	N/A
08:15-08:30	Boxted Road North	436.00	462.91	N/A	N/A
08:15-08:30	Warmark Road	19.82	22.11	N/A	N/A
08:15-08:30	Boxted Road South	393.06	452.77	N/A	N/A
08:15-08:30	The Avenue	247.73	269.68	N/A	N/A
08:30-08:45	Boxted Road North	436.00	462.91	N/A	N/A
08:30-08:45	Warmark Road	19.82	22.11	N/A	N/A
08:30-08:45	Boxted Road South	393.06	452.77	N/A	N/A
08:30-08:45	The Avenue	247.73	269.68	N/A	N/A
08:45-0 :00	Boxted Road North	356.00	374.25	N/A	N/A
08:45-0 :00	Warmark Road	16.18	16.99	N/A	N/A
08:45-0 :00	Boxted Road South	320.94	336.98	N/A	N/A
08:45-0 :00	The Avenue	202.27	212.38	N/A	N/A
0 :00-0 :15	Boxted Road North	298.13	313.41	N/A	N/A
0 :00-0 :15	Warmark Road	13.55	14.23	N/A	N/A
0 :00-0 :15	Boxted Road South	268.77	282.21	N/A	N/A
0 :00-0 :15	The Avenue	169.39	177.86	N/A	N/A

Turning Proportions

Turning Counts or Proportions (Veh/hr) - Roundabout 1 (for whole period)

		To			
		1	2	3	4
1	0.00	1.00	381.00	14.00	

	2	8.00	0.00	9.00	1.00
From	3	324.00	4.00	0.00	29.00
	4	48.00	0.00	177.00	0.00

Turning Proportions (Veh) - Roundabout 1 (for whole period)

		To			
		1	2	3	4
From	1	0.00	0.00	0.96	0.04
	2	0.44	0.00	0.50	0.06
	3	0.91	0.01	0.00	0.08
	4	0.21	0.00	0.79	0.00

Vehicle Mix

Average PCU Per Vehicle - Roundabout 1 - (07:45-08:00)

		To			
		1	2	3	4
From	1	1.00	1.00	1.02	1.00
	2	1.00	1.00	1.00	1.00
	3	1.04	1.00	1.00	1.00
	4	1.02	1.00	1.00	1.00

Heavy Vehicle Percentages - Roundabout 1 - (07:45-08:00)

		To			
		1	2	3	4
From	1	0.00	0.00	1.57	0.00
	2	0.00	0.00	0.00	0.00
	3	4.00	0.00	0.00	0.00
	4	2.10	0.00	0.00	0.00

Average PCU Per Vehicle - Roundabout 1 - (08:00-08:15)

		To			
		1	2	3	4
From	1	1.00	1.00	1.06	1.04
	2	1.09	1.00	1.15	1.03
	3	1.15	1.00	1.00	1.19
	4	1.08	1.00	1.09	1.00

Heavy Vehicle Percentages - Roundabout 1 - (08:00-08:15)

		To			
		1	2	3	4
From	1	0.00	0.00	6.25	4.45
	2	8.85	0.00	15.00	2.50
	3	15.00	0.00	0.00	19.40
	4	7.69	0.00	9.18	0.00

Average PCU Per Vehicle - Roundabout 1 - (08:15-08:30)

		To			
		1	2	3	4
From	1	1.00	1.00	1.06	1.04
	2	1.09	1.00	1.15	1.03
	3	1.15	1.00	1.00	1.19
	4	1.08	1.00	1.09	1.00

Heavy Vehicle Percentages - Roundabout 1 - (08:15-08:30)

		To			
		1	2	3	4
	1	0.00	0.00	6.25	4.45

From	2	8.85	0.00	15.00	2.50
	3	15.00	0.00	0.00	19.40
	4	7.69	0.00	9.18	0.00

Average PCU Per Vehicle - Roundabout 1 - (08:30-08:45)

From	To				
		1	2	3	4
	1	1.00	1.00	1.06	1.04
	2	1.09	1.00	1.15	1.03
	3	1.15	1.00	1.00	1.19
4	1.08	1.00	1.09	1.00	

Heavy Vehicle Percentages - Roundabout 1 - (08:30-08:45)

From	To				
		1	2	3	4
	1	0.00	0.00	6.25	4.45
	2	8.85	0.00	15.00	2.50
	3	15.00	0.00	0.00	19.40
4	7.69	0.00	9.18	0.00	

Average PCU Per Vehicle - Roundabout 1 - (08:45-0 :00)

From	To				
		1	2	3	4
	1	1.00	1.55	1.05	1.05
	2	1.05	1.00	1.05	1.05
	3	1.05	1.05	1.00	1.05
4	1.05	1.05	1.05	1.00	

Heavy Vehicle Percentages - Roundabout 1 - (08:45-0 :00)

From	To				
		1	2	3	4
	1	0.00	55.00	5.00	5.00
	2	5.00	0.00	5.00	5.00
	3	5.00	5.00	0.00	5.00
4	5.00	5.00	5.00	0.00	

Average PCU Per Vehicle - Roundabout 1 - (0 :00-0 :15)

From	To				
		1	2	3	4
	1	1.00	1.55	1.05	1.05
	2	1.05	1.00	1.05	1.05
	3	1.05	1.05	1.00	1.05
4	1.05	1.05	1.05	1.00	

Heavy Vehicle Percentages - Roundabout 1 - (0 :00-0 :15)

From	To				
		1	2	3	4
	1	0.00	55.00	5.00	5.00
	2	5.00	0.00	5.00	5.00
	3	5.00	5.00	0.00	5.00
4	5.00	5.00	5.00	0.00	

Results

Results Summary

Arm	Max RFC	Max Delay (min)	Max Queue (Veh)	Max LOS	Total Demand (Veh/hr)	Total Arrivals (Veh)	Total Queueing Delay (Veh-min)	Average Queueing Delay (min)	Rate Of Queueing Delay (Veh-	Inclusive Queueing Total Delay	Inclusive Queueing Average Delay	Slope	Intercept (PCU/hr)
-----	---------	-----------------	-----------------	---------	-----------------------	----------------------	--------------------------------	------------------------------	------------------------------	--------------------------------	----------------------------------	-------	--------------------

									min/min)	(Veh-min)	(min)		
Boxted Road North	0.42	0.10	0.72	A	363.30	544.96	47.18	0.09	0.52	47.18	0.09	0.548	1224.132
Warmark Road	0.04	0.12	0.04	A	16.49	24.74	2.59	0.10	0.03	2.59	0.10	0.498	923.541
Boxted Road South	0.34	0.08	0.54	A	326.83	490.24	34.55	0.07	0.38	34.55	0.07	0.599	1333.036
The Avenue	0.22	0.07	0.29	A	206.30	309.46	19.32	0.06	0.21	19.32	0.06	0.635	1476.488

Main Results

Main results: (07:45-08:00)

Arm	Demand (Veh/hr)	Arrivals (Veh)	Entry Flow (Veh/hr)	Exit Flow (Veh/hr)	Circulating Flow (Veh/hr)	Pedestrian Demand (Ped/hr)	Capacity (Veh/hr)	Saturation Capacity (Veh/hr)	RFC	Start Queue (Veh)	End Queue (Veh)
Boxted Road North	298.13	74.53	296.71	284.96	135.79	0.00	1132.59	908.34	0.263	0.00	0.35
Warmark Road	13.55	3.39	13.47	3.75	428.75	0.00	707.94	198.30	0.019	0.00	0.02
Boxted Road South	268.77	67.19	267.71	424.99	17.23	0.00	1276.39	1210.49	0.211	0.00	0.27
The Avenue	169.39	42.35	168.80	32.98	251.95	0.00	1304.48	683.31	0.130	0.00	0.15

Main results: (08:00-08:15)

Arm	Demand (Veh/hr)	Arrivals (Veh)	Entry Flow (Veh/hr)	Exit Flow (Veh/hr)	Circulating Flow (Veh/hr)	Pedestrian Demand (Ped/hr)	Capacity (Veh/hr)	Saturation Capacity (Veh/hr)	RFC	Start Queue (Veh)	End Queue (Veh)
Boxted Road North	356.05	89.01	355.41	341.09	162.51	0.00	1061.75	865.16	0.335	0.34	0.50
Warmark Road	16.19	4.05	16.14	4.49	513.43	0.00	582.75	175.82	0.028	0.02	0.03
Boxted Road South	321.03	80.26	320.44	508.94	20.64	0.00	1146.24	1091.58	0.280	0.24	0.39
The Avenue	202.31	50.58	202.02	39.49	301.59	0.00	1154.85	635.33	0.175	0.14	0.21

Main results: (08:15-08:30)

Arm	Demand (Veh/hr)	Arrivals (Veh)	Entry Flow (Veh/hr)	Exit Flow (Veh/hr)	Circulating Flow (Veh/hr)	Pedestrian Demand (Ped/hr)	Capacity (Veh/hr)	Saturation Capacity (Veh/hr)	RFC	Start Queue (Veh)	End Queue (Veh)
Boxted Road North	436.00	109.00	435.15	417.82	199.04	0.00	1041.00	865.02	0.419	0.50	0.71
Warmark Road	19.82	4.95	19.78	5.50	628.70	0.00	527.38	175.74	0.038	0.03	0.04
Boxted Road South	393.07	98.27	392.53	623.21	25.27	0.00	1143.35	1091.25	0.344	0.39	0.52
The Avenue	247.73	61.93	247.43	48.37	369.43	0.00	1109.17	635.20	0.223	0.21	0.29

Main results: (08:30-08:45)

Arm	Demand (Veh/hr)	Arrivals (Veh)	Entry Flow (Veh/hr)	Exit Flow (Veh/hr)	Circulating Flow (Veh/hr)	Pedestrian Demand (Ped/hr)	Capacity (Veh/hr)	Saturation Capacity (Veh/hr)	RFC	Start Queue (Veh)	End Queue (Veh)
Boxted Road North	436.00	109.00	435.99	418.38	199.28	0.00	1040.86	865.02	0.419	0.71	0.72
Warmark Road	19.82	4.95	19.82	5.50	629.76	0.00	526.87	175.74	0.038	0.04	0.04
Boxted Road South	393.07	98.27	393.06	624.26	25.32	0.00	1143.32	1091.25	0.344	0.52	0.52
The Avenue	247.73	61.93	247.73	48.44	369.94	0.00	1108.83	635.20	0.223	0.29	0.29

Main results: (08:45-0 :00)

Arm	Demand (Veh/hr)	Arrivals (Veh)	Entry Flow (Veh/hr)	Exit Flow (Veh/hr)	Circulating Flow (Veh/hr)	Pedestrian Demand (Ped/hr)	Capacity (Veh/hr)	Saturation Capacity (Veh/hr)	RFC	Start Queue (Veh)	End Queue (Veh)
Boxted Road North	355.97	88.99	356.87	342.33	162.99	0.00	1075.10	874.52	0.331	0.72	0.50
Warmark Road	16.17	4.04	16.23	4.51	515.35	0.00	622.66	188.47	0.026	0.04	0.03
Boxted Road South	320.72	80.18	321.62	510.85	20.73	0.00	1256.28	1193.76	0.255	0.57	0.34
The Avenue	202.23	50.56	202.61	39.64	302.71	0.00	1213.56	655.85	0.167	0.30	0.20

Main results: (0 :00-0 :15)

Arm	Demand (Veh/hr)	Arrivals (Veh)	Entry Flow (Veh/hr)	Exit Flow (Veh/hr)	Circulating Flow (Veh/hr)	Pedestrian Demand (Ped/hr)	Capacity (Veh/hr)	Saturation Capacity (Veh/hr)	RFC	Start Queue (Veh)	End Queue (Veh)
Boxted Road North	298.13	74.53	298.61	286.39	136.40	0.00	1089.77	874.60	0.274	0.50	0.38
Warmark Road	13.55	3.39	13.58	3.77	431.24	0.00	664.95	188.59	0.020	0.03	0.02
Boxted Road South	268.77	67.19	269.06	427.48	17.34	0.00	1259.17	1194.57	0.213	0.34	0.27
The Avenue	169.39	42.35	169.56	33.17	253.23	0.00	1245.37	655.99	0.136	0.20	0.16

Queueing Delay Results

Queueing Delay results: (07:45-08:00)

Arm	Queueing Total Delay (Veh-min)	Queueing Rate Of Delay (Veh-min/min)	Average Delay Per Arriving Vehicle (min)	Unsignalised Level Of Service	Signalised Level Of Service
Boxted Road North	5.19	0.35	0.072	A	A
Warmark Road	0.28	0.02	0.086	A	A
Boxted Road South	3.90	0.26	0.059	A	A
The Avenue	2.19	0.15	0.053	A	A

Queueing Delay results: (08:00-08:15)

Arm	Queueing Total Delay (Veh-min)	Queueing Rate Of Delay (Veh-min/min)	Average Delay Per Arriving Vehicle (min)	Unsignalised Level Of Service	Signalised Level Of Service
Boxted Road North	7.33	0.49	0.085	A	A
Warmark Road	0.42	0.03	0.106	A	A
Boxted Road South	5.68	0.38	0.073	A	A
The Avenue	3.12	0.21	0.063	A	A

Queueing Delay results: (08:15-08:30)

Arm	Queueing Total Delay (Veh-min)	Queueing Rate Of Delay (Veh-min/min)	Average Delay Per Arriving Vehicle (min)	Unsignalised Level Of Service	Signalised Level Of Service
Boxted Road North	10.40	0.69	0.099	A	A
Warmark Road	0.57	0.04	0.118	A	A
Boxted Road South	7.64	0.51	0.080	A	A
The Avenue	4.22	0.28	0.070	A	A

Queueing Delay results: (08:30-08:45)

Arm	Queueing Total Delay (Veh-min)	Queueing Rate Of Delay (Veh-min/min)	Average Delay Per Arriving Vehicle (min)	Unsignalised Level Of Service	Signalised Level Of Service
Boxted Road North	10.73	0.72	0.099	A	A
Warmark Road	0.58	0.04	0.118	A	A
Boxted Road South	7.82	0.52	0.080	A	A
The Avenue	4.30	0.29	0.070	A	A

Queueing Delay results: (08:45-0 :00)

Arm	Queueing Total Delay (Veh-min)	Queueing Rate Of Delay (Veh-min/min)	Average Delay Per Arriving Vehicle (min)	Unsignalised Level Of Service	Signalised Level Of Service
Boxted Road North	7.67	0.51	0.084	A	A
Warmark Road	0.41	0.03	0.099	A	A
Boxted Road South	5.28	0.35	0.064	A	A
The Avenue	3.07	0.20	0.059	A	A

Queueing Delay results: (0 :00-0 :15)

Arm	Queueing Total Delay (Veh-min)	Queueing Rate Of Delay (Veh-min/min)	Average Delay Per Arriving Vehicle (min)	Unsignalised Level Of Service	Signalised Level Of Service
Boxted Road North	5.80	0.39	0.076	A	A
Warmark Road	0.32	0.02	0.092	A	A
Boxted Road South	4.15	0.28	0.061	A	A
The Avenue	2.40	0.16	0.056	A	A

Overview: Standard Roundabout Geometry

Standard Geometry

Arm	V - Approach road half-width (m)	E - Entry width (m)	I' - Effective flare length (m)	R - Entry radius (m)	D - Inscribed circle diameter (m)	PHI - Conflict (entry) angle (deg)	Exit Only	Final Slope	Final Intercept (PCU/hr)
Boxted Road North	3.40	5.00	6.00	10.00	24.00	31.00		0.548	1224.132
Warmark Road	2.50	3.80	3.50	13.50	24.50	27.50		0.498	923.541
Boxted Road South	3.50	4.50	9.00	20.00	24.00	19.00		0.599	1333.036
The Avenue	3.45	5.10	12.00	29.00	24.50	17.00		0.635	1476.488

Overview: Time Segment Results

Time Segment Results

Time Segment	Arm	Demand (Veh/hr)	Capacity (Veh/hr)	RFC	Pedestrian Demand (Ped/hr)	Start Queue (Veh)	End Queue (Veh)	Queueing Total Delay (Veh-min)	Geometric Total Delay (Veh-min)	Average Delay Per Arriving Vehicle (min)
07:45-08:00	Boxted Road North	298.13	1132.59	0.263	0.00	0.00	0.35	5.19	(16.21)	0.072
07:45-08:00	Warmark Road	13.55	707.94	0.019	0.00	0.00	0.02	0.28	(22.65)	0.086
07:45-08:00	Boxted Road South	268.77	1276.39	0.211	0.00	0.00	0.27	3.90	(18.18)	0.059
07:45-08:00	The Avenue	169.39	1304.48	0.130	0.00	0.00	0.15	2.19	(16.52)	0.053
08:00-08:15	Boxted Road North	356.05	1061.75	0.335	0.00	0.34	0.50	7.33	(15.51)	0.085
08:00-08:15	Warmark Road	16.19	582.75	0.028	0.00	0.02	0.03	0.42	(20.31)	0.106
08:00-08:15	Boxted Road South	321.03	1146.24	0.280	0.00	0.24	0.39	5.68	(16.36)	0.073
08:00-08:15	The Avenue	202.31	1154.85	0.175	0.00	0.14	0.21	3.12	(15.25)	0.063
08:15-08:30	Boxted Road North	436.00	1041.00	0.419	0.00	0.50	0.71	10.40	(15.50)	0.099
08:15-08:30	Warmark Road	19.82	527.38	0.038	0.00	0.03	0.04	0.57	(20.30)	0.118
08:15-08:30	Boxted Road South	393.07	1143.35	0.344	0.00	0.39	0.52	7.64	(16.36)	0.080
08:15-08:30	The Avenue	247.73	1109.17	0.223	0.00	0.21	0.29	4.22	(15.25)	0.070
08:30-08:45	Boxted Road North	436.00	1040.86	0.419	0.00	0.71	0.72	10.73	(15.50)	0.099
08:30-08:45	Warmark Road	19.82	526.87	0.038	0.00	0.04	0.04	0.58	(20.30)	0.118
08:30-08:45	Boxted Road South	393.07	1143.32	0.344	0.00	0.52	0.52	7.82	(16.36)	0.080
08:30-08:45	The Avenue	247.73	1108.83	0.223	0.00	0.29	0.29	4.30	(15.25)	0.070
08:45-0 :00	Boxted Road North	355.97	1075.10	0.331	0.00	0.72	0.50	7.67	(15.66)	0.084
08:45-0 :00	Warmark Road	16.17	622.66	0.026	0.00	0.04	0.03	0.41	(21.56)	0.099
08:45-0 :00	Boxted Road South	320.72	1256.28	0.255	0.00	0.57	0.34	5.28	(17.93)	0.064
08:45-0 :00	The Avenue	202.23	1213.56	0.167	0.00	0.30	0.20	3.07	(15.80)	0.059
0 :00-0 :15	Boxted Road North	298.13	1089.77	0.274	0.00	0.50	0.38	5.80	(15.66)	0.076
0 :00-0 :15	Warmark Road	13.55	664.95	0.020	0.00	0.03	0.02	0.32	(21.58)	0.092
0 :00-0 :15	Boxted Road South	268.77	1259.17	0.213	0.00	0.34	0.27	4.15	(17.95)	0.061
0 :00-0 :15	The Avenue	169.39	1245.37	0.136	0.00	0.20	0.16	2.40	(15.81)	0.056

ARCADY 7

Version: 7.0.0.99 [10 July 2009]

© Copyright Transport Research Laboratory 2009

For sales and distribution information, program advice and maintenance, contact TRL:
Tel: +44 (0)1344 770758 E-mail: software@trl.co.uk Web: www.trlsoftware.co.uk

The users of this computer program for the solution of an engineering problem are in no way relieved of their responsibility for the correctness of the solution

File: Z:\Stomor Ltd\2100 Projects\2189-Hemel Hempstead- Land at Fields End\ARCADY\Junction 2\Junction 2-2012-existing-PM.arc7
Report generation date: 22/05/2012 15:58:37

File summary

File Description

Title	Boxted Road/The Avenue Roundabout
Location	Hemel Hempstead
Site Number	ST-2189
Date	10/05/2012
Status	(new file)
Client	Taylor Wiompey Strategic Land
Jobnumber	ST-2189
Enumerator	STOMORLTD\duncan
Description	PM Peak Hour 2012 - Existing.
Results Upto Date	True

Analysis Options

RFC Threshold	Vehicle Length (m)	Do Queue Variations
0.85	5.75	

Sorting and Display

Show Arm Names	Arm Grouping	Sorting Direction	Sorting Type	Data Matrix Style	Time Style
Yes	Order	Ascending	Numerical	By Destination	Absolute Time

Units

Distance Units	Speed Units	Traffic Units Input	Traffic Units Results	Flow Units	Average Delay Units	Total Delay Units	Rate Of Delay Units
m	kph	Veh	Veh	perHour	min	-Min	perMin

A2 - (Default Analysis Set) - D1 - Existing 2012, PM 1700 - 1800

Data Errors and Warnings

No errors or warnings

Analysis Set Details

Name	Description	Include In Report	Use Specific Demand Set	Demand Set	Locked	Network Flow Scaling Factor (%)	Network Capacity Scaling Factor (%)	Reason For Scaling Factors
(Default Analysis Set)		Yes		(D1)		100.000	100.000	

Demand Set Details

Name	Scenario Name	Time Period Name	Description	Locked	Run Automatically	Use Relationship	Relationship	Start Time (HH:mm)	Finish Time (HH:mm)	Time Period Length	Time Segment Length	Traffic Profile Type
------	---------------	------------------	-------------	--------	-------------------	------------------	--------------	--------------------	---------------------	--------------------	---------------------	----------------------

Existing 2012, PM 1700 - 1800	Existing 2012	PM 1700 - 1800	Peak Hour Flows		Yes			16:45	18:15	90	15	ONE HOUR
-------------------------------	---------------	----------------	-----------------	--	-----	--	--	-------	-------	----	----	----------

Roundabout Network

Roundabout Type(s)

ID	Name	Arm Order	Roundabout Type	Grade Separated	Large Roundabout	Do Geometric Delay
1	Boxted Road/The Avenue Roundabout	1,2,3,4	Standard			

Roundabout Network Options

Driving Side	Lighting	Road Surface	In London
Left	Normal/unknown	((Mini-roundabouts only))	

Arms

Arms

ID	Name	Description
1	Boxted Road North	Single Carriageway
2	Warmark Road	Single Carriageway
3	Boxted Road South	Single Carriageway
4	The Avenue	Single Carriageway

Capacity Options

Arm	Minimum Capacity (PCU/hr)	Maximum Capacity (PCU/hr)	Assume Flat Start Profile	Initial Queue (PCU)
Boxted Road North	0.00	99999.00		0.00
Warmark Road	0.00	99999.00		0.00
Boxted Road South	0.00	99999.00		0.00
The Avenue	0.00	99999.00		0.00

Standard Geometry

Arm	V - Approach road half-width (m)	E - Entry width (m)	I' - Effective flare length (m)	R - Entry radius (m)	D - Inscribed circle diameter (m)	PHI - Conflict (entry) angle (deg)	Exit Only
Boxted Road North	3.40	5.00	6.00	10.00	24.00	31.00	
Warmark Road	2.50	3.80	3.50	13.50	24.50	27.50	
Boxted Road South	3.50	4.50	9.00	20.00	24.00	19.00	
The Avenue	3.45	5.10	12.00	29.00	24.50	17.00	

Pedestrian Crossings

Arm	Crossing Type
Boxted Road North	None
Warmark Road	None
Boxted Road South	None
The Avenue	None

Arm Slope/ Intercept and Capacity

Slope and Intercept used in model

Arm	Enter Directly	Slope	Intercept (PCU/hr)	Final Slope	Final Intercept (PCU/hr)
Boxted Road North		((calculated))	((calculated))	0.548	1224.132
Warmark Road		((calculated))	((calculated))	0.498	923.541
Boxted Road South		((calculated))	((calculated))	0.599	1333.036
The Avenue		((calculated))	((calculated))	0.635	1476.488

The slope and intercept shown above include any corrections and adjustments.

Traffic Flows

Demand Set Data Options

Default Vehicle Mix	Vehicle Mix Varies Over Time	Vehicle Mix Varies Over Turn	Vehicle Mix Varies Over Entry	Vehicle Mix Source	PCU Factor for a HV (PCU)	Default Turning Proportions	Estimate from entry/exit counts	Turning Proportions Vary Over Time	Turning Proportions Vary Over Turn	Turning Proportions Vary Over Entry
	Yes	Yes	Yes	HV Percentages	2.00				Yes	Yes

Entry Flows

General Flows Data

Arm	Profile Type	Use Turning Counts	Average Demand Flow (Veh/hr)	Flow Scaling Factor (%)	PHF
Boxted Road North	ONE HOUR	Yes	377.00	100.000	N/A
Warmark Road	ONE HOUR	Yes	8.00	100.000	N/A
Boxted Road South	ONE HOUR	Yes	491.00	100.000	N/A
The Avenue	ONE HOUR	Yes	60.00	100.000	N/A

Direct/Resultant Flows

Direct Flows Data

Time Segment	Arm	Direct Demand Entry Flow (Veh/hr)	DirectDemandEntryFlowInPCU (PCU/hr)	Direct Demand Exit Flow (Veh/hr)	Direct Demand Pedestrian Flow (Ped/hr)
16:45-17:00	Boxted Road North	283.83	286.84	N/A	N/A
16:45-17:00	Warmark Road	6.02	6.02	N/A	N/A
16:45-17:00	Boxted Road South	369.65	375.66	N/A	N/A
16:45-17:00	The Avenue	45.17	46.69	N/A	N/A
17:00-17:15	Boxted Road North	338.92	359.65	N/A	N/A
17:00-17:15	Warmark Road	7.19	8.16	N/A	N/A
17:00-17:15	Boxted Road South	441.40	512.35	N/A	N/A
17:00-17:15	The Avenue	53.94	58.73	N/A	N/A
17:15-17:30	Boxted Road North	415.08	440.48	N/A	N/A
17:15-17:30	Warmark Road	8.81	9.99	N/A	N/A
17:15-17:30	Boxted Road South	540.60	627.49	N/A	N/A
17:15-17:30	The Avenue	66.06	71.93	N/A	N/A
17:30-17:45	Boxted Road North	415.08	440.48	N/A	N/A
17:30-17:45	Warmark Road	8.81	9.99	N/A	N/A
17:30-17:45	Boxted Road South	540.60	627.49	N/A	N/A
17:30-17:45	The Avenue	66.06	71.93	N/A	N/A
17:45-18:00	Boxted Road North	338.92	357.21	N/A	N/A
17:45-18:00	Warmark Road	7.19	7.55	N/A	N/A
17:45-18:00	Boxted Road South	441.40	463.47	N/A	N/A
17:45-18:00	The Avenue	53.94	56.64	N/A	N/A
18:00-18:15	Boxted Road North	283.83	299.15	N/A	N/A
18:00-18:15	Warmark Road	6.02	6.32	N/A	N/A
18:00-18:15	Boxted Road South	369.65	388.13	N/A	N/A
18:00-18:15	The Avenue	45.17	47.43	N/A	N/A

Turning Proportions

Turning Counts or Proportions (Veh/hr) - Roundabout 1 (for whole period)

		To			
		1	2	3	4
1	0.00	3.00	357.00	17.00	

	2	2.00	0.00	6.00	0.00
From	3	358.00	3.00	0.00	130.00
	4	12.00	0.00	48.00	0.00

Turning Proportions (Veh) - Roundabout 1 (for whole period)

		To			
		1	2	3	4
From	1	0.00	0.01	0.95	0.05
	2	0.25	0.00	0.75	0.00
	3	0.73	0.01	0.00	0.26
	4	0.20	0.00	0.80	0.00

Vehicle Mix

Average PCU Per Vehicle - Roundabout 1 - (16:45-17:00)

		To			
		1	2	3	4
From	1	1.00	1.00	1.01	1.00
	2	1.00	1.00	1.00	1.00
	3	1.02	1.00	1.00	1.01
	4	1.00	1.00	1.04	1.00

Heavy Vehicle Percentages - Roundabout 1 - (16:45-17:00)

		To			
		1	2	3	4
From	1	0.00	0.00	1.12	0.00
	2	0.00	0.00	0.00	0.00
	3	1.95	0.00	0.00	0.77
	4	0.00	0.00	4.20	0.00

Average PCU Per Vehicle - Roundabout 1 - (17:00-17:15)

		To			
		1	2	3	4
From	1	1.00	1.00	1.06	1.04
	2	1.09	1.00	1.15	1.03
	3	1.15	1.00	1.00	1.19
	4	1.08	1.00	1.09	1.00

Heavy Vehicle Percentages - Roundabout 1 - (17:00-17:15)

		To			
		1	2	3	4
From	1	0.00	0.00	6.25	4.45
	2	8.85	0.00	15.00	2.50
	3	15.00	0.00	0.00	19.40
	4	7.69	0.00	9.18	0.00

Average PCU Per Vehicle - Roundabout 1 - (17:15-17:30)

		To			
		1	2	3	4
From	1	1.00	1.00	1.06	1.04
	2	1.09	1.00	1.15	1.03
	3	1.15	1.00	1.00	1.19
	4	1.08	1.00	1.09	1.00

Heavy Vehicle Percentages - Roundabout 1 - (17:15-17:30)

		To			
		1	2	3	4
	1	0.00	0.00	6.25	4.45

From	2	8.85	0.00	15.00	2.50
	3	15.00	0.00	0.00	19.40
	4	7.69	0.00	9.18	0.00

Average PCU Per Vehicle - Roundabout 1 - (17:30-17:45)

From	To				
		1	2	3	4
	1	1.00	1.00	1.06	1.04
	2	1.09	1.00	1.15	1.03
	3	1.15	1.00	1.00	1.19
4	1.08	1.00	1.09	1.00	

Heavy Vehicle Percentages - Roundabout 1 - (17:30-17:45)

From	To				
		1	2	3	4
	1	0.00	0.00	6.25	4.45
	2	8.85	0.00	15.00	2.50
	3	15.00	0.00	0.00	19.40
4	7.69	0.00	9.18	0.00	

Average PCU Per Vehicle - Roundabout 1 - (17:45-18:00)

From	To				
		1	2	3	4
	1	1.00	1.55	1.05	1.05
	2	1.05	1.00	1.05	1.05
	3	1.05	1.05	1.00	1.05
4	1.05	1.05	1.05	1.00	

Heavy Vehicle Percentages - Roundabout 1 - (17:45-18:00)

From	To				
		1	2	3	4
	1	0.00	55.00	5.00	5.00
	2	5.00	0.00	5.00	5.00
	3	5.00	5.00	0.00	5.00
4	5.00	5.00	5.00	0.00	

Average PCU Per Vehicle - Roundabout 1 - (18:00-18:15)

From	To				
		1	2	3	4
	1	1.00	1.55	1.05	1.05
	2	1.05	1.00	1.05	1.05
	3	1.05	1.05	1.00	1.05
4	1.05	1.05	1.05	1.00	

Heavy Vehicle Percentages - Roundabout 1 - (18:00-18:15)

From	To				
		1	2	3	4
	1	0.00	55.00	5.00	5.00
	2	5.00	0.00	5.00	5.00
	3	5.00	5.00	0.00	5.00
4	5.00	5.00	5.00	0.00	

Results

Results Summary

Arm	Max RFC	Max Delay (min)	Max Queue (Veh)	Max LOS	Total Demand (Veh/hr)	Total Arrivals (Veh)	Total Queueing Delay (Veh-min)	Average Queueing Delay (min)	Rate Of Queueing Delay (Veh-	Inclusive Queueing Total Delay	Inclusive Queueing Average Delay	Slope	Intercept (PCU/hr)
-----	---------	-----------------	-----------------	---------	-----------------------	----------------------	--------------------------------	------------------------------	------------------------------	--------------------------------	----------------------------------	-------	--------------------

									min/min)	(Veh-min)	(min)		
Boxted Road North	0.37	0.08	0.59	A	345.86	518.79	39.80	0.08	0.44	39.80	0.08	0.548	1224.132
Warmark Road	0.01	0.10	0.02	A	7.32	10.99	1.02	0.09	0.01	1.02	0.09	0.498	923.541
Boxted Road South	0.48	0.10	0.94	A	449.15	673.73	56.46	0.08	0.63	56.46	0.08	0.599	1333.036
The Avenue	0.06	0.06	0.07	A	55.03	82.55	4.50	0.05	0.05	4.50	0.05	0.635	1476.488

Main Results

Main results: (16:45-17:00)

Arm	Demand (Veh/hr)	Arrivals (Veh)	Entry Flow (Veh/hr)	Exit Flow (Veh/hr)	Circulating Flow (Veh/hr)	Pedestrian Demand (Ped/hr)	Capacity (Veh/hr)	Saturation Capacity (Veh/hr)	RFC	Start Queue (Veh)	End Queue (Veh)
Boxted Road North	283.82	70.96	282.58	278.87	38.27	0.00	1189.71	836.12	0.239	0.00	0.31
Warmark Road	6.02	1.51	5.99	4.50	316.35	0.00	763.86	165.94	0.008	0.00	0.01
Boxted Road South	369.65	92.41	368.08	308.10	14.24	0.00	1303.32	1265.05	0.284	0.00	0.39
The Avenue	45.17	11.29	45.02	110.20	272.12	0.00	1258.09	820.52	0.036	0.00	0.04

Main results: (17:00-17:15)

Arm	Demand (Veh/hr)	Arrivals (Veh)	Entry Flow (Veh/hr)	Exit Flow (Veh/hr)	Circulating Flow (Veh/hr)	Pedestrian Demand (Ped/hr)	Capacity (Veh/hr)	Saturation Capacity (Veh/hr)	RFC	Start Queue (Veh)	End Queue (Veh)
Boxted Road North	338.97	84.74	338.45	333.71	45.80	0.00	1128.04	795.20	0.301	0.30	0.43
Warmark Road	7.20	1.80	7.18	5.38	378.87	0.00	637.28	145.30	0.011	0.01	0.01
Boxted Road South	441.57	110.39	440.44	368.99	17.06	0.00	1139.66	1109.17	0.387	0.34	0.63
The Avenue	53.95	13.49	53.89	131.87	325.62	0.00	1138.17	786.95	0.047	0.04	0.05

Main results: (17:15-17:30)

Arm	Demand (Veh/hr)	Arrivals (Veh)	Entry Flow (Veh/hr)	Exit Flow (Veh/hr)	Circulating Flow (Veh/hr)	Pedestrian Demand (Ped/hr)	Capacity (Veh/hr)	Saturation Capacity (Veh/hr)	RFC	Start Queue (Veh)	End Queue (Veh)
Boxted Road North	415.09	103.77	414.46	408.78	56.10	0.00	1122.07	795.07	0.370	0.43	0.58
Warmark Road	8.81	2.20	8.79	6.59	463.97	0.00	597.21	145.23	0.015	0.01	0.01
Boxted Road South	540.60	135.15	539.53	451.87	20.89	0.00	1137.14	1108.74	0.475	0.63	0.90
The Avenue	66.06	16.52	66.00	161.54	398.88	0.00	1088.88	786.85	0.061	0.05	0.06

Main results: (17:30-17:45)

Arm	Demand (Veh/hr)	Arrivals (Veh)	Entry Flow (Veh/hr)	Exit Flow (Veh/hr)	Circulating Flow (Veh/hr)	Pedestrian Demand (Ped/hr)	Capacity (Veh/hr)	Saturation Capacity (Veh/hr)	RFC	Start Queue (Veh)	End Queue (Veh)
Boxted Road North	415.09	103.77	415.08	409.56	56.15	0.00	1122.04	795.07	0.370	0.58	0.58
Warmark Road	8.81	2.20	8.81	6.61	464.62	0.00	596.90	145.23	0.015	0.01	0.01
Boxted Road South	540.60	135.15	540.58	452.51	20.92	0.00	1137.12	1108.74	0.475	0.90	0.90
The Avenue	66.06	16.52	66.06	161.84	399.65	0.00	1088.36	786.85	0.061	0.06	0.06

Main results: (17:45-18:00)

Arm	Demand (Veh/hr)	Arrivals (Veh)	Entry Flow (Veh/hr)	Exit Flow (Veh/hr)	Circulating Flow (Veh/hr)	Pedestrian Demand (Ped/hr)	Capacity (Veh/hr)	Saturation Capacity (Veh/hr)	RFC	Start Queue (Veh)	End Queue (Veh)
Boxted Road North	338.90	84.72	339.54	335.45	45.91	0.00	1136.31	803.78	0.298	0.59	0.43
Warmark Road	7.19	1.80	7.21	5.41	380.05	0.00	689.92	160.40	0.010	0.02	0.01
Boxted Road South	440.98	110.25	442.79	370.14	17.11	0.00	1258.12	1222.67	0.351	0.99	0.54
The Avenue	53.93	13.48	54.01	132.54	327.36	0.00	1197.91	809.16	0.045	0.07	0.05

Main results: (18:00-18:15)

Arm	Demand (Veh/hr)	Arrivals (Veh)	Entry Flow (Veh/hr)	Exit Flow (Veh/hr)	Circulating Flow (Veh/hr)	Pedestrian Demand (Ped/hr)	Capacity (Veh/hr)	Saturation Capacity (Veh/hr)	RFC	Start Queue (Veh)	End Queue (Veh)
Boxted Road North	283.83	70.96	284.20	280.44	38.43	0.00	1140.45	803.82	0.249	0.43	0.33
Warmark Road	6.02	1.51	6.03	4.52	318.11	0.00	721.25	160.51	0.008	0.01	0.01
Boxted Road South	369.65	92.41	370.16	309.82	14.32	0.00	1260.98	1223.82	0.293	0.54	0.42
The Avenue	45.17	11.29	45.21	110.82	273.66	0.00	1232.40	809.31	0.037	0.05	0.04

Queueing Delay Results

Queueing Delay results: (16:45-17:00)

Arm	Queueing Total Delay (Veh-min)	Queueing Rate Of Delay (Veh-min/min)	Average Delay Per Arriving Vehicle (min)	Unsignalised Level Of Service	Signalised Level Of Service
Boxted Road North	4.56	0.30	0.066	A	A
Warmark Road	0.12	0.01	0.079	A	A
Boxted Road South	5.76	0.38	0.064	A	A
The Avenue	0.55	0.04	0.049	A	A

Queueing Delay results: (17:00-17:15)

Arm	Queueing Total Delay (Veh-min)	Queueing Rate Of Delay (Veh-min/min)	Average Delay Per Arriving Vehicle (min)	Unsignalised Level Of Service	Signalised Level Of Service
Boxted Road North	6.27	0.42	0.076	A	A
Warmark Road	0.17	0.01	0.095	A	A
Boxted Road South	9.15	0.61	0.086	A	A
The Avenue	0.73	0.05	0.055	A	A

Queueing Delay results: (17:15-17:30)

Arm	Queueing Total Delay (Veh-min)	Queueing Rate Of Delay (Veh-min/min)	Average Delay Per Arriving Vehicle (min)	Unsignalised Level Of Service	Signalised Level Of Service
Boxted Road North	8.54	0.57	0.085	A	A
Warmark Road	0.22	0.01	0.102	A	A
Boxted Road South	13.04	0.87	0.100	A	A
The Avenue	0.95	0.06	0.059	A	A

Queueing Delay results: (17:30-17:45)

Arm	Queueing Total Delay (Veh-min)	Queueing Rate Of Delay (Veh-min/min)	Average Delay Per Arriving Vehicle (min)	Unsignalised Level Of Service	Signalised Level Of Service
Boxted Road North	8.75	0.58	0.085	A	A
Warmark Road	0.22	0.01	0.102	A	A
Boxted Road South	13.48	0.90	0.101	A	A
The Avenue	0.97	0.06	0.059	A	A

Queueing Delay results: (17:45-18:00)

Arm	Queueing Total Delay (Veh-min)	Queueing Rate Of Delay (Veh-min/min)	Average Delay Per Arriving Vehicle (min)	Unsignalised Level Of Service	Signalised Level Of Service
Boxted Road North	6.56	0.44	0.075	A	A
Warmark Road	0.16	0.01	0.088	A	A
Boxted Road South	8.38	0.56	0.074	A	A
The Avenue	0.72	0.05	0.052	A	A

Queueing Delay results: (18:00-18:15)

Arm	Queueing Total Delay (Veh-min)	Queueing Rate Of Delay (Veh-min/min)	Average Delay Per Arriving Vehicle (min)	Unsignalised Level Of Service	Signalised Level Of Service
Boxted Road North	5.09	0.34	0.070	A	A
Warmark Road	0.13	0.01	0.084	A	A
Boxted Road South	6.37	0.42	0.067	A	A
The Avenue	0.58	0.04	0.051	A	A

Overview: Standard Roundabout Geometry

Standard Geometry

Arm	V - Approach road half-width (m)	E - Entry width (m)	I' - Effective flare length (m)	R - Entry radius (m)	D - Inscribed circle diameter (m)	PHI - Conflict (entry) angle (deg)	Exit Only	Final Slope	Final Intercept (PCU/hr)
Boxted Road North	3.40	5.00	6.00	10.00	24.00	31.00		0.548	1224.132
Warmark Road	2.50	3.80	3.50	13.50	24.50	27.50		0.498	923.541
Boxted Road South	3.50	4.50	9.00	20.00	24.00	19.00		0.599	1333.036
The Avenue	3.45	5.10	12.00	29.00	24.50	17.00		0.635	1476.488

Overview: Time Segment Results

Time Segment Results

Time Segment	Arm	Demand (Veh/hr)	Capacity (Veh/hr)	RFC	Pedestrian Demand (Ped/hr)	Start Queue (Veh)	End Queue (Veh)	Queueing Total Delay (Veh-min)	Geometric Total Delay (Veh-min)	Average Delay Per Arriving Vehicle (min)
16:45-17:00	Boxted Road North	283.82	1189.71	0.239	0.00	0.00	0.31	4.56	(16.29)	0.066
16:45-17:00	Warmark Road	6.02	763.86	0.008	0.00	0.00	0.01	0.12	(22.65)	0.079
16:45-17:00	Boxted Road South	369.65	1303.32	0.284	0.00	0.00	0.39	5.76	(18.54)	0.064
16:45-17:00	The Avenue	45.17	1258.09	0.036	0.00	0.00	0.04	0.55	(16.06)	0.049
17:00-17:15	Boxted Road North	338.97	1128.04	0.301	0.00	0.30	0.43	6.27	(15.51)	0.076
17:00-17:15	Warmark Road	7.20	637.28	0.011	0.00	0.01	0.01	0.17	(19.98)	0.095
17:00-17:15	Boxted Road South	441.57	1139.66	0.387	0.00	0.34	0.63	9.15	(16.24)	0.086
17:00-17:15	The Avenue	53.95	1138.17	0.047	0.00	0.04	0.05	0.73	(15.25)	0.055
17:15-17:30	Boxted Road North	415.09	1122.07	0.370	0.00	0.43	0.58	8.54	(15.51)	0.085
17:15-17:30	Warmark Road	8.81	597.21	0.015	0.00	0.01	0.01	0.22	(19.97)	0.102
17:15-17:30	Boxted Road South	540.60	1137.14	0.475	0.00	0.63	0.90	13.04	(16.23)	0.100
17:15-17:30	The Avenue	66.06	1088.88	0.061	0.00	0.05	0.06	0.95	(15.24)	0.059
17:30-17:45	Boxted Road North	415.09	1122.04	0.370	0.00	0.58	0.58	8.75	(15.51)	0.085
17:30-17:45	Warmark Road	8.81	596.90	0.015	0.00	0.01	0.01	0.22	(19.97)	0.102
17:30-17:45	Boxted Road South	540.60	1137.12	0.475	0.00	0.90	0.90	13.48	(16.23)	0.101
17:30-17:45	The Avenue	66.06	1088.36	0.061	0.00	0.06	0.06	0.97	(15.24)	0.059
17:45-18:00	Boxted Road North	338.90	1136.31	0.298	0.00	0.59	0.43	6.56	(15.62)	0.075
17:45-18:00	Warmark Road	7.19	689.92	0.010	0.00	0.02	0.01	0.16	(21.56)	0.088
17:45-18:00	Boxted Road South	440.98	1258.12	0.351	0.00	0.99	0.54	8.38	(17.93)	0.074
17:45-18:00	The Avenue	53.93	1197.91	0.045	0.00	0.07	0.05	0.72	(15.80)	0.052
18:00-18:15	Boxted Road North	283.83	1140.45	0.249	0.00	0.43	0.33	5.09	(15.62)	0.070
18:00-18:15	Warmark Road	6.02	721.25	0.008	0.00	0.01	0.01	0.13	(21.58)	0.084
18:00-18:15	Boxted Road South	369.65	1260.98	0.293	0.00	0.54	0.42	6.37	(17.95)	0.067
18:00-18:15	The Avenue	45.17	1232.40	0.037	0.00	0.05	0.04	0.58	(15.81)	0.051



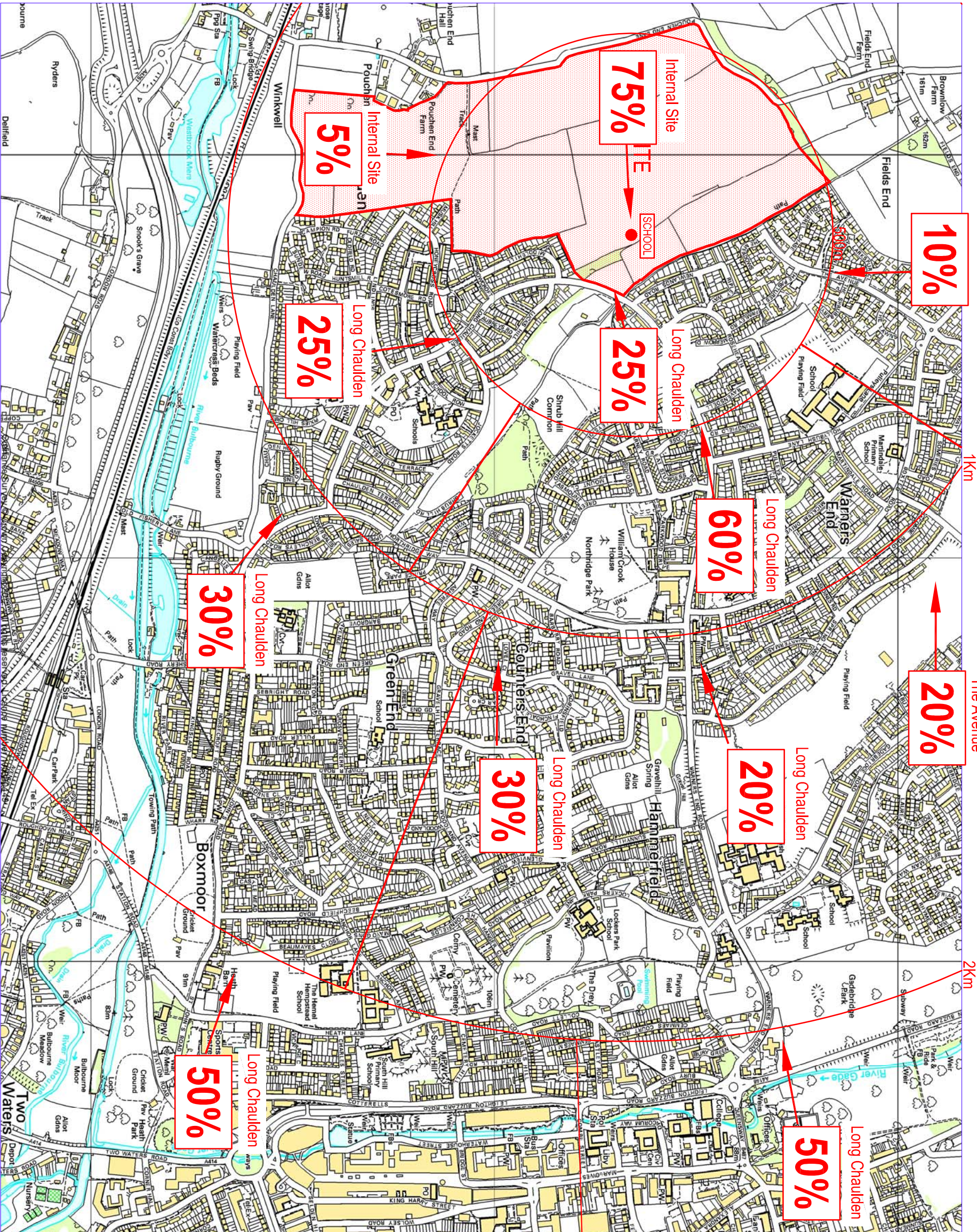

KEY	
Site	
Site Boundary	

Rev	Description	Revisions	Date	Drawn	Checked
A	Minor identification amendments		20.7.12	DGS	NLM

CIVIL ENGINEERING CONSULTANTS

 Registered Office:

 32 Barkhale Lane, Woking, Surrey, GU24 0NF

 Design Office:

 19 Midhurst Road, Woking, Surrey, GU24 0SP

 Tel: 01428 815483 Fax: 01428 616426

 Email: info@stomor.com www.stomor.com

Project: Land at Fields End, Hemel Hempstead

 Drawing Description: Percentage Assignment of Cars to the School in the AM Peak Period

Scale	Date	Drawn By	Checked By
1:10,000 @ A3	11/04/12	LAF	DGS

Notes	Drawing Number
Do not scale off the drawing. Only written dimensions should be taken. Any dimensions of fit shown should be thought of as minimum.	ST-2189-11-A

EXISTING AVI

Key		
Housing 0-2Km Flows	- 59 Out, 23 In	10
Housing 2-5Km Flows	- 162 Out, 65 In	15
Housing 5km + Flows	- 229 Out, 92 In	20
Total	- 450 Out, 180 In	25

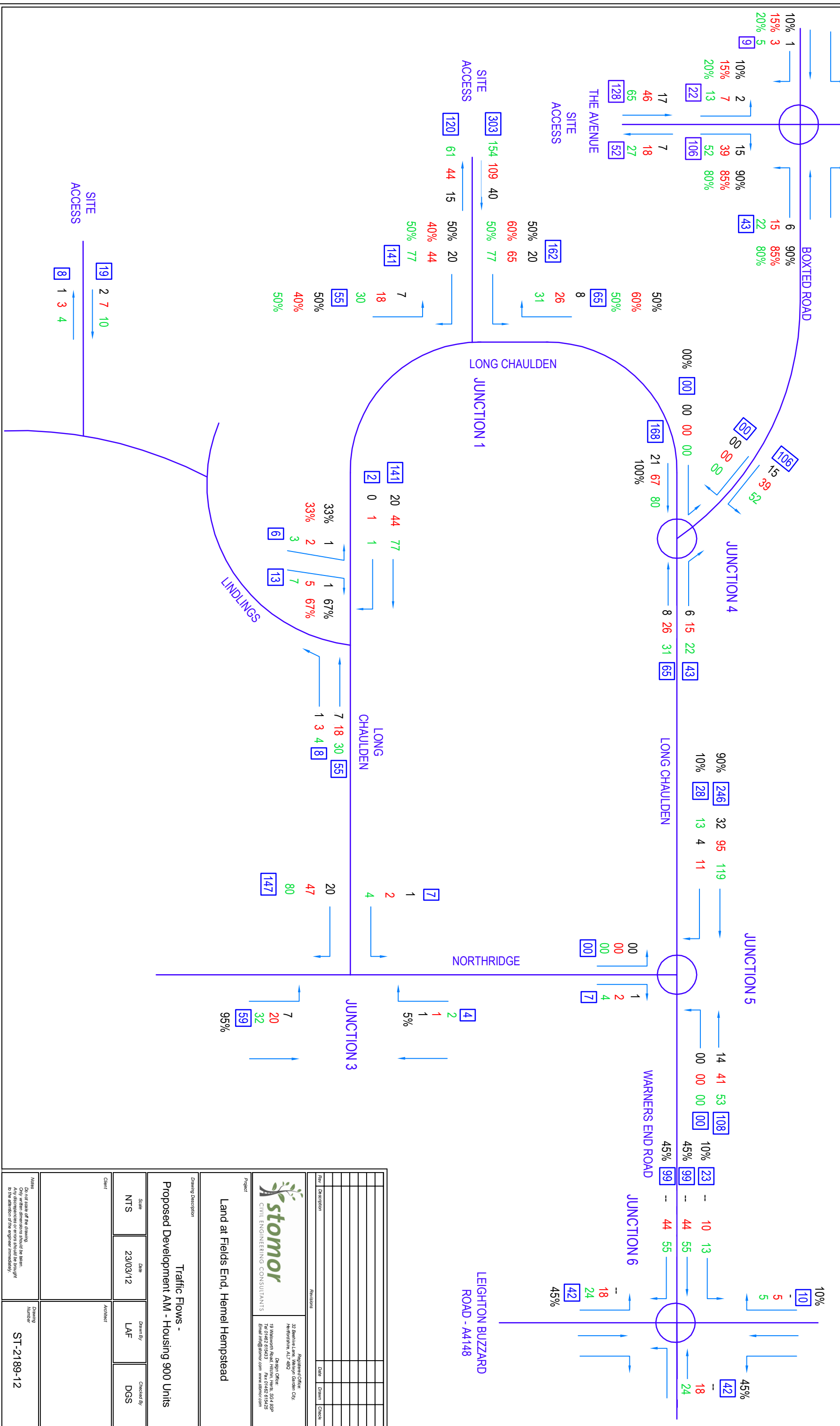

<p>33 Bushfield Road, Hemel Hempstead, AL1 4EP 19 Watlington Road, Hemel Hempstead, AL1 4SP Email: info@stomor.com www.stomor.com</p>		<p>Registered Office: 33 Bushfield Road, Hemel Hempstead, AL1 4EP Dialling Office: 19 Watlington Road, Hemel Hempstead, AL1 4SP Tel: 01462 619433 Fax: 01462 619435 Email: info@stomor.com www.stomor.com</p>	
<p>Project Land at Fields End, Hemel Hempstead</p>			
<p>Drawing Description Traffic Flows - Proposed Development AM - Housing 900 Units</p>			
Scale	Date	Drawn By	Checked By
NTS	23/03/12	LAF	DGS
Client		Architect	
<p>Notes Do not scale off the drawing. Only measurements should be taken from the drawing. By the attention of the engineer immediately.</p>		<p>Drawing Number ST-2189-12</p>	

Key

Pupil Vehicles	10
Staff vehicles (AM only)	15
Community	20
Totals	3 14 22

Notes

2 FE Primary School
 Long Chaulden 90% / 10% The Avenue
 Later Analysis: 450 pupils x 20% by car, car share rate 1.4
 = 64 Vehicles (128 2-way pupil related)
 Staff
 Typical 42 in AM period
 Pupils and Staff
 Total: 106 in and 64 out - AM

Community
 All from Long Chaulden
 10% of units at 20% by car
 18 in and 10 out - nominal
 50% from within development
 50% from east
 Total: 9 in and 5 out

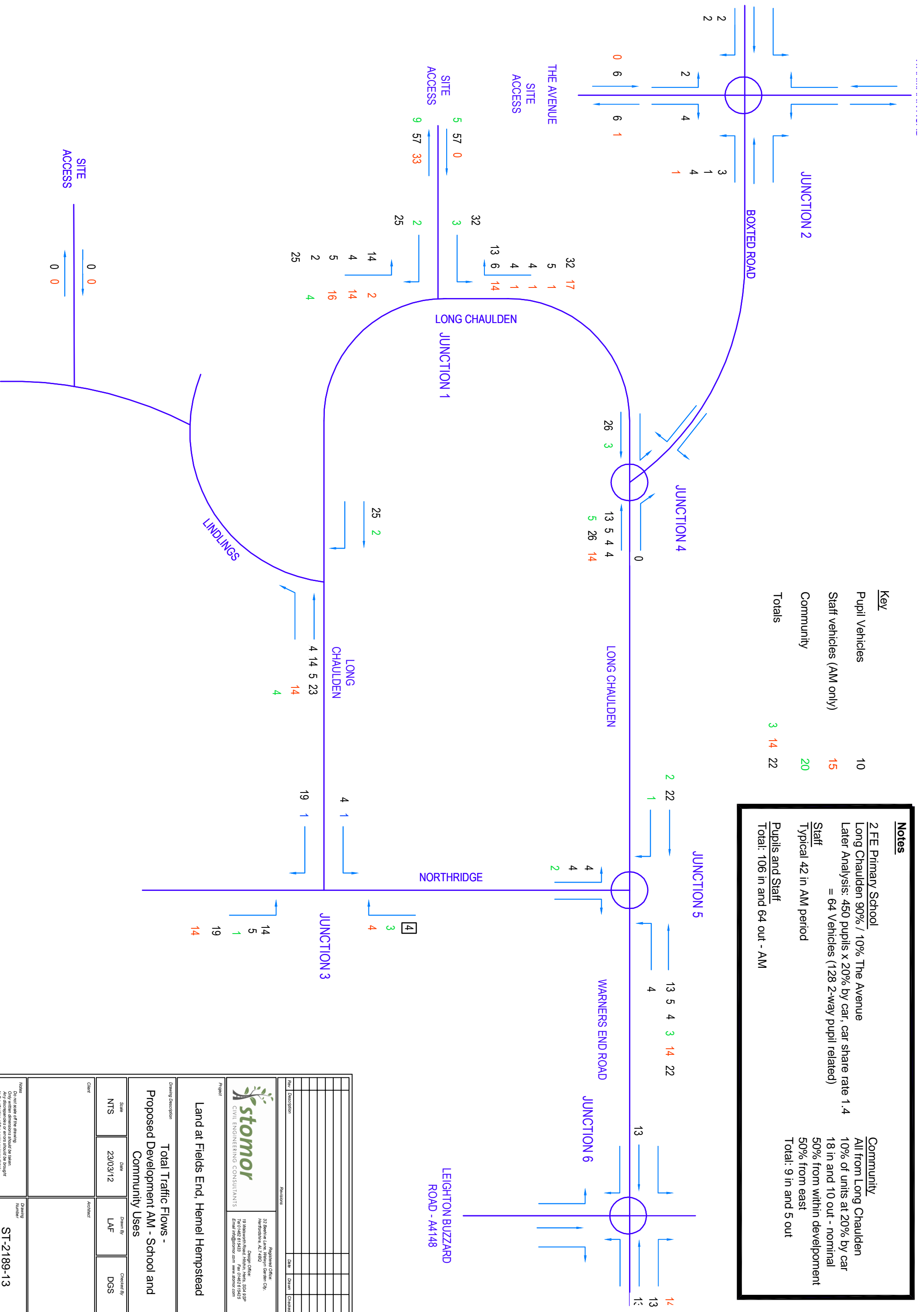

stomor
 CIVIL ENGINEERING CONSULTANTS

Registered Office:
 32 Bevine Lane, Watlyn Garden City,
 Harrogate, A1 7 4BP

Design Office:
 19 Melbourn Road, Peterborough, PE3 6JG
 Tel: 01832 614520
 Email: info@stomor.com www.stomor.com

Project: Land at Fields End, Hemel Hempstead

Drawing Description: Total Traffic Flows - Proposed Development AM - School and Community Uses

Scale: NTS	Date: 23/03/12	Drawn By: LAF	Checked By: DGS
Client:		Architect:	
Notes:	Do not scale off the drawing. Only written dimensions should be taken. Any discrepancies or errors should be brought to the attention of the engineer immediately.		
Drawing Number: ST-2189-13			

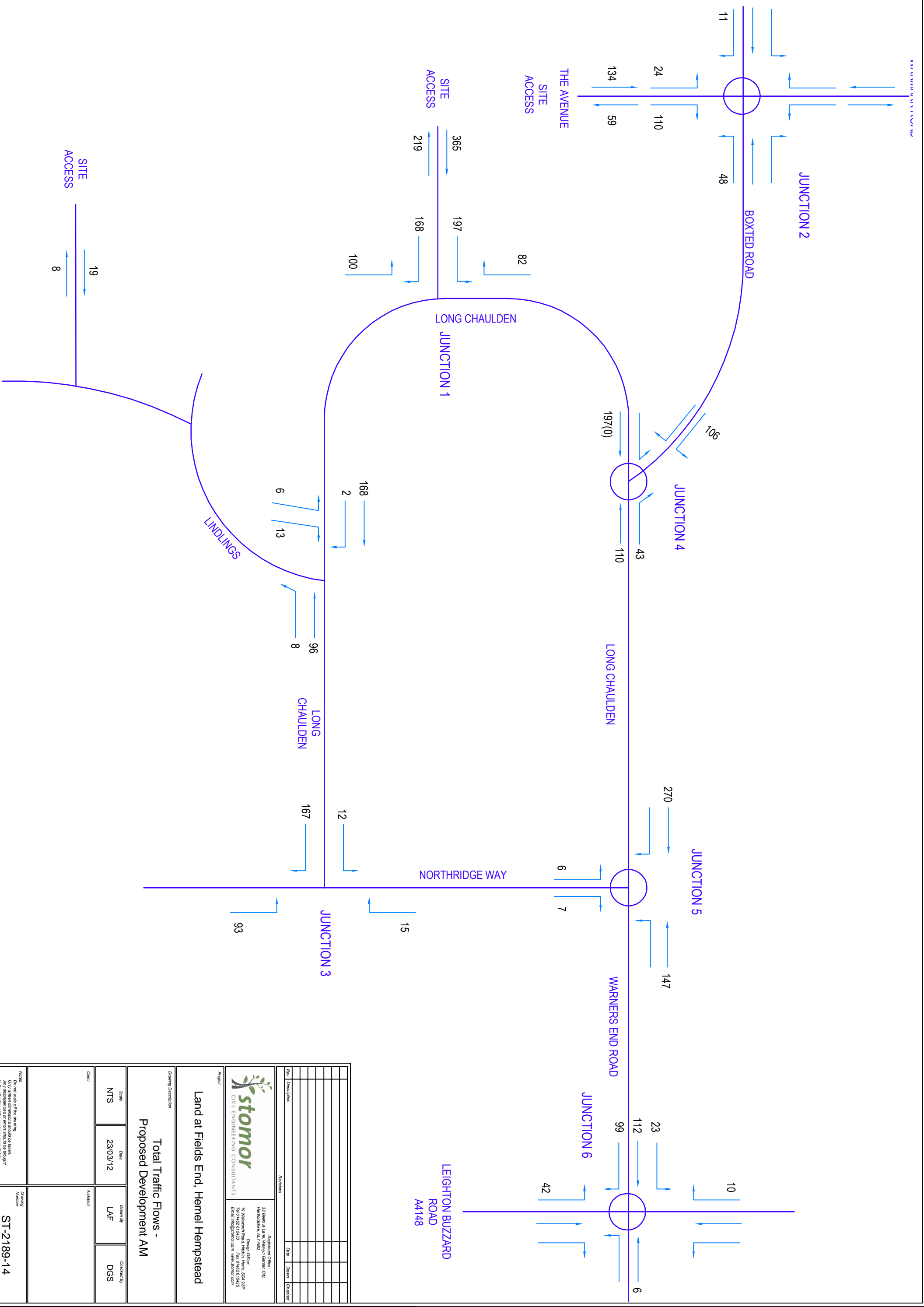

Rev	Description	Date	Drawn	Checked

Project: Land at Fields End, Hemel Hempstead

Drawing Description: Total Traffic Flows - Proposed Development AM

Scale	Date	Drawn By	Checked By
NTS	23/03/12	LAF	DGS
Client		Architect	

Revision:

Notes: Do not scale off the drawing. Only written dimensions should be taken. Any discrepancy or errors should be brought to the attention of the Engineer immediately.

Drawing Number: ST-2189-14

stomor
CIVIL ENGINEERING CONSULTANTS

Registered Office:
32 Bevine Lane, Watlyn Garden City,
Hemel Hempstead, AL2 7AP

Design Office:
19 Millbrook Road, Hemel Hempstead, SG14 6SP
Tel: 0462 614543
Fax: 0462 614542
Email: info@stomor.com www.stomor.com



Key

Housing Traffic	216
Community use Traffic	3
Total	219

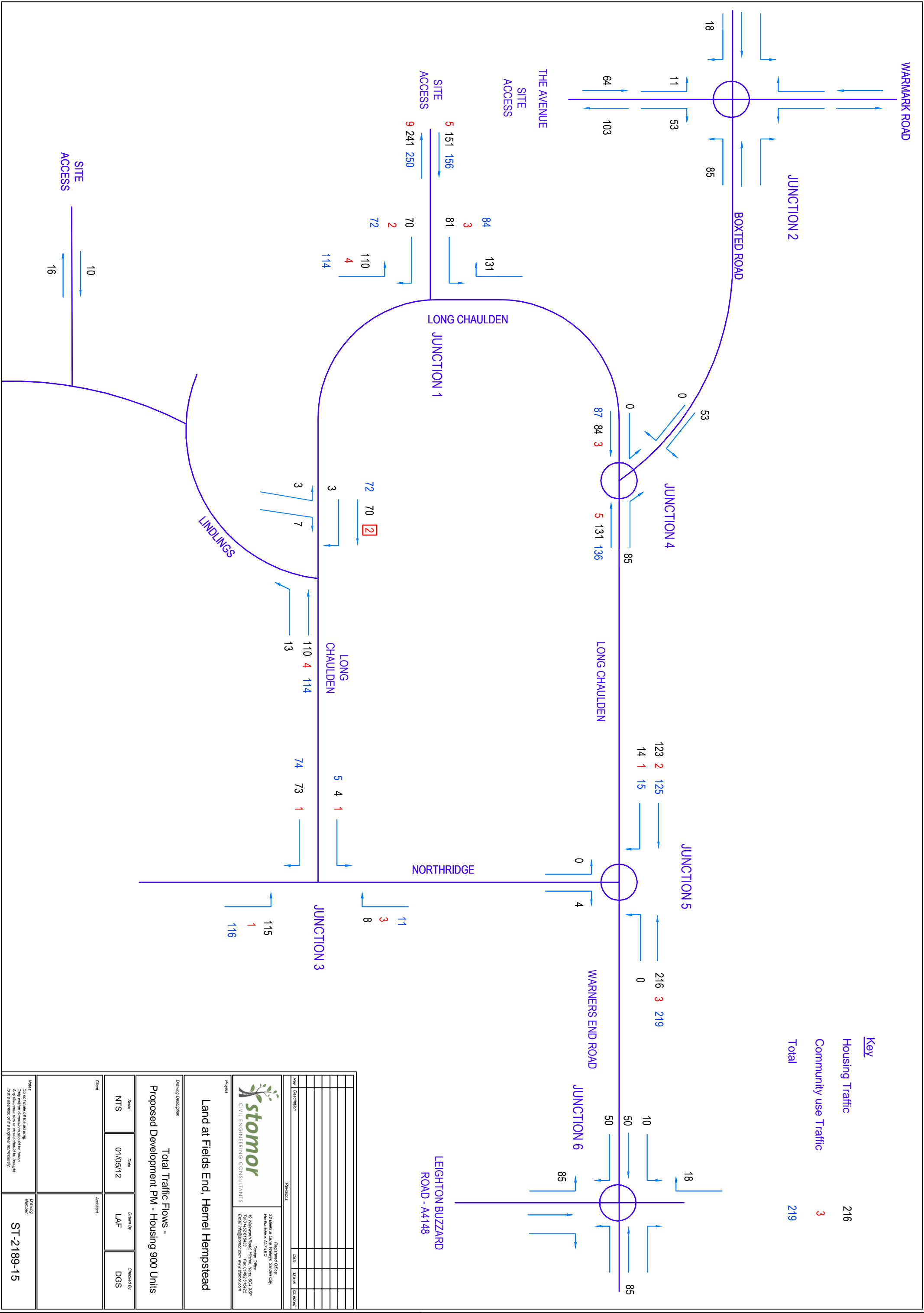

<p>Registered Office: 32 Bevine Lane, Warnemere, Great Yarmouth, Norfolk, UK, NR11 1BB</p> <p>Design Office: 19 Midhurst Road, Fordingham, Norfolk, UK, NR11 4JG Tel: 01693 614523 Email: info@stomor.com www.stomor.com</p>			
<p>Project Land at Fields End, Hemel Hempstead</p>			
<p>Drawing Description Total Traffic Flows - Proposed Development PM - Housing 900 Units</p>			
Scale	Date	Drawn By	Checked By
NTS	01/05/12	LAF	DGS
Client	Architect		
<p>Notes: Do not scale off the drawing. Only written dimensions should be taken. Any discrepancies or errors should be brought to the attention of the signifier immediately.</p>		Drawing Number	
		ST-2189-15	

17:00 - 18:00
Year 2031 Growth - 1.164%

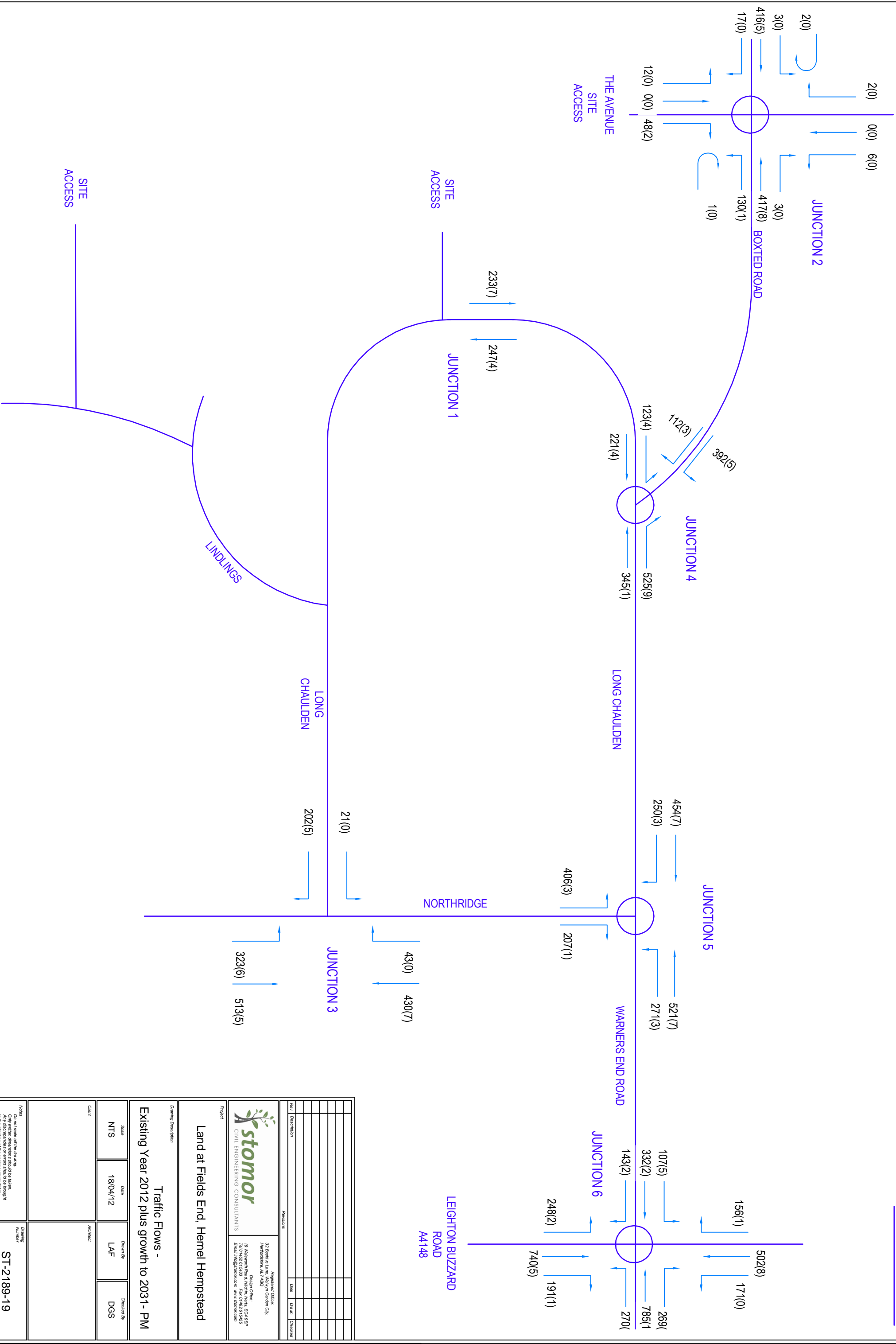

stomor
CIVIL ENGINEERING CONSULTANTS

Registered Office:
32 Bevine Lane, Watlyn Garden, City,
Northampton, Nt, NN2 7AB

Design Office:
19 Millbrook Road, Henson, Oundle, NN2 5LQ
Tel: 01832 614543
Fax: 01832 614542
Email: info@stomor.com www.stomor.com

Project:
Land at Fields End, Hemel Hempstead

Drawing Description:
**Traffic Flows -
Existing Year 2012 plus growth to 2031 - PM**

Scale	Date	Drawn By	Checked By
NTS	18/04/12	LAF	DGS
Client		Architect	

Notes	Drawing Number
Do not scale of this drawing. Only written dimensions should be taken. Any discrepancies or errors should be brought to the attention of the engineer immediately.	ST-2189-19

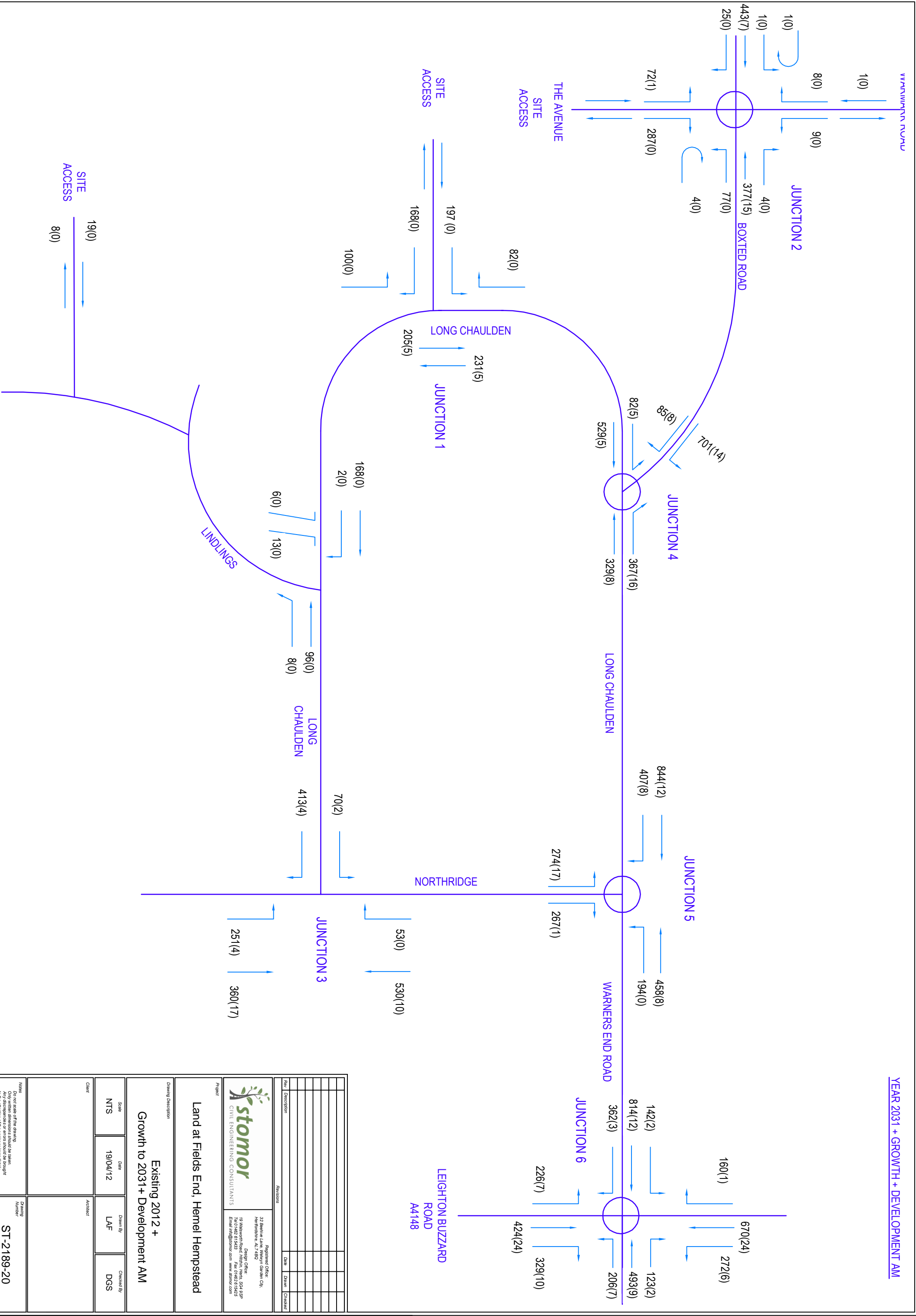

Rev	Description	Revised	Date	Drawn	Checked

stomor
CIVIL ENGINEERING CONSULTANTS

Registered Office:
32 Bevinge Lane, Warners Garden, City,
Northridge, A4 7AB

Design Office:
19 Millbrook Road, Hemel Hempstead, SG14 4BP
Tel: 0462 614543
Fax: 0462 614542
Email: info@stomor.com www.stomor.com

Project:
Land at Fields End, Hemel Hempstead

Drawing Description:
Existing 2012 +
Growth to 2031 + Development AM

Scale	Date	Drawn By	Checked By
NTS	19/04/12	LAF	DGS
Client		Architect	

Notes	Drawing Number
Do not scale of the drawing. Only written dimensions should be taken. Any discrepancies or errors should be brought to the attention of the engineer immediately.	ST-2189-20



TRL LIMITED

(C) COPYRIGHT 2006

CAPACITIES, QUEUES, AND DELAYS AT 3 OR 4-ARM MAJOR/MINOR PRIORITY JUNCTIONS

PICADY 5.1 ANALYSIS PROGRAM
RELEASE 4.0 (SEPT 2008)

ADAPTED FROM PICADY/3 WHICH IS CROWN COPYRIGHT
BY PERMISSION OF THE CONTROLLER OF HMSO

FOR SALES AND DISTRIBUTION INFORMATION,
PROGRAM ADVICE AND MAINTENANCE CONTACT:
TRL SOFTWARE BUREAU
TEL: CROWTHORNE (01344) 770758, FAX: 770356
EMAIL: Software@trl.co.uk

THE USER OF THIS COMPUTER PROGRAM FOR THE SOLUTION OF AN ENGINEERING PROBLEM IS
IN NO WAY RELIEVED OF HIS/HER RESPONSIBILITY FOR THE CORRECTNESS OF THE SOLUTION

Run with file:-
"Z:\Stomor Ltd\2100 Projects\2189-Hemel Hempstead- Land at Fields End\PICADY\Junction 1\AM-Peak-2031.vpi"
(drive-on-the-left) at 09:29:03 on Wednesday, 23 May 2012

RUN INFORMATION

RUN TITLE : AM Peak 0800-0900 - 2012- Existing plus 900 house development plus school
LOCATION : Junction of Long Chaulden with Site Access
DATE : 17/05/12
CLIENT : Taylor Wimpey
ENUMERATOR : duncan [DUNCAN]
JOB NUMBER : ST-2189
STATUS : TIA
DESCRIPTION : Year 2012 - Junction of Long Chaulden with Site Access AM 0800-0900
- Existing traffic flows plus 900 house development plus school,
with ODTAB table.

MAJOR/MINOR JUNCTION CAPACITY AND DELAY

INPUT DATA

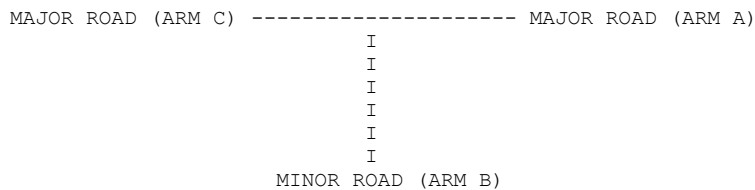

ARM A IS Long Chaulden South
ARM B IS Site Access
ARM C IS Long Chaulden North

STREAM LABELLING CONVENTION

STREAM A-B CONTAINS TRAFFIC GOING FROM ARM A TO ARM B
STREAM B-AC CONTAINS TRAFFIC GOING FROM ARM B TO ARM A AND TO ARM C
ETC.

 GEOMETRIC DATA

I	DATA ITEM	I	MINOR ROAD B	I
I	TOTAL MAJOR ROAD CARRIAGEWAY WIDTH	I	(W) 7.00 M.	I
I	CENTRAL RESERVE WIDTH	I	(WCR) 0.00 M.	I
I	MAJOR ROAD RIGHT TURN - WIDTH	I	(WC-B) 3.00 M.	I
I	- VISIBILITY	I	(VC-B) 120.00 M.	I
I	- BLOCKS TRAFFIC	I	NO	I
I	MINOR ROAD - VISIBILITY TO LEFT	I	(VB-C) 90.0 M.	I
I	- VISIBILITY TO RIGHT	I	(VB-A) 45.0 M.	I
I	- LANE 1 WIDTH	I	(WB-C) -	I
I	- LANE 2 WIDTH	I	(WB-A) -	I
I	WIDTH AT 0 M FROM JUNCTION	I	10.00 M.	I
I	WIDTH AT 5 M FROM JUNCTION	I	4.00 M.	I
I	WIDTH AT 10 M FROM JUNCTION	I	3.34 M.	I
I	WIDTH AT 15 M FROM JUNCTION	I	3.34 M.	I
I	WIDTH AT 20 M FROM JUNCTION	I	3.34 M.	I
I	- LENGTH OF FLARED SECTION	I	1 VEHS	I

 .SLOPES AND INTERCEPT

(NB:Streams may be combined, in which case capacity will be adjusted)

I	Intercept For	Slope For	Opposing	Slope For	Opposing	I
I	STREAM B-C	STREAM	A-C	STREAM	A-B	I
I	0.00	0.00	0.00	0.00	0.00	I

* Due to the presence of a flare, data is not available

I	Intercept For	Slope For	Opposing	Slope For	Opposing	Slope For	Opposing	Slope For	Opposing	I
I	STREAM B-A	STREAM	A-C	STREAM	A-B	STREAM	C-A	STREAM	C-B	I
I	0.00	0.00	0.00	0.00	0.00	0.00	0.00	0.00	0.00	I

* Due to the presence of a flare, data is not available

I	Intercept For	Slope For	Opposing	Slope For	Opposing	I
I	STREAM C-B	STREAM	A-C	STREAM	A-B	I
I	699.48	0.26	0.26	0.26	0.26	I

(NB These values do not allow for any site specific corrections)

 TRAFFIC DEMAND DATA

I	ARM	I	FLOW SCALE (%)	I
I	A	I	100	I
I	B	I	100	I
I	C	I	100	I

Demand set: AM Flows0800 -0900

TIME PERIOD BEGINS 07.45 AND ENDS 09.15

LENGTH OF TIME PERIOD - 90 MIN.
 LENGTH OF TIME SEGMENT - 15 MIN.

DEMAND FLOW PROFILES ARE SYNTHESISED FROM TURNING COUNT DATA

I	I	NUMBER OF MINUTES FROM START WHEN			RATE OF FLOW (VEH/MIN)			I							
		I	I	I	I	I	I								
I	ARM	I	I	I	I	I	I	I							
I		TO RISE	IS REACHED	FALLING	BEFORE	AT TOP	AFTER								
I	I	I	I	I	PEAK	OF PEAK	PEAK	I							
I	ARM	A	I	15.00	I	45.00	I	75.00	I	3.81	I	5.72	I	3.81	I
I	ARM	B	I	15.00	I	45.00	I	75.00	I	4.56	I	6.84	I	4.56	I
I	ARM	C	I	15.00	I	45.00	I	75.00	I	3.91	I	5.87	I	3.91	I

Demand set: AM Flows0800 -0900

	TURNING PROPORTIONS
	TURNING COUNTS
	(PERCENTAGE OF H.V.S)

TIME	FROM/TO	ARM	A	ARM	B	ARM	C
07.45 - 08.00	ARM A		0.000	0.328	0.672		
			0.0	100.0	205.0		
			(0.0)	(0.0)	(2.4)		
	ARM B		0.460	0.000	0.540		
			168.0	0.0	197.0		
			(0.0)	(0.0)	(0.0)		
	ARM C		0.738	0.262	0.000		
			231.0	82.0	0.0		
			(2.2)	(0.0)	(0.0)		

08.00 - 08.15	ARM A		0.000	0.328	0.672		
			0.0	0.0	0.0		
			(0.0)	(0.0)	(0.0)		
	ARM B		0.460	0.000	0.540		
			0.0	0.0	0.0		
			(0.0)	(0.0)	(0.0)		
	ARM C		0.738	0.262	0.000		
			0.0	0.0	0.0		
			(0.0)	(0.0)	(0.0)		

08.15 - 08.30	ARM A		0.000	0.328	0.672		
			0.0	0.0	0.0		
			(0.0)	(0.0)	(0.0)		
	ARM B		0.460	0.000	0.540		
			0.0	0.0	0.0		
			(0.0)	(0.0)	(0.0)		
	ARM C		0.738	0.262	0.000		
			0.0	0.0	0.0		
			(0.0)	(0.0)	(0.0)		

08.30 - 08.45	ARM A		0.000	0.328	0.672		
			0.0	0.0	0.0		
			(0.0)	(0.0)	(0.0)		
	ARM B		0.460	0.000	0.540		
			0.0	0.0	0.0		
			(0.0)	(0.0)	(0.0)		
	ARM C		0.738	0.262	0.000		
			0.0	0.0	0.0		
			(0.0)	(0.0)	(0.0)		

08.45 - 09.00	ARM A		0.000	0.328	0.672		
			0.0	0.0	0.0		
			(0.0)	(0.0)	(0.0)		
	ARM B		0.460	0.000	0.540		
			0.0	0.0	0.0		
			(0.0)	(0.0)	(0.0)		
	ARM C		0.738	0.262	0.000		
			0.0	0.0	0.0		
			(0.0)	(0.0)	(0.0)		

09.00 - 09.15	ARM A		0.000	0.328	0.672		
			0.0	0.0	0.0		
			(0.0)	(0.0)	(0.0)		
	ARM B		0.460	0.000	0.540		
			0.0	0.0	0.0		
			(0.0)	(0.0)	(0.0)		
	ARM C		0.738	0.262	0.000		
			0.0	0.0	0.0		
			(0.0)	(0.0)	(0.0)		

TIME	DEMAND (VEH/MIN)	CAPACITY (VEH/MIN)	DEMAND/ CAPACITY (RFC)	PEDESTRIAN FLOW (PEDS/MIN)	START QUEUE (VEHS)	END QUEUE (VEHS)	DELAY (VEH.MIN/ TIME SEGMENT)	GEOMETRIC DELAY (VEH.MIN/ TIME SEGMENT)	AVERAGE DELAY PER ARRIVING VEHICLE (MIN)
09.00-09.15									
B-C	2.47	10.11	0.244		0.43	0.33	5.0		0.13
B-A	2.11	8.80	0.240		0.45	0.32	4.9		0.15
C-A	2.90								
C-B	1.03	10.67	0.096		0.13	0.11	1.6		0.10
A-B	1.25								
A-C	2.57								

QUEUE FOR STREAM B-C

TIME SEGMENT ENDING	NO. OF VEHICLES IN QUEUE
08.00	0.3
08.15	0.4
08.30	0.6 *
08.45	0.6 *
09.00	0.4
09.15	0.3

QUEUE FOR STREAM B-A

TIME SEGMENT ENDING	NO. OF VEHICLES IN QUEUE
08.00	0.3
08.15	0.4
08.30	0.7 *
08.45	0.7 *
09.00	0.5
09.15	0.3

QUEUE FOR STREAM C-B

TIME SEGMENT ENDING	NO. OF VEHICLES IN QUEUE
08.00	0.1
08.15	0.1
08.30	0.2
08.45	0.2
09.00	0.1
09.15	0.1

QUEUEING DELAY INFORMATION OVER WHOLE PERIOD

STREAM	TOTAL DEMAND	* QUEUEING * * DELAY *	* INCLUSIVE QUEUEING * * DELAY *
(VEH)	(VEH/H)	(MIN)	(MIN/VEH)
B-C	271.2	40.5	0.15
B-A	231.2	42.9	0.19
C-A	318.0		
C-B	112.9	12.3	0.11
A-B	137.6		
A-C	282.2		
ALL	1353.0	95.7	0.07

* DELAY IS THAT OCCURRING ONLY WITHIN THE TIME PERIOD
 * INCLUSIVE DELAY INCLUDES DELAY SUFFERED BY VEHICLES
 WHICH ARE STILL QUEUEING AFTER THE END OF THE TIME PERIOD
 * THESE WILL ONLY BE SIGNIFICANTLY DIFFERENT IF THERE IS
 A LARGE QUEUE REMAINING AT THE END OF THE TIME PERIOD.

*****END OF RUN*****

==== end of file =====

TRL LIMITED

(C) COPYRIGHT 2006

CAPACITIES, QUEUES, AND DELAYS AT 3 OR 4-ARM MAJOR/MINOR PRIORITY JUNCTIONS

PICADY 5.1 ANALYSIS PROGRAM
RELEASE 4.0 (SEPT 2008)

ADAPTED FROM PICADY/3 WHICH IS CROWN COPYRIGHT
BY PERMISSION OF THE CONTROLLER OF HMSO

FOR SALES AND DISTRIBUTION INFORMATION,
PROGRAM ADVICE AND MAINTENANCE CONTACT:
TRL SOFTWARE BUREAU
TEL: CROWTHORNE (01344) 770758, FAX: 770356
EMAIL: Software@trl.co.uk

THE USER OF THIS COMPUTER PROGRAM FOR THE SOLUTION OF AN ENGINEERING PROBLEM IS
IN NO WAY RELIEVED OF HIS/HER RESPONSIBILITY FOR THE CORRECTNESS OF THE SOLUTION

Run with file:-
"Z:\Stomor Ltd\2100 Projects\2189-Hemel Hempstead- Land at Fields End\PICADY\Junction 1\PM-Peak-2031.vpi"
(drive-on-the-left) at 09:30:16 on Wednesday, 23 May 2012

RUN INFORMATION

RUN TITLE : PM Peak 0800-0900 - 2012- Existing plus 900 house development plus school
LOCATION : Junction of Long Chaulden with Site Access
DATE : 17/05/12
CLIENT : Taylor Wimpey
ENUMERATOR : duncan [DUNCAN]
JOB NUMBER : ST-2189
STATUS : TIA
DESCRIPTION : Year 2031 - Junction of Long Chaulden with Site Access AM 0800-0900
- Existing traffic flows plus 900 house development plus school,
with ODTAB table.

MAJOR/MINOR JUNCTION CAPACITY AND DELAY

INPUT DATA

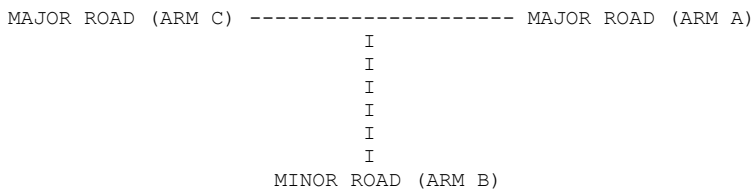

ARM A IS Long Chaulden South
ARM B IS Site Access
ARM C IS Long Chaulden North

STREAM LABELLING CONVENTION

STREAM A-B CONTAINS TRAFFIC GOING FROM ARM A TO ARM B
STREAM B-AC CONTAINS TRAFFIC GOING FROM ARM B TO ARM A AND TO ARM C
ETC.

 GEOMETRIC DATA

I	DATA ITEM	I	MINOR ROAD B	I
I	TOTAL MAJOR ROAD CARRIAGEWAY WIDTH	I	(W) 7.00 M.	I
I	CENTRAL RESERVE WIDTH	I	(WCR) 0.00 M.	I
I	MAJOR ROAD RIGHT TURN - WIDTH	I	(WC-B) 3.00 M.	I
I	- VISIBILITY	I	(VC-B) 120.00 M.	I
I	- BLOCKS TRAFFIC	I	NO	I
I	MINOR ROAD - VISIBILITY TO LEFT	I	(VB-C) 90.0 M.	I
I	- VISIBILITY TO RIGHT	I	(VB-A) 45.0 M.	I
I	- LANE 1 WIDTH	I	(WB-C) -	I
I	- LANE 2 WIDTH	I	(WB-A) -	I
I	WIDTH AT 0 M FROM JUNCTION	I	10.00 M.	I
I	WIDTH AT 5 M FROM JUNCTION	I	4.00 M.	I
I	WIDTH AT 10 M FROM JUNCTION	I	3.34 M.	I
I	WIDTH AT 15 M FROM JUNCTION	I	3.34 M.	I
I	WIDTH AT 20 M FROM JUNCTION	I	3.34 M.	I
I	- LENGTH OF FLARED SECTION	I	1 VEHS	I

 .SLOPES AND INTERCEPT

(NB:Streams may be combined, in which case capacity will be adjusted)

I	Intercept For	Slope For	Opposing	Slope For	Opposing	I
I	STREAM B-C	STREAM	A-C	STREAM	A-B	I
I	0.00	0.00	0.00	0.00	0.00	I

* Due to the presence of a flare, data is not available

I	Intercept For	Slope For	Opposing	Slope For	Opposing	Slope For	Opposing	Slope For	Opposing	I
I	STREAM B-A	STREAM	A-C	STREAM	A-B	STREAM	C-A	STREAM	C-B	I
I	0.00	0.00	0.00	0.00	0.00	0.00	0.00	0.00	0.00	I

* Due to the presence of a flare, data is not available

I	Intercept For	Slope For	Opposing	Slope For	Opposing	I
I	STREAM C-B	STREAM	A-C	STREAM	A-B	I
I	699.48	0.26	0.26	0.26	0.26	I

(NB These values do not allow for any site specific corrections)

 TRAFFIC DEMAND DATA

I	ARM	I	FLOW SCALE (%)	I
I	A	I	100	I
I	B	I	100	I
I	C	I	100	I

Demand set: AM Flows0800 -0900

TIME PERIOD BEGINS 16.45 AND ENDS 18.15

LENGTH OF TIME PERIOD - 90 MIN.
 LENGTH OF TIME SEGMENT - 15 MIN.

DEMAND FLOW PROFILES ARE SYNTHESISED FROM TURNING COUNT DATA

		NUMBER OF MINUTES FROM START WHEN			RATE OF FLOW (VEH/MIN)		
ARM		FLOW STARTS	TOP OF PEAK	FLOW STOPS	BEFORE	AT TOP	AFTER
		TO RISE	IS REACHED	FALLING	PEAK	OF PEAK	PEAK
ARM A	I	15.00	I 45.00	I 75.00	I 4.34	I 6.51	I 4.34
ARM B	I	15.00	I 45.00	I 75.00	I 1.95	I 2.93	I 1.95
ARM C	I	15.00	I 45.00	I 75.00	I 4.72	I 7.09	I 4.72

Demand set: AM Flows0800 -0900

		TURNING PROPORTIONS						
		TURNING COUNTS						
		(PERCENTAGE OF H.V.S)						
TIME	FROM/TO	ARM	A	ARM	B	ARM	C	
16.45 - 17.00	ARM A	0.000	0.329	0.671	0.0	114.0	233.0	
		(0.0)	(0.0)	(0.0)				
	ARM B	0.462	0.000	0.538	72.0	0.0	84.0	
		(0.0)	(0.0)	(0.0)				
	ARM C	0.653	0.347	0.000	247.0	131.0	0.0	
		(1.6)	(0.0)	(0.0)				
17.00 - 17.15	ARM A	0.000	0.329	0.671	0.0	0.0	0.0	
		(0.0)	(0.0)	(0.0)				
	ARM B	0.462	0.000	0.538	0.0	0.0	0.0	
		(0.0)	(0.0)	(0.0)				
	ARM C	0.653	0.347	0.000	0.0	0.0	0.0	
		(0.0)	(0.0)	(0.0)				
17.15 - 17.30	ARM A	0.000	0.329	0.671	0.0	0.0	0.0	
		(0.0)	(0.0)	(0.0)				
	ARM B	0.462	0.000	0.538	0.0	0.0	0.0	
		(0.0)	(0.0)	(0.0)				
	ARM C	0.653	0.347	0.000	0.0	0.0	0.0	
		(0.0)	(0.0)	(0.0)				
17.30 - 17.45	ARM A	0.000	0.329	0.671	0.0	0.0	0.0	
		(0.0)	(0.0)	(0.0)				
	ARM B	0.462	0.000	0.538	0.0	0.0	0.0	
		(0.0)	(0.0)	(0.0)				
	ARM C	0.653	0.347	0.000	0.0	0.0	0.0	
		(0.0)	(0.0)	(0.0)				
17.45 - 18.00	ARM A	0.000	0.329	0.671	0.0	0.0	0.0	
		(0.0)	(0.0)	(0.0)				
	ARM B	0.462	0.000	0.538	0.0	0.0	0.0	
		(0.0)	(0.0)	(0.0)				
	ARM C	0.653	0.347	0.000	0.0	0.0	0.0	
		(0.0)	(0.0)	(0.0)				
18.00 - 18.15	ARM A	0.000	0.329	0.671	0.0	0.0	0.0	
		(0.0)	(0.0)	(0.0)				
	ARM B	0.462	0.000	0.538	0.0	0.0	0.0	
		(0.0)	(0.0)	(0.0)				
	ARM C	0.653	0.347	0.000	0.0	0.0	0.0	
		(0.0)	(0.0)	(0.0)				

TIME	DEMAND (VEH/MIN)	CAPACITY (VEH/MIN)	DEMAND/ CAPACITY (RFC)	PEDESTRIAN FLOW (PEDS/MIN)	START QUEUE (VEHS)	END QUEUE (VEHS)	DELAY (VEH.MIN/ TIME SEGMENT)	GEOMETRIC DELAY (VEH.MIN/ TIME SEGMENT)	AVERAGE DELAY PER ARRIVING VEHICLE (MIN)
18.00-18.15									
B-C	1.05	10.54	0.100		0.14	0.11	1.7		0.11
B-A	0.90	8.39	0.108		0.16	0.12	1.9		0.13
C-A	3.10								
C-B	1.64	10.53	0.156		0.24	0.19	2.9		0.11
A-B	1.43								
A-C	2.92								

QUEUE FOR STREAM B-C

TIME SEGMENT ENDING	NO. OF VEHICLES IN QUEUE
17.00	0.1
17.15	0.1
17.30	0.2
17.45	0.2
18.00	0.1
18.15	0.1

QUEUE FOR STREAM B-A

TIME SEGMENT ENDING	NO. OF VEHICLES IN QUEUE
17.00	0.1
17.15	0.2
17.30	0.2
17.45	0.2
18.00	0.2
18.15	0.1

QUEUE FOR STREAM C-B

TIME SEGMENT ENDING	NO. OF VEHICLES IN QUEUE
17.00	0.2
17.15	0.2
17.30	0.3
17.45	0.3
18.00	0.2
18.15	0.2

QUEUEING DELAY INFORMATION OVER WHOLE PERIOD

STREAM	TOTAL DEMAND (VEH)	TOTAL DEMAND (VEH/H)	* QUEUEING * (MIN)	* QUEUEING * (MIN/VEH)	* INCLUSIVE QUEUEING * (MIN)	* INCLUSIVE QUEUEING * (MIN/VEH)
B-C	115.6	77.1	12.9	0.11	12.9	0.11
B-A	99.1	66.1	14.7	0.15	14.7	0.15
C-A	340.0	226.7				
C-B	180.3	120.2	21.9	0.12	21.9	0.12
A-B	156.9	104.6				
A-C	320.7	213.8				
ALL	1212.6	808.4	49.5	0.04	49.5	0.04

* DELAY IS THAT OCCURRING ONLY WITHIN THE TIME PERIOD
 * INCLUSIVE DELAY INCLUDES DELAY SUFFERED BY VEHICLES WHICH ARE STILL QUEUEING AFTER THE END OF THE TIME PERIOD
 * THESE WILL ONLY BE SIGNIFICANTLY DIFFERENT IF THERE IS A LARGE QUEUE REMAINING AT THE END OF THE TIME PERIOD.

*****END OF RUN*****

==== end of file =====



ARCADY 7

Version: 7.0.0.99 [10 July 2009]
© Copyright Transport Research Laboratory 2009

For sales and distribution information, program advice and maintenance, contact TRL:
Tel: +44 (0)1344 770758 E-mail: software@trl.co.uk Web: www.trlsoftware.co.uk

The users of this computer program for the solution of an engineering problem are in no way relieved of their responsibility for the correctness of the solution

File: Z:\Stomor Ltd\2100 Projects\2189-Hemel Hempstead- Land at Fields End\ARCADY\Junction 2\Junction 2-2031-AM+Growth+Dev..arc7
Report generation date: 10/05/2012 12:06:50

File summary

File Description

Title	Boxted Road/The Avenue Roundabout
Location	Hemel Hempstead
Site Number	ST-2189
Date	10/05/2012
Status	(new file)
Client	Taylor Wimpey Strategic Land
Jobnumber	ST-2189
Enumerator	STOMORLTD\duncan
Description	AM Peak Hour 2031 +Growth+Development
Results Upto Date	True

Analysis Options

RFC Threshold	Vehicle Length (m)	Do Queue Variations
0.85	5.75	

Sorting and Display

Show Arm Names	Arm Grouping	Sorting Direction	Sorting Type	Data Matrix Style	Time Style
Yes	Order	Ascending	Numerical	By Destination	Absolute Time

Units

Distance Units	Speed Units	Traffic Units Input	Traffic Units Results	Flow Units	Average Delay Units	Total Delay Units	Rate Of Delay Units
m	kph	Veh	Veh	perHour	min	-Min	perMin

A2 - (Default Analysis Set) - D1 - Existing 2012, AM 0800 - 0 00

Data Errors and Warnings

No errors or warnings

Analysis Set Details

Name	Description	Include In Report	Use Specific Demand Set	Demand Set	Locked	Network Flow Scaling Factor (%)	Network Capacity Scaling Factor (%)	Reason For Scaling Factors
(Default Analysis Set)		Yes		(D1)		100.000	100.000	

Demand Set Details

Name	Scenario Name	Time Period Name	Description	Locked	Run Automatically	Use Relationship	Relationship	Start Time (HH:mm)	Finish Time (HH:mm)	Time Period Length	Time Segment Length	Traffic Profile Type
------	---------------	------------------	-------------	--------	-------------------	------------------	--------------	--------------------	---------------------	--------------------	---------------------	----------------------

Existing 2012, AM 0800 - 0900	Existing 2012	AM 0800 - 0900	Peak Hour Flows		Yes			07:45	09:15	90	15	ONE HOUR
-------------------------------	---------------	----------------	-----------------	--	-----	--	--	-------	-------	----	----	----------

Roundabout Network

Roundabout Type(s)

ID	Name	Arm Order	Roundabout Type	Grade Separated	Large Roundabout	Do Geometric Delay
1	Boxted Road/The Avenue Roundabout	1,2,3,4	Standard			

Roundabout Network Options

Driving Side	Lighting	Road Surface	In London
Left	Normal/unknown	((Mini-roundabouts only))	

Arms

Arms

ID	Name	Description
1	Boxted Road North	Single Carriageway
2	Warmark Road	Single Carriageway
3	Boxted Road South	Single Carriageway
4	The Avenue	Single Carriageway

Capacity Options

Arm	Minimum Capacity (PCU/hr)	Maximum Capacity (PCU/hr)	Assume Flat Start Profile	Initial Queue (PCU)
Boxted Road North	0.00	99999.00		0.00
Warmark Road	0.00	99999.00		0.00
Boxted Road South	0.00	99999.00		0.00
The Avenue	0.00	99999.00		0.00

Standard Geometry

Arm	V - Approach road half-width (m)	E - Entry width (m)	I' - Effective flare length (m)	R - Entry radius (m)	D - Inscribed circle diameter (m)	PHI - Conflict (entry) angle (deg)	Exit Only
Boxted Road North	3.40	5.00	6.00	10.00	24.00	31.00	
Warmark Road	2.50	3.80	3.50	13.50	24.50	27.50	
Boxted Road South	3.50	4.50	9.00	20.00	24.00	19.00	
The Avenue	3.45	5.10	12.00	29.00	24.50	17.00	

Pedestrian Crossings

Arm	Crossing Type
Boxted Road North	None
Warmark Road	None
Boxted Road South	None
The Avenue	None

Arm Slope/ Intercept and Capacity

Slope and Intercept used in model

Arm	Enter Directly	Slope	Intercept (PCU/hr)	Final Slope	Final Intercept (PCU/hr)
Boxted Road North		((calculated))	((calculated))	0.548	1224.132
Warmark Road		((calculated))	((calculated))	0.498	923.541
Boxted Road South		((calculated))	((calculated))	0.599	1333.036
The Avenue		((calculated))	((calculated))	0.635	1476.488

The slope and intercept shown above include any corrections and adjustments.

Traffic Flows

Demand Set Data Options

Default Vehicle Mix	Vehicle Mix Varies Over Time	Vehicle Mix Varies Over Turn	Vehicle Mix Varies Over Entry	Vehicle Mix Source	PCU Factor for a HV (PCU)	Default Turning Proportions	Estimate from entry/exit counts	Turning Proportions Vary Over Time	Turning Proportions Vary Over Turn	Turning Proportions Vary Over Entry
	Yes	Yes	Yes	HV Percentages	2.00				Yes	Yes

Entry Flows

General Flows Data

Arm	Profile Type	Use Turning Counts	Average Demand Flow (Veh/hr)	Flow Scaling Factor (%)	PHF
Boxted Road North	ONE HOUR	Yes	470.00	100.000	N/A
Warmark Road	ONE HOUR	Yes	18.00	100.000	N/A
Boxted Road South	ONE HOUR	Yes	462.00	100.000	N/A
The Avenue	ONE HOUR	Yes	359.00	100.000	N/A

Direct/Resultant Flows

Direct Flows Data

Time Segment	Arm	Direct Demand Entry Flow (Veh/hr)	DirectDemandEntryFlowInPCU (PCU/hr)	Direct Demand Exit Flow (Veh/hr)	Direct Demand Pedestrian Flow (Ped/hr)
07:45-08:00	Boxted Road North	353.84	359.14	N/A	N/A
07:45-08:00	Warmark Road	13.55	13.55	N/A	N/A
07:45-08:00	Boxted Road South	347.82	359.11	N/A	N/A
07:45-08:00	The Avenue	270.27	271.03	N/A	N/A
08:00-08:15	Boxted Road North	422.52	448.41	N/A	N/A
08:00-08:15	Warmark Road	16.18	18.05	N/A	N/A
08:00-08:15	Boxted Road South	415.33	479.59	N/A	N/A
08:00-08:15	The Avenue	322.73	351.40	N/A	N/A
08:15-08:30	Boxted Road North	517.48	549.19	N/A	N/A
08:15-08:30	Warmark Road	19.82	22.11	N/A	N/A
08:15-08:30	Boxted Road South	508.67	587.38	N/A	N/A
08:15-08:30	The Avenue	395.27	430.37	N/A	N/A
08:30-08:45	Boxted Road North	517.48	549.19	N/A	N/A
08:30-08:45	Warmark Road	19.82	22.11	N/A	N/A
08:30-08:45	Boxted Road South	508.67	587.38	N/A	N/A
08:30-08:45	The Avenue	395.27	430.37	N/A	N/A
08:45-0 :00	Boxted Road North	422.52	444.05	N/A	N/A
08:45-0 :00	Warmark Road	16.18	16.99	N/A	N/A
08:45-0 :00	Boxted Road South	415.33	435.92	N/A	N/A
08:45-0 :00	The Avenue	322.73	338.87	N/A	N/A
0 :00-0 :15	Boxted Road North	353.84	371.87	N/A	N/A
0 :00-0 :15	Warmark Road	13.55	14.23	N/A	N/A
0 :00-0 :15	Boxted Road South	347.82	365.06	N/A	N/A
0 :00-0 :15	The Avenue	270.27	283.79	N/A	N/A

Turning Proportions

Turning Counts or Proportions (Veh/hr) - Roundabout 1 (for whole period)

		To			
		1	2	3	4
1	1.00	1.00	443.00	25.00	

	2	8.00	0.00	9.00	1.00
From	3	377.00	4.00	4.00	77.00
	4	72.00	0.00	287.00	0.00

Turning Proportions (Veh) - Roundabout 1 (for whole period)

		To			
		1	2	3	4
From	1	0.00	0.00	0.94	0.05
	2	0.44	0.00	0.50	0.06
	3	0.82	0.01	0.01	0.17
	4	0.20	0.00	0.80	0.00

Vehicle Mix

Average PCU Per Vehicle - Roundabout 1 - (07:45-08:00)

		To			
		1	2	3	4
From	1	1.00	1.00	1.02	1.00
	2	1.00	1.00	1.00	1.00
	3	1.04	1.00	1.00	1.00
	4	1.01	1.00	1.00	1.00

Heavy Vehicle Percentages - Roundabout 1 - (07:45-08:00)

		To			
		1	2	3	4
From	1	0.00	0.00	1.59	0.00
	2	0.00	0.00	0.00	0.00
	3	3.98	0.00	0.00	0.00
	4	1.40	0.00	0.00	0.00

Average PCU Per Vehicle - Roundabout 1 - (08:00-08:15)

		To			
		1	2	3	4
From	1	1.00	1.00	1.06	1.04
	2	1.09	1.00	1.15	1.03
	3	1.15	1.00	1.00	1.19
	4	1.08	1.00	1.09	1.00

Heavy Vehicle Percentages - Roundabout 1 - (08:00-08:15)

		To			
		1	2	3	4
From	1	0.00	0.00	6.25	4.45
	2	8.85	0.00	15.00	2.50
	3	15.00	0.00	0.00	19.40
	4	7.69	0.00	9.18	0.00

Average PCU Per Vehicle - Roundabout 1 - (08:15-08:30)

		To			
		1	2	3	4
From	1	1.00	1.00	1.06	1.04
	2	1.09	1.00	1.15	1.03
	3	1.15	1.00	1.00	1.19
	4	1.08	1.00	1.09	1.00

Heavy Vehicle Percentages - Roundabout 1 - (08:15-08:30)

		To			
		1	2	3	4
	1	0.00	0.00	6.25	4.45

	2	8.85	0.00	15.00	2.50
From	3	15.00	0.00	0.00	19.40
	4	7.69	0.00	9.18	0.00

Average PCU Per Vehicle - Roundabout 1 - (08:30-08:45)

		To			
		1	2	3	4
From	1	1.00	1.00	1.06	1.04
	2	1.09	1.00	1.15	1.03
	3	1.15	1.00	1.00	1.19
	4	1.08	1.00	1.09	1.00

Heavy Vehicle Percentages - Roundabout 1 - (08:30-08:45)

		To			
		1	2	3	4
From	1	0.00	0.00	6.25	4.45
	2	8.85	0.00	15.00	2.50
	3	15.00	0.00	0.00	19.40
	4	7.69	0.00	9.18	0.00

Average PCU Per Vehicle - Roundabout 1 - (08:45-0 :00)

		To			
		1	2	3	4
From	1	1.00	1.55	1.05	1.05
	2	1.05	1.00	1.05	1.05
	3	1.05	1.05	1.00	1.05
	4	1.05	1.05	1.05	1.00

Heavy Vehicle Percentages - Roundabout 1 - (08:45-0 :00)

		To			
		1	2	3	4
From	1	0.00	55.00	5.00	5.00
	2	5.00	0.00	5.00	5.00
	3	5.00	5.00	0.00	5.00
	4	5.00	5.00	5.00	0.00

Average PCU Per Vehicle - Roundabout 1 - (0 :00-0 :15)

		To			
		1	2	3	4
From	1	1.00	1.55	1.05	1.05
	2	1.05	1.00	1.05	1.05
	3	1.05	1.05	1.00	1.05
	4	1.05	1.05	1.05	1.00

Heavy Vehicle Percentages - Roundabout 1 - (0 :00-0 :15)

		To			
		1	2	3	4
From	1	0.00	55.00	5.00	5.00
	2	5.00	0.00	5.00	5.00
	3	5.00	5.00	0.00	5.00
	4	5.00	5.00	5.00	0.00

Results

Results Summary

Arm	Max RFC	Max Delay (min)	Max Queue (Veh)	Max LOS	Total Demand (Veh/hr)	Total Arrivals (Veh)	Total Queueing Delay (Veh-min)	Average Queueing Delay (min)	Rate Of Queueing Delay (Veh-	Inclusive Queueing Total Delay	Inclusive Queueing Average Delay	Slope	Intercept (PCU/hr)
-----	---------	-----------------	-----------------	---------	-----------------------	----------------------	--------------------------------	------------------------------	------------------------------	--------------------------------	----------------------------------	-------	--------------------

									min/min)	(Veh-min)	(min)		
Boxted Road North	0.53	0.13	1.14	A	431.19	646.79	69.64	0.11	0.77	69.64	0.11	0.548	1224.132
Warmark Road	0.05	0.15	0.05	A	16.49	24.74	3.07	0.12	0.03	3.07	0.12	0.498	923.541
Boxted Road South	0.45	0.10	0.84	A	422.86	634.30	51.47	0.08	0.57	51.47	0.08	0.599	1333.036
The Avenue	0.37	0.09	0.60	A	329.16	493.74	37.41	0.08	0.42	37.41	0.08	0.635	1476.488

Main Results

Main results: (07:45-08:00)

Arm	Demand (Veh/hr)	Arrivals (Veh)	Entry Flow (Veh/hr)	Exit Flow (Veh/hr)	Circulating Flow (Veh/hr)	Pedestrian Demand (Ped/hr)	Capacity (Veh/hr)	Saturation Capacity (Veh/hr)	RFC	Start Queue (Veh)	End Queue (Veh)
Boxted Road North	353.84	88.46	351.92	343.33	221.21	0.00	1086.59	868.10	0.326	0.00	0.48
Warmark Road	13.55	3.39	13.47	3.75	569.39	0.00	637.55	179.74	0.021	0.00	0.02
Boxted Road South	347.82	86.95	346.33	556.66	26.20	0.00	1275.90	1211.12	0.273	0.00	0.37
The Avenue	270.27	67.57	269.21	77.19	295.34	0.00	1278.21	756.57	0.211	0.00	0.27

Main results: (08:00-08:15)

Arm	Demand (Veh/hr)	Arrivals (Veh)	Entry Flow (Veh/hr)	Exit Flow (Veh/hr)	Circulating Flow (Veh/hr)	Pedestrian Demand (Ped/hr)	Capacity (Veh/hr)	Saturation Capacity (Veh/hr)	RFC	Start Queue (Veh)	End Queue (Veh)
Boxted Road North	422.60	105.65	421.56	410.94	264.75	0.00	1004.73	825.94	0.421	0.46	0.72
Warmark Road	16.19	4.05	16.13	4.49	681.82	0.00	501.88	158.92	0.032	0.02	0.03
Boxted Road South	415.47	103.87	414.52	666.57	31.39	0.00	1137.67	1085.54	0.365	0.33	0.57
The Avenue	322.81	80.70	322.19	92.41	353.50	0.00	1120.26	705.51	0.288	0.25	0.40

Main results: (08:15-08:30)

Arm	Demand (Veh/hr)	Arrivals (Veh)	Entry Flow (Veh/hr)	Exit Flow (Veh/hr)	Circulating Flow (Veh/hr)	Pedestrian Demand (Ped/hr)	Capacity (Veh/hr)	Saturation Capacity (Veh/hr)	RFC	Start Queue (Veh)	End Queue (Veh)
Boxted Road North	517.48	129.37	515.87	503.32	324.21	0.00	971.05	825.78	0.533	0.72	1.12
Warmark Road	19.82	4.95	19.76	5.49	834.58	0.00	428.48	158.84	0.046	0.03	0.05
Boxted Road South	508.67	127.17	507.73	815.92	38.42	0.00	1133.43	1085.16	0.449	0.57	0.81
The Avenue	395.27	98.82	394.54	113.16	432.99	0.00	1066.83	705.34	0.371	0.40	0.58

Main results: (08:30-08:45)

Arm	Demand (Veh/hr)	Arrivals (Veh)	Entry Flow (Veh/hr)	Exit Flow (Veh/hr)	Circulating Flow (Veh/hr)	Pedestrian Demand (Ped/hr)	Capacity (Veh/hr)	Saturation Capacity (Veh/hr)	RFC	Start Queue (Veh)	End Queue (Veh)
Boxted Road North	517.48	129.37	517.44	504.25	324.79	0.00	970.72	825.78	0.533	1.12	1.13
Warmark Road	19.82	4.95	19.82	5.50	836.73	0.00	427.46	158.84	0.046	0.05	0.05
Boxted Road South	508.67	127.17	508.65	818.01	38.53	0.00	1133.37	1085.16	0.449	0.81	0.81
The Avenue	395.27	98.82	395.25	113.40	433.79	0.00	1066.30	705.34	0.371	0.58	0.59

Main results: (08:45-0 :00)

Arm	Demand (Veh/hr)	Arrivals (Veh)	Entry Flow (Veh/hr)	Exit Flow (Veh/hr)	Circulating Flow (Veh/hr)	Pedestrian Demand (Ped/hr)	Capacity (Veh/hr)	Saturation Capacity (Veh/hr)	RFC	Start Queue (Veh)	End Queue (Veh)
Boxted Road North	422.48	105.62	424.18	412.92	265.88	0.00	1019.12	835.46	0.415	1.14	0.72
Warmark Road	16.17	4.04	16.25	4.51	685.55	0.00	538.01	170.48	0.030	0.05	0.03
Boxted Road South	414.98	103.74	416.53	670.21	31.59	0.00	1250.12	1190.32	0.332	0.89	0.50
The Avenue	322.64	80.66	323.56	92.89	355.24	0.00	1180.23	726.63	0.273	0.61	0.38

Main results: (0 :00-0 :15)

Arm	Demand (Veh/hr)	Arrivals (Veh)	Entry Flow (Veh/hr)	Exit Flow (Veh/hr)	Circulating Flow (Veh/hr)	Pedestrian Demand (Ped/hr)	Capacity (Veh/hr)	Saturation Capacity (Veh/hr)	RFC	Start Queue (Veh)	End Queue (Veh)
Boxted Road North	353.84	88.46	354.63	345.27	222.39	0.00	1043.07	835.55	0.339	0.72	0.52
Warmark Road	13.55	3.39	13.58	3.77	573.26	0.00	594.36	170.61	0.023	0.03	0.02
Boxted Road South	347.82	86.95	348.28	560.43	26.41	0.00	1254.28	1191.33	0.277	0.50	0.39
The Avenue	270.27	67.57	270.64	77.66	297.02	0.00	1217.68	726.83	0.222	0.38	0.29

Queueing Delay Results

Queueing Delay results: (07:45-08:00)

Arm	Queueing Total Delay (Veh-min)	Queueing Rate Of Delay (Veh-min/min)	Average Delay Per Arriving Vehicle (min)	Unsignalised Level Of Service	Signalised Level Of Service
Boxted Road North	6.97	0.46	0.081	A	A
Warmark Road	0.32	0.02	0.096	A	A
Boxted Road South	5.45	0.36	0.064	A	A
The Avenue	3.92	0.26	0.059	A	A

Queueing Delay results: (08:00-08:15)

Arm	Queueing Total Delay (Veh-min)	Queueing Rate Of Delay (Veh-min/min)	Average Delay Per Arriving Vehicle (min)	Unsignalised Level Of Service	Signalised Level Of Service
Boxted Road North	10.44	0.70	0.103	A	A
Warmark Road	0.48	0.03	0.124	A	A
Boxted Road South	8.34	0.56	0.083	A	A
The Avenue	5.90	0.39	0.075	A	A

Queueing Delay results: (08:15-08:30)

Arm	Queueing Total Delay (Veh-min)	Queueing Rate Of Delay (Veh-min/min)	Average Delay Per Arriving Vehicle (min)	Unsignalised Level Of Service	Signalised Level Of Service
Boxted Road North	16.15	1.08	0.131	A	A
Warmark Road	0.70	0.05	0.147	A	A
Boxted Road South	11.75	0.78	0.096	A	A
The Avenue	8.53	0.57	0.089	A	A

Queueing Delay results: (08:30-08:45)

Arm	Queueing Total Delay (Veh-min)	Queueing Rate Of Delay (Veh-min/min)	Average Delay Per Arriving Vehicle (min)	Unsignalised Level Of Service	Signalised Level Of Service
Boxted Road North	16.90	1.13	0.132	A	A
Warmark Road	0.72	0.05	0.147	A	A
Boxted Road South	12.12	0.81	0.096	A	A
The Avenue	8.78	0.59	0.089	A	A

Queueing Delay results: (08:45-0 :00)

Arm	Queueing Total Delay (Veh-min)	Queueing Rate Of Delay (Veh-min/min)	Average Delay Per Arriving Vehicle (min)	Unsignalised Level Of Service	Signalised Level Of Service
Boxted Road North	11.10	0.74	0.101	A	A
Warmark Road	0.48	0.03	0.115	A	A
Boxted Road South	7.70	0.51	0.072	A	A
The Avenue	5.81	0.39	0.070	A	A

Queueing Delay results: (0 :00-0 :15)

Arm	Queueing Total Delay (Veh-min)	Queueing Rate Of Delay (Veh-min/min)	Average Delay Per Arriving Vehicle (min)	Unsignalised Level Of Service	Signalised Level Of Service
Boxted Road North	7.96	0.53	0.087	A	A
Warmark Road	0.36	0.02	0.103	A	A
Boxted Road South	5.89	0.39	0.066	A	A
The Avenue	4.37	0.29	0.063	A	A

Overview: Standard Roundabout Geometry

Standard Geometry

Arm	V - Approach road half-width (m)	E - Entry width (m)	I' - Effective flare length (m)	R - Entry radius (m)	D - Inscribed circle diameter (m)	PHI - Conflict (entry) angle (deg)	Exit Only	Final Slope	Final Intercept (PCU/hr)
Boxted Road North	3.40	5.00	6.00	10.00	24.00	31.00		0.548	1224.132
Warmark Road	2.50	3.80	3.50	13.50	24.50	27.50		0.498	923.541
Boxted Road South	3.50	4.50	9.00	20.00	24.00	19.00		0.599	1333.036
The Avenue	3.45	5.10	12.00	29.00	24.50	17.00		0.635	1476.488

Overview: Time Segment Results

Time Segment Results

Time Segment	Arm	Demand (Veh/hr)	Capacity (Veh/hr)	RFC	Pedestrian Demand (Ped/hr)	Start Queue (Veh)	End Queue (Veh)	Queueing Total Delay (Veh-min)	Geometric Total Delay (Veh-min)	Average Delay Per Arriving Vehicle (min)
07:45-08:00	Boxted Road North	353.84	1086.59	0.326	0.00	0.00	0.48	6.97	(16.22)	0.081
07:45-08:00	Warmark Road	13.55	637.55	0.021	0.00	0.00	0.02	0.32	(22.65)	0.096
07:45-08:00	Boxted Road South	347.82	1275.90	0.273	0.00	0.00	0.37	5.45	(18.25)	0.064
07:45-08:00	The Avenue	270.27	1278.21	0.211	0.00	0.00	0.27	3.92	(16.55)	0.059
08:00-08:15	Boxted Road North	422.60	1004.73	0.421	0.00	0.46	0.72	10.44	(15.51)	0.103
08:00-08:15	Warmark Road	16.19	501.88	0.032	0.00	0.02	0.03	0.48	(20.31)	0.124
08:00-08:15	Boxted Road South	415.47	1137.67	0.365	0.00	0.33	0.57	8.34	(16.32)	0.083
08:00-08:15	The Avenue	322.81	1120.26	0.288	0.00	0.25	0.40	5.90	(15.25)	0.075
08:15-08:30	Boxted Road North	517.48	971.05	0.533	0.00	0.72	1.12	16.15	(15.51)	0.131
08:15-08:30	Warmark Road	19.82	428.48	0.046	0.00	0.03	0.05	0.70	(20.30)	0.147
08:15-08:30	Boxted Road South	508.67	1133.43	0.449	0.00	0.57	0.81	11.75	(16.32)	0.096
08:15-08:30	The Avenue	395.27	1066.83	0.371	0.00	0.40	0.58	8.53	(15.24)	0.089
08:30-08:45	Boxted Road North	517.48	970.72	0.533	0.00	1.12	1.13	16.90	(15.51)	0.132
08:30-08:45	Warmark Road	19.82	427.46	0.046	0.00	0.05	0.05	0.72	(20.30)	0.147
08:30-08:45	Boxted Road South	508.67	1133.37	0.449	0.00	0.81	0.81	12.12	(16.32)	0.096
08:30-08:45	The Avenue	395.27	1066.30	0.371	0.00	0.58	0.59	8.78	(15.24)	0.089
08:45-0 :00	Boxted Road North	422.48	1019.12	0.415	0.00	1.14	0.72	11.10	(15.66)	0.101
08:45-0 :00	Warmark Road	16.17	538.01	0.030	0.00	0.05	0.03	0.48	(21.56)	0.115
08:45-0 :00	Boxted Road South	414.98	1250.12	0.332	0.00	0.89	0.50	7.70	(17.94)	0.072
08:45-0 :00	The Avenue	322.64	1180.23	0.273	0.00	0.61	0.38	5.81	(15.80)	0.070
0 :00-0 :15	Boxted Road North	353.84	1043.07	0.339	0.00	0.72	0.52	7.96	(15.66)	0.087
0 :00-0 :15	Warmark Road	13.55	594.36	0.023	0.00	0.03	0.02	0.36	(21.58)	0.103
0 :00-0 :15	Boxted Road South	347.82	1254.28	0.277	0.00	0.50	0.39	5.89	(17.95)	0.066
0 :00-0 :15	The Avenue	270.27	1217.68	0.222	0.00	0.38	0.29	4.37	(15.81)	0.063

ARCADY 7

Version: 7.0.0.99 [10 July 2009]

© Copyright Transport Research Laboratory 2009

For sales and distribution information, program advice and maintenance, contact TRL:
Tel: +44 (0)1344 770758 E-mail: software@trl.co.uk Web: www.trlsoftware.co.uk

The users of this computer program for the solution of an engineering problem are in no way relieved of their responsibility for the correctness of the solution

File: Z:\Stomor Ltd\2100 Projects\2189-Hemel Hempstead- Land at Fields End\ARCADY\Junction 2\Junction 2-2031-PM Growth+Dev..arc7
Report generation date: 10/05/2012 12:20:57

File summary

File Description

Title	Boxted Road/The Avenue Roundabout
Location	Hemel Hempstead
Site Number	ST-2189
Date	10/05/2012
Status	(new file)
Client	Taylor Wiompey Strategic Land
Jobnumber	ST-2189
Enumerator	STOMORLTD\duncan
Description	PM Peak Hour 2031 Growth+Development
Results Upto Date	True

Analysis Options

RFC Threshold	Vehicle Length (m)	Do Queue Variations
0.85	5.75	

Sorting and Display

Show Arm Names	Arm Grouping	Sorting Direction	Sorting Type	Data Matrix Style	Time Style
Yes	Order	Ascending	Numerical	By Destination	Absolute Time

Units

Distance Units	Speed Units	Traffic Units Input	Traffic Units Results	Flow Units	Average Delay Units	Total Delay Units	Rate Of Delay Units
m	kph	Veh	Veh	perHour	min	-Min	perMin

A2 - (Default Analysis Set) - D1 - Existing 2012, PM 1700 - 1800

Data Errors and Warnings

No errors or warnings

Analysis Set Details

Name	Description	Include In Report	Use Specific Demand Set	Demand Set	Locked	Network Flow Scaling Factor (%)	Network Capacity Scaling Factor (%)	Reason For Scaling Factors
(Default Analysis Set)		Yes		(D1)		100.000	100.000	

Demand Set Details

Name	Scenario Name	Time Period Name	Description	Locked	Run Automatically	Use Relationship	Relationship	Start Time (HH:mm)	Finish Time (HH:mm)	Time Period Length	Time Segment Length	Traffic Profile Type
------	---------------	------------------	-------------	--------	-------------------	------------------	--------------	--------------------	---------------------	--------------------	---------------------	----------------------

Existing 2012, PM 1700 - 1800	Existing 2012	PM 1700 - 1800	Peak Hour Flows		Yes			16:45	18:15	90	15	ONE HOUR
-------------------------------	---------------	----------------	-----------------	--	-----	--	--	-------	-------	----	----	----------

Roundabout Network

Roundabout Type(s)

ID	Name	Arm Order	Roundabout Type	Grade Separated	Large Roundabout	Do Geometric Delay
1	Boxted Road/The Avenue Roundabout	1,2,3,4	Standard			

Roundabout Network Options

Driving Side	Lighting	Road Surface	In London
Left	Normal/unknown	((Mini-roundabouts only))	

Arms

Arms

ID	Name	Description
1	Boxted Road North	Single Carriageway
2	Warmark Road	Single Carriageway
3	Boxted Road South	Single Carriageway
4	The Avenue	Single Carriageway

Capacity Options

Arm	Minimum Capacity (PCU/hr)	Maximum Capacity (PCU/hr)	Assume Flat Start Profile	Initial Queue (PCU)
Boxted Road North	0.00	99999.00		0.00
Warmark Road	0.00	99999.00		0.00
Boxted Road South	0.00	99999.00		0.00
The Avenue	0.00	99999.00		0.00

Standard Geometry

Arm	V - Approach road half-width (m)	E - Entry width (m)	I' - Effective flare length (m)	R - Entry radius (m)	D - Inscribed circle diameter (m)	PHI - Conflict (entry) angle (deg)	Exit Only
Boxted Road North	3.40	5.00	6.00	10.00	24.00	31.00	
Warmark Road	2.50	3.80	3.50	13.50	24.50	27.50	
Boxted Road South	3.50	4.50	9.00	20.00	24.00	19.00	
The Avenue	3.45	5.10	12.00	29.00	24.50	17.00	

Pedestrian Crossings

Arm	Crossing Type
Boxted Road North	None
Warmark Road	None
Boxted Road South	None
The Avenue	None

Arm Slope/ Intercept and Capacity

Slope and Intercept used in model

Arm	Enter Directly	Slope	Intercept (PCU/hr)	Final Slope	Final Intercept (PCU/hr)
Boxted Road North		((calculated))	((calculated))	0.548	1224.132
Warmark Road		((calculated))	((calculated))	0.498	923.541
Boxted Road South		((calculated))	((calculated))	0.599	1333.036
The Avenue		((calculated))	((calculated))	0.635	1476.488

The slope and intercept shown above include any corrections and adjustments.

Traffic Flows

Demand Set Data Options

Default Vehicle Mix	Vehicle Mix Varies Over Time	Vehicle Mix Varies Over Turn	Vehicle Mix Varies Over Entry	Vehicle Mix Source	PCU Factor for a HV (PCU)	Default Turning Proportions	Estimate from entry/exit counts	Turning Proportions Vary Over Time	Turning Proportions Vary Over Turn	Turning Proportions Vary Over Entry
	Yes	Yes	Yes	HV Percentages	2.00				Yes	Yes

Entry Flows

General Flows Data

Arm	Profile Type	Use Turning Counts	Average Demand Flow (Veh/hr)	Flow Scaling Factor (%)	PHF
Boxted Road North	ONE HOUR	Yes	456.00	100.000	N/A
Warmark Road	ONE HOUR	Yes	8.00	100.000	N/A
Boxted Road South	ONE HOUR	Yes	636.00	100.000	N/A
The Avenue	ONE HOUR	Yes	124.00	100.000	N/A

Direct/Resultant Flows

Direct Flows Data

Time Segment	Arm	Direct Demand Entry Flow (Veh/hr)	DirectDemandEntryFlowInPCU (PCU/hr)	Direct Demand Exit Flow (Veh/hr)	Direct Demand Pedestrian Flow (Ped/hr)
16:45-17:00	Boxted Road North	343.30	347.06	N/A	N/A
16:45-17:00	Warmark Road	6.02	6.02	N/A	N/A
16:45-17:00	Boxted Road South	478.81	485.52	N/A	N/A
16:45-17:00	The Avenue	93.35	94.87	N/A	N/A
17:00-17:15	Boxted Road North	409.93	434.71	N/A	N/A
17:00-17:15	Warmark Road	7.19	8.16	N/A	N/A
17:00-17:15	Boxted Road South	571.75	665.48	N/A	N/A
17:00-17:15	The Avenue	111.47	121.40	N/A	N/A
17:15-17:30	Boxted Road North	502.07	532.41	N/A	N/A
17:15-17:30	Warmark Road	8.81	9.99	N/A	N/A
17:15-17:30	Boxted Road South	700.25	815.04	N/A	N/A
17:15-17:30	The Avenue	136.53	148.68	N/A	N/A
17:30-17:45	Boxted Road North	502.07	532.41	N/A	N/A
17:30-17:45	Warmark Road	8.81	9.99	N/A	N/A
17:30-17:45	Boxted Road South	700.25	815.04	N/A	N/A
17:30-17:45	The Avenue	136.53	148.68	N/A	N/A
17:45-18:00	Boxted Road North	409.93	431.69	N/A	N/A
17:45-18:00	Warmark Road	7.19	7.55	N/A	N/A
17:45-18:00	Boxted Road South	571.75	600.29	N/A	N/A
17:45-18:00	The Avenue	111.47	117.05	N/A	N/A
18:00-18:15	Boxted Road North	343.30	361.52	N/A	N/A
18:00-18:15	Warmark Road	6.02	6.32	N/A	N/A
18:00-18:15	Boxted Road South	478.81	502.72	N/A	N/A
18:00-18:15	The Avenue	93.35	98.02	N/A	N/A

Turning Proportions

Turning Counts or Proportions (Veh/hr) - Roundabout 1 (for whole period)

		To			
		1	2	3	4
1	2.00	3.00	416.00	35.00	

	2	2.00	0.00	6.00	0.00
From	3	417.00	3.00	1.00	215.00
	4	23.00	0.00	101.00	0.00

Turning Proportions (Veh) - Roundabout 1 (for whole period)

		To			
		1	2	3	4
From	1	0.00	0.01	0.91	0.08
	2	0.25	0.00	0.75	0.00
	3	0.66	0.00	0.00	0.34
	4	0.19	0.00	0.81	0.00

Vehicle Mix

Average PCU Per Vehicle - Roundabout 1 - (16:45-17:00)

		To			
		1	2	3	4
From	1	1.00	1.00	1.01	1.00
	2	1.00	1.00	1.00	1.00
	3	1.02	1.00	1.00	1.00
	4	1.00	1.00	1.02	1.00

Heavy Vehicle Percentages - Roundabout 1 - (16:45-17:00)

		To			
		1	2	3	4
From	1	0.00	0.00	1.20	0.00
	2	0.00	0.00	0.00	0.00
	3	1.90	0.00	0.00	0.46
	4	0.00	0.00	2.00	0.00

Average PCU Per Vehicle - Roundabout 1 - (17:00-17:15)

		To			
		1	2	3	4
From	1	1.00	1.00	1.06	1.04
	2	1.09	1.00	1.15	1.03
	3	1.15	1.00	1.00	1.19
	4	1.08	1.00	1.09	1.00

Heavy Vehicle Percentages - Roundabout 1 - (17:00-17:15)

		To			
		1	2	3	4
From	1	0.00	0.00	6.25	4.45
	2	8.85	0.00	15.00	2.50
	3	15.00	0.00	0.00	19.40
	4	7.69	0.00	9.18	0.00

Average PCU Per Vehicle - Roundabout 1 - (17:15-17:30)

		To			
		1	2	3	4
From	1	1.00	1.00	1.06	1.04
	2	1.09	1.00	1.15	1.03
	3	1.15	1.00	1.00	1.19
	4	1.08	1.00	1.09	1.00

Heavy Vehicle Percentages - Roundabout 1 - (17:15-17:30)

		To			
		1	2	3	4
	1	0.00	0.00	6.25	4.45

	2	8.85	0.00	15.00	2.50
From	3	15.00	0.00	0.00	19.40
	4	7.69	0.00	9.18	0.00

Average PCU Per Vehicle - Roundabout 1 - (17:30-17:45)

		To			
		1	2	3	4
From	1	1.00	1.00	1.06	1.04
	2	1.09	1.00	1.15	1.03
	3	1.15	1.00	1.00	1.19
	4	1.08	1.00	1.09	1.00

Heavy Vehicle Percentages - Roundabout 1 - (17:30-17:45)

		To			
		1	2	3	4
From	1	0.00	0.00	6.25	4.45
	2	8.85	0.00	15.00	2.50
	3	15.00	0.00	0.00	19.40
	4	7.69	0.00	9.18	0.00

Average PCU Per Vehicle - Roundabout 1 - (17:45-18:00)

		To			
		1	2	3	4
From	1	1.00	1.55	1.05	1.05
	2	1.05	1.00	1.05	1.05
	3	1.05	1.05	1.00	1.05
	4	1.05	1.05	1.05	1.00

Heavy Vehicle Percentages - Roundabout 1 - (17:45-18:00)

		To			
		1	2	3	4
From	1	0.00	55.00	5.00	5.00
	2	5.00	0.00	5.00	5.00
	3	5.00	5.00	0.00	5.00
	4	5.00	5.00	5.00	0.00

Average PCU Per Vehicle - Roundabout 1 - (18:00-18:15)

		To			
		1	2	3	4
From	1	1.00	1.55	1.05	1.05
	2	1.05	1.00	1.05	1.05
	3	1.05	1.05	1.00	1.05
	4	1.05	1.05	1.05	1.00

Heavy Vehicle Percentages - Roundabout 1 - (18:00-18:15)

		To			
		1	2	3	4
From	1	0.00	55.00	5.00	5.00
	2	5.00	0.00	5.00	5.00
	3	5.00	5.00	0.00	5.00
	4	5.00	5.00	5.00	0.00

Results

Results Summary

Arm	Max RFC	Max Delay (min)	Max Queue (Veh)	Max LOS	Total Demand (Veh/hr)	Total Arrivals (Veh)	Total Queueing Delay (Veh-min)	Average Queueing Delay (min)	Rate Of Queueing Delay (Veh-	Inclusive Queueing Total Delay	Inclusive Queueing Average Delay	Slope	Intercept (PCU/hr)
-----	---------	-----------------	-----------------	---------	-----------------------	----------------------	--------------------------------	------------------------------	------------------------------	--------------------------------	----------------------------------	-------	--------------------

									min/min)	(Veh-min)	(min)		
Boxted Road North	0.46	0.10	0.86	A	418.34	627.51	55.63	0.09	0.62	55.63	0.09	0.548	1224.132
Warmark Road	0.02	0.12	0.02	A	7.32	10.99	1.13	0.10	0.01	1.13	0.10	0.498	923.541
Boxted Road South	0.62	0.14	1.71	A	581.66	872.49	94.46	0.11	1.05	94.46	0.11	0.599	1333.036
The Avenue	0.13	0.07	0.15	A	113.71	170.57	10.23	0.06	0.11	10.23	0.06	0.635	1476.488

Main Results

Main results: (16:45-17:00)

Arm	Demand (Veh/hr)	Arrivals (Veh)	Entry Flow (Veh/hr)	Exit Flow (Veh/hr)	Circulating Flow (Veh/hr)	Pedestrian Demand (Ped/hr)	Capacity (Veh/hr)	Saturation Capacity (Veh/hr)	RFC	Start Queue (Veh)	End Queue (Veh)
Boxted Road North	343.30	85.82	341.64	332.67	78.77	0.00	1167.34	801.77	0.294	0.00	0.41
Warmark Road	6.02	1.51	5.99	4.50	415.92	0.00	713.94	150.22	0.008	0.00	0.01
Boxted Road South	478.82	119.70	476.49	392.70	29.22	0.00	1297.36	1254.02	0.369	0.00	0.58
The Avenue	93.35	23.34	93.03	187.30	318.41	0.00	1250.16	898.72	0.075	0.00	0.08

Main results: (17:00-17:15)

Arm	Demand (Veh/hr)	Arrivals (Veh)	Entry Flow (Veh/hr)	Exit Flow (Veh/hr)	Circulating Flow (Veh/hr)	Pedestrian Demand (Ped/hr)	Capacity (Veh/hr)	Saturation Capacity (Veh/hr)	RFC	Start Queue (Veh)	End Queue (Veh)
Boxted Road North	410.01	102.50	409.24	397.95	94.28	0.00	1101.55	761.10	0.372	0.39	0.59
Warmark Road	7.20	1.80	7.18	5.38	498.13	0.00	581.30	130.71	0.012	0.01	0.01
Boxted Road South	572.01	143.00	569.97	470.31	35.00	0.00	1127.00	1094.39	0.508	0.51	1.02
The Avenue	111.49	27.87	111.35	224.09	380.88	0.00	1101.20	848.29	0.101	0.08	0.11

Main results: (17:15-17:30)

Arm	Demand (Veh/hr)	Arrivals (Veh)	Entry Flow (Veh/hr)	Exit Flow (Veh/hr)	Circulating Flow (Veh/hr)	Pedestrian Demand (Ped/hr)	Capacity (Veh/hr)	Saturation Capacity (Veh/hr)	RFC	Start Queue (Veh)	End Queue (Veh)
Boxted Road North	502.07	125.52	501.04	487.23	115.47	0.00	1089.42	760.96	0.461	0.59	0.84
Warmark Road	8.81	2.20	8.79	6.59	609.92	0.00	528.69	130.65	0.017	0.01	0.02
Boxted Road South	700.25	175.06	697.83	575.86	42.85	0.00	1122.26	1093.89	0.624	1.02	1.62
The Avenue	136.53	34.13	136.38	274.36	466.32	0.00	1043.72	848.14	0.131	0.11	0.15

Main results: (17:30-17:45)

Arm	Demand (Veh/hr)	Arrivals (Veh)	Entry Flow (Veh/hr)	Exit Flow (Veh/hr)	Circulating Flow (Veh/hr)	Pedestrian Demand (Ped/hr)	Capacity (Veh/hr)	Saturation Capacity (Veh/hr)	RFC	Start Queue (Veh)	End Queue (Veh)
Boxted Road North	502.07	125.52	502.05	488.80	115.61	0.00	1089.34	760.96	0.461	0.84	0.85
Warmark Road	8.81	2.20	8.81	6.61	611.04	0.00	528.16	130.65	0.017	0.02	0.02
Boxted Road South	700.25	175.06	700.17	576.91	42.94	0.00	1122.21	1093.89	0.624	1.62	1.64
The Avenue	136.53	34.13	136.52	275.23	467.88	0.00	1042.68	848.14	0.131	0.15	0.15

Main results: (17:45-18:00)

Arm	Demand (Veh/hr)	Arrivals (Veh)	Entry Flow (Veh/hr)	Exit Flow (Veh/hr)	Circulating Flow (Veh/hr)	Pedestrian Demand (Ped/hr)	Capacity (Veh/hr)	Saturation Capacity (Veh/hr)	RFC	Start Queue (Veh)	End Queue (Veh)
Boxted Road North	409.91	102.48	410.97	401.21	94.55	0.00	1110.72	769.96	0.369	0.86	0.59
Warmark Road	7.19	1.80	7.21	5.42	500.11	0.00	630.20	144.34	0.011	0.02	0.01
Boxted Road South	570.97	142.74	574.82	472.18	35.15	0.00	1246.96	1209.06	0.458	1.81	0.85
The Avenue	111.45	27.86	111.65	225.85	384.11	0.00	1161.81	872.16	0.096	0.16	0.11

Main results: (18:00-18:15)

Arm	Demand (Veh/hr)	Arrivals (Veh)	Entry Flow (Veh/hr)	Exit Flow (Veh/hr)	Circulating Flow (Veh/hr)	Pedestrian Demand (Ped/hr)	Capacity (Veh/hr)	Saturation Capacity (Veh/hr)	RFC	Start Queue (Veh)	End Queue (Veh)
Boxted Road North	343.30	85.83	343.88	334.89	79.13	0.00	1119.22	770.01	0.307	0.59	0.45
Warmark Road	6.02	1.51	6.03	4.53	418.48	0.00	671.36	144.46	0.009	0.01	0.01
Boxted Road South	478.81	119.70	479.74	395.10	29.41	0.00	1252.08	1210.71	0.382	0.85	0.62
The Avenue	93.35	23.34	93.44	188.57	320.58	0.00	1202.67	872.34	0.078	0.11	0.08

Queueing Delay Results

Queueing Delay results: (16:45-17:00)

Arm	Queueing Total Delay (Veh-min)	Queueing Rate Of Delay (Veh-min/min)	Average Delay Per Arriving Vehicle (min)	Unsignalised Level Of Service	Signalised Level Of Service
Boxted Road North	6.04	0.40	0.073	A	A
Warmark Road	0.12	0.01	0.085	A	A
Boxted Road South	8.46	0.56	0.073	A	A
The Avenue	1.19	0.08	0.052	A	A

Queueing Delay results: (17:00-17:15)

Arm	Queueing Total Delay (Veh-min)	Queueing Rate Of Delay (Veh-min/min)	Average Delay Per Arriving Vehicle (min)	Unsignalised Level Of Service	Signalised Level Of Service
Boxted Road North	8.60	0.57	0.087	A	A
Warmark Road	0.18	0.01	0.105	A	A
Boxted Road South	14.66	0.98	0.107	A	A
The Avenue	1.66	0.11	0.061	A	A

Queueing Delay results: (17:15-17:30)

Arm	Queueing Total Delay (Veh-min)	Queueing Rate Of Delay (Veh-min/min)	Average Delay Per Arriving Vehicle (min)	Unsignalised Level Of Service	Signalised Level Of Service
Boxted Road North	12.30	0.82	0.102	A	A
Warmark Road	0.25	0.02	0.115	A	A
Boxted Road South	23.16	1.54	0.141	A	A
The Avenue	2.21	0.15	0.066	A	A

Queueing Delay results: (17:30-17:45)

Arm	Queueing Total Delay (Veh-min)	Queueing Rate Of Delay (Veh-min/min)	Average Delay Per Arriving Vehicle (min)	Unsignalised Level Of Service	Signalised Level Of Service
Boxted Road North	12.71	0.85	0.102	A	A
Warmark Road	0.25	0.02	0.116	A	A
Boxted Road South	24.48	1.63	0.142	A	A
The Avenue	2.25	0.15	0.066	A	A

Queueing Delay results: (17:45-18:00)

Arm	Queueing Total Delay (Veh-min)	Queueing Rate Of Delay (Veh-min/min)	Average Delay Per Arriving Vehicle (min)	Unsignalised Level Of Service	Signalised Level Of Service
Boxted Road North	9.08	0.61	0.086	A	A
Warmark Road	0.18	0.01	0.096	A	A
Boxted Road South	13.29	0.89	0.090	A	A
The Avenue	1.62	0.11	0.057	A	A

Queueing Delay results: (18:00-18:15)

Arm	Queueing Total Delay (Veh-min)	Queueing Rate Of Delay (Veh-min/min)	Average Delay Per Arriving Vehicle (min)	Unsignalised Level Of Service	Signalised Level Of Service
Boxted Road North	6.82	0.45	0.077	A	A
Warmark Road	0.14	0.01	0.090	A	A
Boxted Road South	9.58	0.64	0.078	A	A
The Avenue	1.28	0.09	0.054	A	A

Overview: Standard Roundabout Geometry

Standard Geometry

Arm	V - Approach road half-width (m)	E - Entry width (m)	I' - Effective flare length (m)	R - Entry radius (m)	D - Inscribed circle diameter (m)	PHI - Conflict (entry) angle (deg)	Exit Only	Final Slope	Final Intercept (PCU/hr)
Boxted Road North	3.40	5.00	6.00	10.00	24.00	31.00		0.548	1224.132
Warmark Road	2.50	3.80	3.50	13.50	24.50	27.50		0.498	923.541
Boxted Road South	3.50	4.50	9.00	20.00	24.00	19.00		0.599	1333.036
The Avenue	3.45	5.10	12.00	29.00	24.50	17.00		0.635	1476.488

Overview: Time Segment Results

Time Segment Results

Time Segment	Arm	Demand (Veh/hr)	Capacity (Veh/hr)	RFC	Pedestrian Demand (Ped/hr)	Start Queue (Veh)	End Queue (Veh)	Queueing Total Delay (Veh-min)	Geometric Total Delay (Veh-min)	Average Delay Per Arriving Vehicle (min)
16:45-17:00	Boxted Road North	343.30	1167.34	0.294	0.00	0.00	0.41	6.04	(16.28)	0.073
16:45-17:00	Warmark Road	6.02	713.94	0.008	0.00	0.00	0.01	0.12	(22.65)	0.085
16:45-17:00	Boxted Road South	478.82	1297.36	0.369	0.00	0.00	0.58	8.46	(18.58)	0.073
16:45-17:00	The Avenue	93.35	1250.16	0.075	0.00	0.00	0.08	1.19	(16.33)	0.052
17:00-17:15	Boxted Road North	410.01	1101.55	0.372	0.00	0.39	0.59	8.60	(15.52)	0.087
17:00-17:15	Warmark Road	7.20	581.30	0.012	0.00	0.01	0.01	0.18	(19.98)	0.105
17:00-17:15	Boxted Road South	572.01	1127.00	0.508	0.00	0.51	1.02	14.66	(16.20)	0.107
17:00-17:15	The Avenue	111.49	1101.20	0.101	0.00	0.08	0.11	1.66	(15.24)	0.061
17:15-17:30	Boxted Road North	502.07	1089.42	0.461	0.00	0.59	0.84	12.30	(15.52)	0.102
17:15-17:30	Warmark Road	8.81	528.69	0.017	0.00	0.01	0.02	0.25	(19.97)	0.115
17:15-17:30	Boxted Road South	700.25	1122.26	0.624	0.00	1.02	1.62	23.16	(16.19)	0.141
17:15-17:30	The Avenue	136.53	1043.72	0.131	0.00	0.11	0.15	2.21	(15.24)	0.066
17:30-17:45	Boxted Road North	502.07	1089.34	0.461	0.00	0.84	0.85	12.71	(15.52)	0.102
17:30-17:45	Warmark Road	8.81	528.16	0.017	0.00	0.02	0.02	0.25	(19.97)	0.116
17:30-17:45	Boxted Road South	700.25	1122.21	0.624	0.00	1.62	1.64	24.48	(16.19)	0.142
17:30-17:45	The Avenue	136.53	1042.68	0.131	0.00	0.15	0.15	2.25	(15.24)	0.066
17:45-18:00	Boxted Road North	409.91	1110.72	0.369	0.00	0.86	0.59	9.08	(15.63)	0.086
17:45-18:00	Warmark Road	7.19	630.20	0.011	0.00	0.02	0.01	0.18	(21.56)	0.096
17:45-18:00	Boxted Road South	570.97	1246.96	0.458	0.00	1.81	0.85	13.29	(17.92)	0.090
17:45-18:00	The Avenue	111.45	1161.81	0.096	0.00	0.16	0.11	1.62	(15.80)	0.057
18:00-18:15	Boxted Road North	343.30	1119.22	0.307	0.00	0.59	0.45	6.82	(15.63)	0.077
18:00-18:15	Warmark Road	6.02	671.36	0.009	0.00	0.01	0.01	0.14	(21.58)	0.090
18:00-18:15	Boxted Road South	478.81	1252.08	0.382	0.00	0.85	0.62	9.58	(17.95)	0.078
18:00-18:15	The Avenue	93.35	1202.67	0.078	0.00	0.11	0.08	1.28	(15.81)	0.054



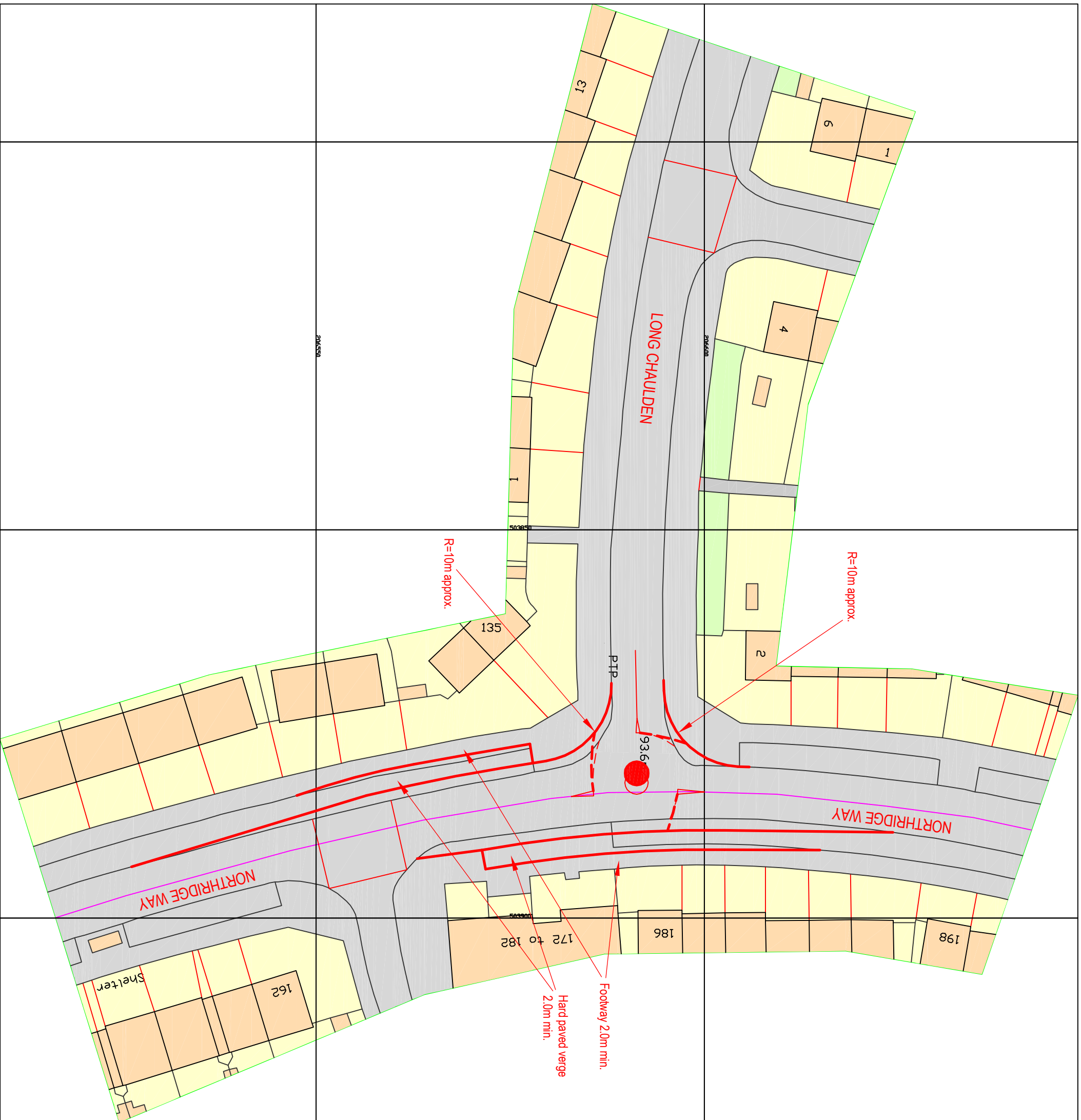

LEGEND

Proposed Improvements

Rev	Description	Date	Drawn	Checked

stomor
CIVIL ENGINEERING CONSULTANTS

Registered Office:
32 Beehive Lane, Walsby, Gledham, Cym.
Northampton, NN4 7AP

Design Office:
49 Marlborough Road, Filton, Bristol, BS41 4SP
Tel: 01454 614543
Email: info@stomor.com www.stomor.com

Project
Land at Fields End, Hemel Hempstead

Drawing Description
Roundabout Junction of Long Chaulden and Northridge Way.
Existing Layout and Proposed Improvements.

Scale	Date	Drawn By	Checked By
1:500	11/05/12	LAF	DGS
Client	Architect		

Notes
Do not scale of the drawing.
Only written dimensions should be taken.
Any discrepancies or errors should be brought to the attention of the signifier immediately.

Drawing Number
ST-2189-25



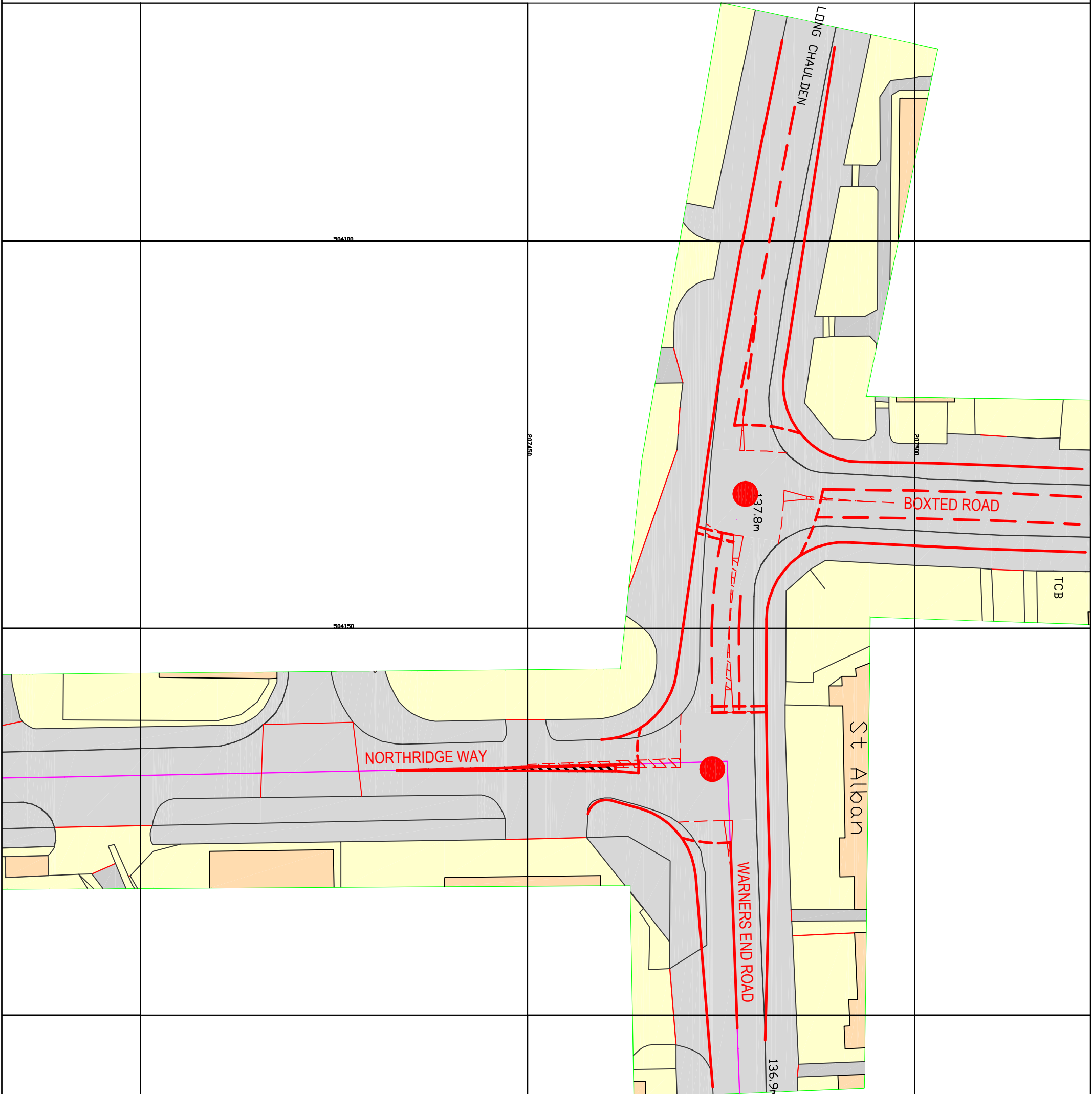

LEGEND

Proposed Improvements

Rev	Description	Date	Drawn	Checked

stomor
CIVIL ENGINEERING CONSULTANTS

Registered Office:
32 Bevine Lane, Watlyn Garden, City,
Northbridge, ACT 2602

Design Office:
49 Melbourne Road, Fyshwick, Victoria 3041, Australia
Tel: 03 9462 6142
Email: info@stomor.com www.stomor.com

Project
Land at Fields End, Hemel Hempstead

Drawing Description
Roundabout Junctions Between Long Chaulden, Boxted Road and Northridge Way.
Existing Layout and Proposed Improvements.

Scale	Date	Drawn By	Checked By
1:500	11/05/12	LAF	DGS
Client		Architect	

Notes
Do not scale of the drawing.
Only written dimensions should be taken.
Any discrepancies or errors should be brought to the attention of the engineer immediately.

Drawing Number: **ST-2189-26**

504100

504150

207450

207450

**WARNERS END ROAD / BO TED ROAD /
NORTHRIDGE
HEMEL HEMPSTEAD
CAPACITY REPORT**

Traffic Signal Design Ltd Report No 001 T120502 OC 001

20th May 2012

Prepared for:

STOMOR Ltd

FAO: Duncan Stoten

Prepared by:

Traffic Signal Design Ltd

50 Constance Avenue, Lincoln, LN6 8SN

T: 01522 688707

E: bc@trafficsignaldesign.com

Basic Summary of Findings

Traffic Signal Design Ltd has been commissioned by STOMOR Ltd to investigate the option of introducing traffic signal controller to the junctions of Boxted Road / Long Chaulden & Warners End Road / Northgate. Currently the junctions operated as priority controlled mini roundabouts. The two junctions are approximately 30 meters apart and form two separate three arm junctions.

A traffic model of the existing junctions was produced this was based on current layout and lane availability. It was found that the junction would be seriously over capacity in this form.

A basic proposed layout was investigated that would require the provision of providing additional carriageway width and lanes at the two junctions and the link between them.

A revised LINSIG model was produced based of the proposal and the junction is detailed as working well within capacity – The proposal would be subject to detailed investigation as there are several unknowns at this time.

It should be noted that no provision has been provided for pedestrians within this model.

Detailed below are the associated findings of the LINSIG model based on the proposed layout.

Calculated	AM Peak (Cycle Time 0 Seconds)		PM Peak (Cycle Time 82 Seconds)	
	Deg Sat	MMQ	Deg Sat	MMQ
Warners End Road	50.6%	7.8	63.8%	6.1
Northridge	75.5%	7.0	62.9%	6.3
Long Chaulden	17.0%	1.7	40.9%	3.6
Boxted Road	53.4%	8.3	57.0%	8.6
	PRC		PRC	
	19.2%		36.5	

Fig 1

Please find the detailed LINSIG results below:

User and Project Details

Project:	Proposed Signalisation
Title:	Revised Layout to Existing Junctions
Location:	Warners End Rd / Northgate / Long Chaulden / Boxed Rd: Hemel Hempstead
File name:	Stomor Warners End 19-05-12 BC Changes.lsg3x
Author:	Barry Cheshire
Company:	Traffic Signal Design Ltd
Address:	50 Constance Avenue Lincoln LN6 8SN (bc@trafficsignaldesign.com)
Notes:	Subject to detailed investigation of proposed layout

Network Layout Diagram

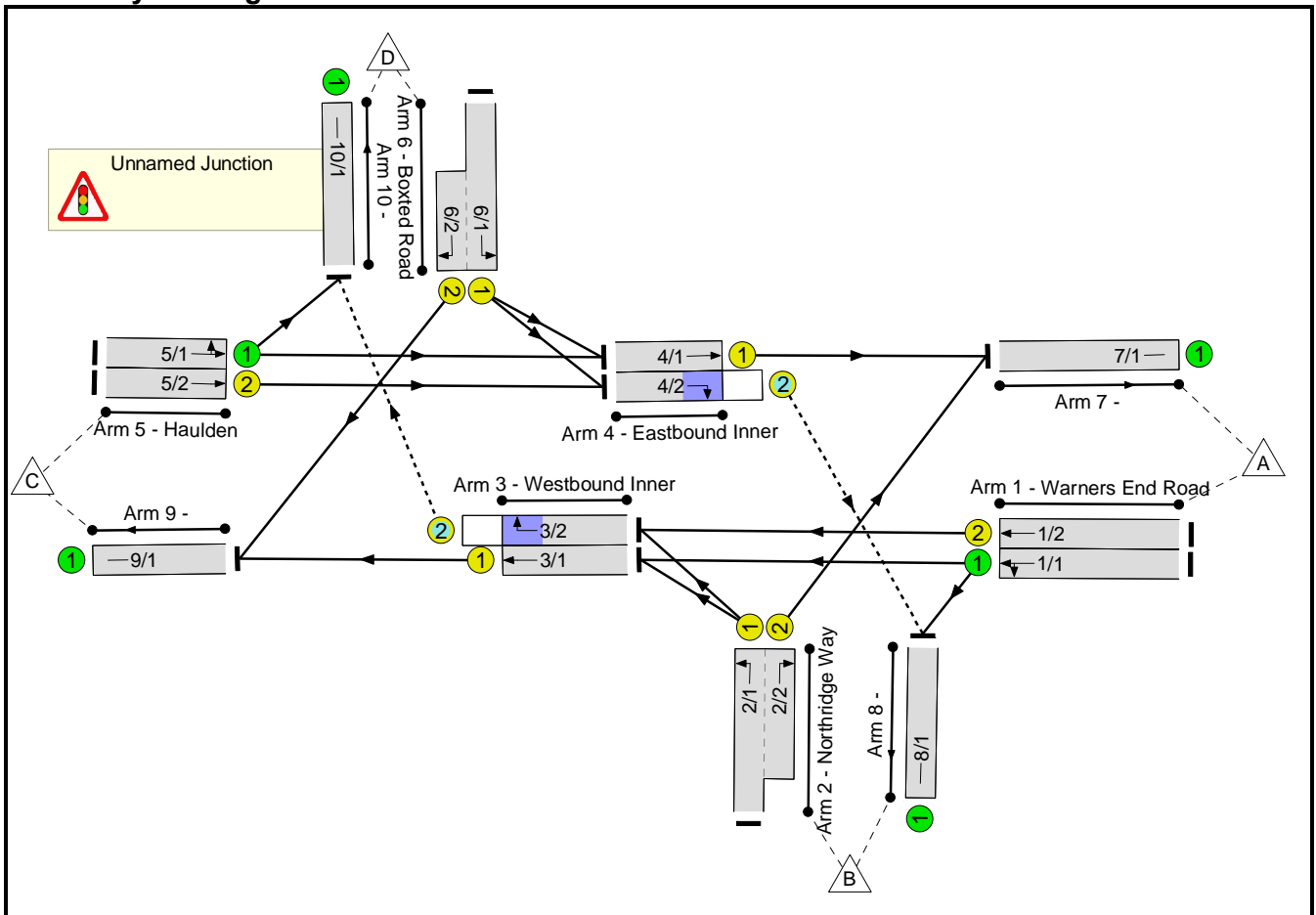

Phase Diagram

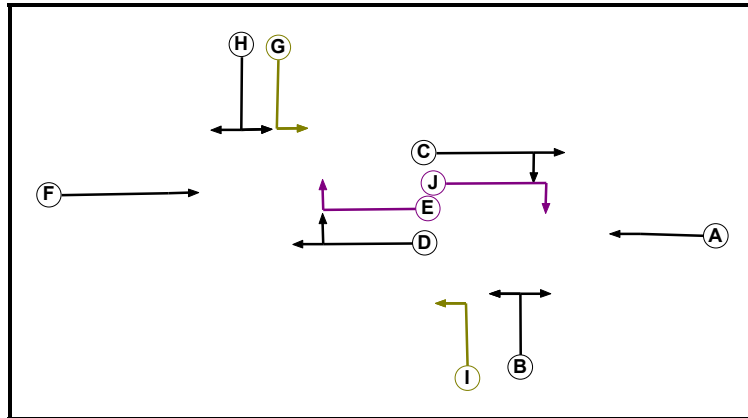

Phase Input Data

Phase Name	Phase Type	Assoc Phase	Street Min	Cont Min
A	Traffic		7	7
B	Traffic		7	7
C	Traffic		7	7
D	Traffic		7	7
E	Ind. Arrow	D	4	4
F	Traffic		7	7
G	Filter	H	4	0
H	Traffic		7	7
I	Filter	B	4	0
J	Ind. Arrow	C	4	4

Phase Intergreens Matrix

		Starting Phase									
		A	B	C	D	E	F	G	H	I	J
Terminating Phase	A	5	-	-	-	-	-	-	-	-	-
	B	5	5	-	-	-	-	-	-	-	-
	C	-	5	-	-	-	-	-	-	-	-
	D	-	-	-	-	-	-	-	5	-	-
	E	-	-	-	-	5	5	5	-	-	-
	F	-	-	-	-	5	5	5	-	-	-
	G	-	-	-	-	5	5	5	-	-	-
	H	-	-	-	5	5	5	5	-	-	-
	I	-	-	-	-	-	-	-	-	-	-
	J	-	-	-	-	-	-	-	-	-	-

Phases in Stage

Stage No	Phases in Stage
1	A C D F
2	C D E G I J
3	B H
4	

Stage Diagram

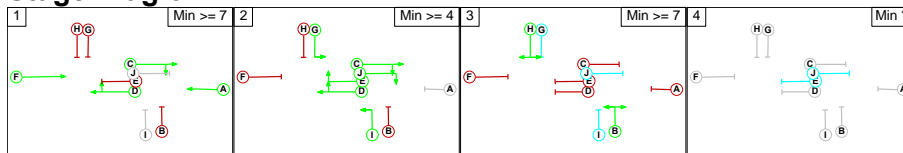

Phase Delays

Term	Stage	Start Stage	Phase	Type	Value	Cont value
There are no Phase Delays defined						

Prohibited Stage Change

		To Stage			
		1	2	3	4
From Stage	1	5	5	X	
	2	X	5	X	
	3	5	X	X	
	4	X	X	X	

Give-Way Lane Input Data

Junction: Unnamed Junction										
Lane	Movement	Max Flow when Giving Way (PCU/Hr)	Opposing Lane	Opp Lane Coeff	Opp Mvmnts	Right Turn Storage (PCU)	Non-Blocking Storage (PCU)	RTF	Right Turn Move up (s)	Max Turns in Intergreen (PCU)
3/2 (Westbound Inner)	10/1 (Right)	1439	5/1	1.09	5/1	2.00	-	0.50	2	2.00
			5/2	1.09	5/2					
4/2 (Eastbound Inner)	8/1 (Right)	1439	1/1	1.09	1/1	2.00	-	0.50	2	2.00
			1/2	1.09	1/2					

Lane Input Data

Junction: Unnamed Junction												
Lane	Lane Type	Phases	Start Disp	End Disp	Physical Length (PCU)	Sat Flow Type	Def User Saturation Flow (PCU/Hr)	Lane Width (m)	Gradient	Nearside Lane	Turns	Turning Radius (m)
1/1 (Warners End Road)	U		2	3	60.0	Geom	-	3.20	0.00	Y	Arm 3 Ahead	Inf
1/2 (Warners End Road)	U	A	2	3	60.0	Geom	-	3.20	0.00	Y	Arm 8 Left	Inf
2/1 (Northridge Way)	U	B I	2	3	60.0	Geom	-	3.20	0.00	Y	Arm 3 Ahead	Inf
2/2 (Northridge Way)	U	B	2	3	10.0	Geom	-	3.20	0.00	Y	Arm 3 Left	Inf
3/1 (Westbound Inner)	U	D	2	3	4.3	Geom	-	2.97	0.00	Y	Arm 7 Right	Inf
3/2 (Westbound Inner)	O	D E	2	3	4.3	Geom	-	2.97	0.00	Y	Arm 9 Ahead	Inf
4/1 (Eastbound Inner)	U	C	2	3	4.3	Geom	-	2.90	0.00	Y	Arm 10 Right	Inf
4/2 (Eastbound Inner)	O	C J	2	3	4.3	Geom	-	2.97	0.00	Y	Arm 7 Ahead	Inf
5/1 (Haulden)	U		2	3	60.0	Geom	-	3.20	0.00	Y	Arm 8 Right	Inf
5/2 (Haulden)	U	F	2	3	60.0	Geom	-	3.20	0.00	Y	Arm 4 Ahead	Inf
6/1 (Boxted Road)	U	H G	2	3	60.0	Geom	-	3.20	0.00	Y	Arm 10 Left	Inf
6/2 (Boxted Road)	U	H	2	3	5.0	Geom	-	3.20	0.00	Y	Arm 4 Left	Inf
7/1	U		2	3	60.0	Inf	-	-	-	-	Arm 9 Right	Inf
8/1	U		2	3	60.0	Inf	-	-	-	-	-	-
9/1	U		2	3	60.0	Inf	-	-	-	-	-	-
10/1	U		2	3	60.0	Inf	-	-	-	-	-	-

Traffic Flow Groups

Flow Group	Start Time	End Time	Duration	Formula
1: 'AM'	08:00	09:00	01:00	
2: 'PM'	17:00	18:00	01:00	

Scenario 1: 'Scenario 1' (FG1: 'AM', Plan 1: 'Network Control Plan 1')

Traffic Flows, Desired

Desired Flow :

		Destination				
		A	B	C	D	Tot.
Origin	A	0	194	202	256	652
	B	267	0	121	153	541
	C	365	164	0	82	611
	D	470	231	85	0	786
	Tot.	1102	589	408	491	2590

Traffic Lane Flows

Lane	Scenario 1: Scenario 1
Junction: Unnamed Junction	
1/1	396
1/2	256
2/1 (with short)	541(In) 274(Out)
2/2 (short)	267
3/1	323
3/2	409
4/1	835
4/2	395
5/1	447
5/2	164
6/1 (with short)	786(In) 701(Out)
6/2 (short)	85
7/1	1102
8/1	589
9/1	408
10/1	491

Lane Saturation Flows

Junction: Unnamed Junction								
Lane	Lane Width (m)	Gradient	Nearside Lane	Allowed Turns	Turning Radius (m)	Turning Prop	Sat Flow (PCU/Hr)	Flared Sat Flow (PCU/Hr)
1/1 (Warners End Road)	3.20	0.00	Y	Arm 3 Ahead	Inf	51.0 %	1935	1935
				Arm 8 Left	Inf	49.0 %		
1/2 (Warners End Road)	3.20	0.00	Y	Arm 3 Ahead	Inf	100.0 %	1935	1935
2/1 (Northridge Way)	3.20	0.00	Y	Arm 3 Left	Inf	100.0 %	1935	1935
2/2 (Northridge Way)	3.20	0.00	Y	Arm 7 Right	Inf	100.0 %	1935	1935
3/1 (Westbound Inner)	2.97	0.00	Y	Arm 9 Ahead	Inf	100.0 %	1912	1912
3/2 (Westbound Inner)	2.97	0.00	Y	Arm 10 Right	Inf	100.0 %	1912	1912
4/1 (Eastbound Inner)	2.90	0.00	Y	Arm 7 Ahead	Inf	100.0 %	1905	1905
4/2 (Eastbound Inner)	2.97	0.00	Y	Arm 8 Right	Inf	100.0 %	1912	1912
5/1 (Haulden)	3.20	0.00	Y	Arm 4 Ahead	Inf	81.7 %	1935	1935
				Arm 10 Left	Inf	18.3 %		
5/2 (Haulden)	3.20	0.00	Y	Arm 4 Ahead	Inf	100.0 %	1935	1935
6/1 (Boxted Road)	3.20	0.00	Y	Arm 4 Left	Inf	100.0 %	1935	1935
6/2 (Boxted Road)	3.20	0.00	Y	Arm 9 Right	Inf	100.0 %	1935	1935
7/1	Infinite Saturation Flow						Inf	Inf
8/1	Infinite Saturation Flow						Inf	Inf
9/1	Infinite Saturation Flow						Inf	Inf
10/1	Infinite Saturation Flow						Inf	Inf

Scenario 2: 'New Scenario' (FG2: 'PM', Plan 1: 'Network Control Plan 1')

Traffic Flows, Desired

Desired Flow :

	Destination					
	A	B	C	D	Tot.	
Origin	A	0	271	348	392	1011
B	211	0	191	215	617	
C	206	102	0	123	431	
D	298	147	112	0	557	
Tot.	715	520	651	730	2616	

Traffic Lane Flows

Lane	Scenario 2: New Scenario
Junction: Unnamed Junction	
1/1	619
1/2	392
2/1 (with short)	617(In) 406(Out)
2/2 (short)	211
3/1	539
3/2	607
4/1	504
4/2	249
5/1	329
5/2	102
6/1 (with short)	557(In) 445(Out)
6/2 (short)	112
7/1	715
8/1	520
9/1	651
10/1	730

Lane Saturation Flows

Junction: Unnamed Junction								
Lane	Lane Width (m)	Gradient	Nearside Lane	Allowed Turns	Turning Radius (m)	Turning Prop	Sat Flow (PCU/Hr)	Flared Sat Flow (PCU/Hr)
1/1 (Warners End Road)	3.20	0.00	Y	Arm 3 Ahead	Inf	56.2 %	1935	1935
				Arm 8 Left	Inf	43.8 %		
1/2 (Warners End Road)	3.20	0.00	Y	Arm 3 Ahead	Inf	100.0 %	1935	1935
2/1 (Northridge Way)	3.20	0.00	Y	Arm 3 Left	Inf	100.0 %	1935	1935
2/2 (Northridge Way)	3.20	0.00	Y	Arm 7 Right	Inf	100.0 %	1935	1935
3/1 (Westbound Inner)	2.97	0.00	Y	Arm 9 Ahead	Inf	100.0 %	1912	1912
3/2 (Westbound Inner)	2.97	0.00	Y	Arm 10 Right	Inf	100.0 %	1912	1912
4/1 (Eastbound Inner)	2.90	0.00	Y	Arm 7 Ahead	Inf	100.0 %	1905	1905
4/2 (Eastbound Inner)	2.97	0.00	Y	Arm 8 Right	Inf	100.0 %	1912	1912
5/1 (Haulden)	3.20	0.00	Y	Arm 4 Ahead	Inf	62.6 %	1935	1935
				Arm 10 Left	Inf	37.4 %		
5/2 (Haulden)	3.20	0.00	Y	Arm 4 Ahead	Inf	100.0 %	1935	1935
6/1 (Boxted Road)	3.20	0.00	Y	Arm 4 Left	Inf	100.0 %	1935	1935
6/2 (Boxted Road)	3.20	0.00	Y	Arm 9 Right	Inf	100.0 %	1935	1935
7/1	Infinite Saturation Flow						Inf	Inf
8/1	Infinite Saturation Flow						Inf	Inf
9/1	Infinite Saturation Flow						Inf	Inf
10/1	Infinite Saturation Flow						Inf	Inf

Scenario 1: 'Scenario 1' (FG1: 'AM', Plan 1: 'Network Control Plan 1')

Stage Sequence Diagram

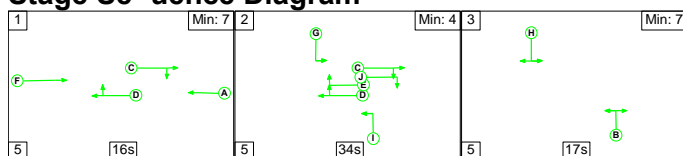

Stage Timings

Stage	1	2	3
Duration	16	34	17
Change Point	0	21	60

Signal Timings Diagram

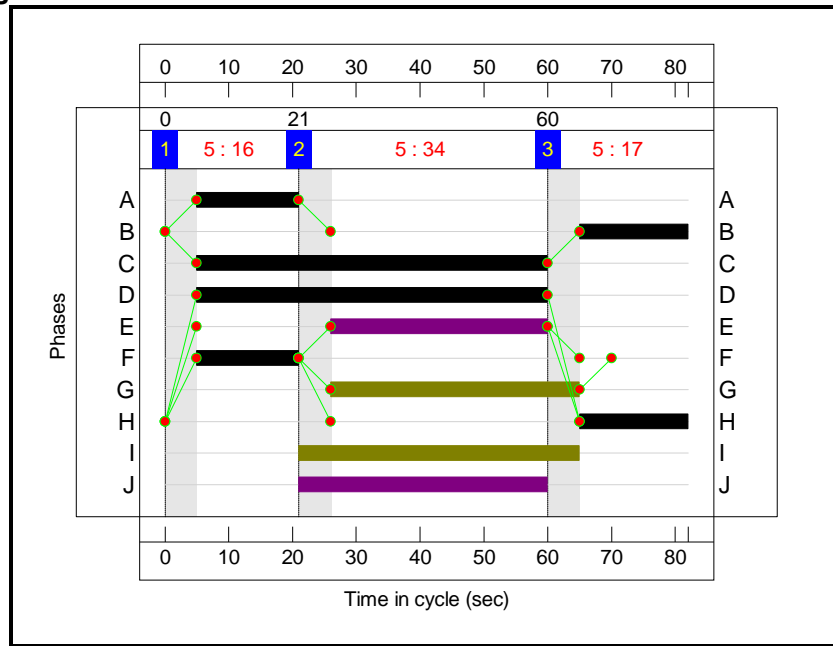

Full Input Data And Results
Network Layout Diagram

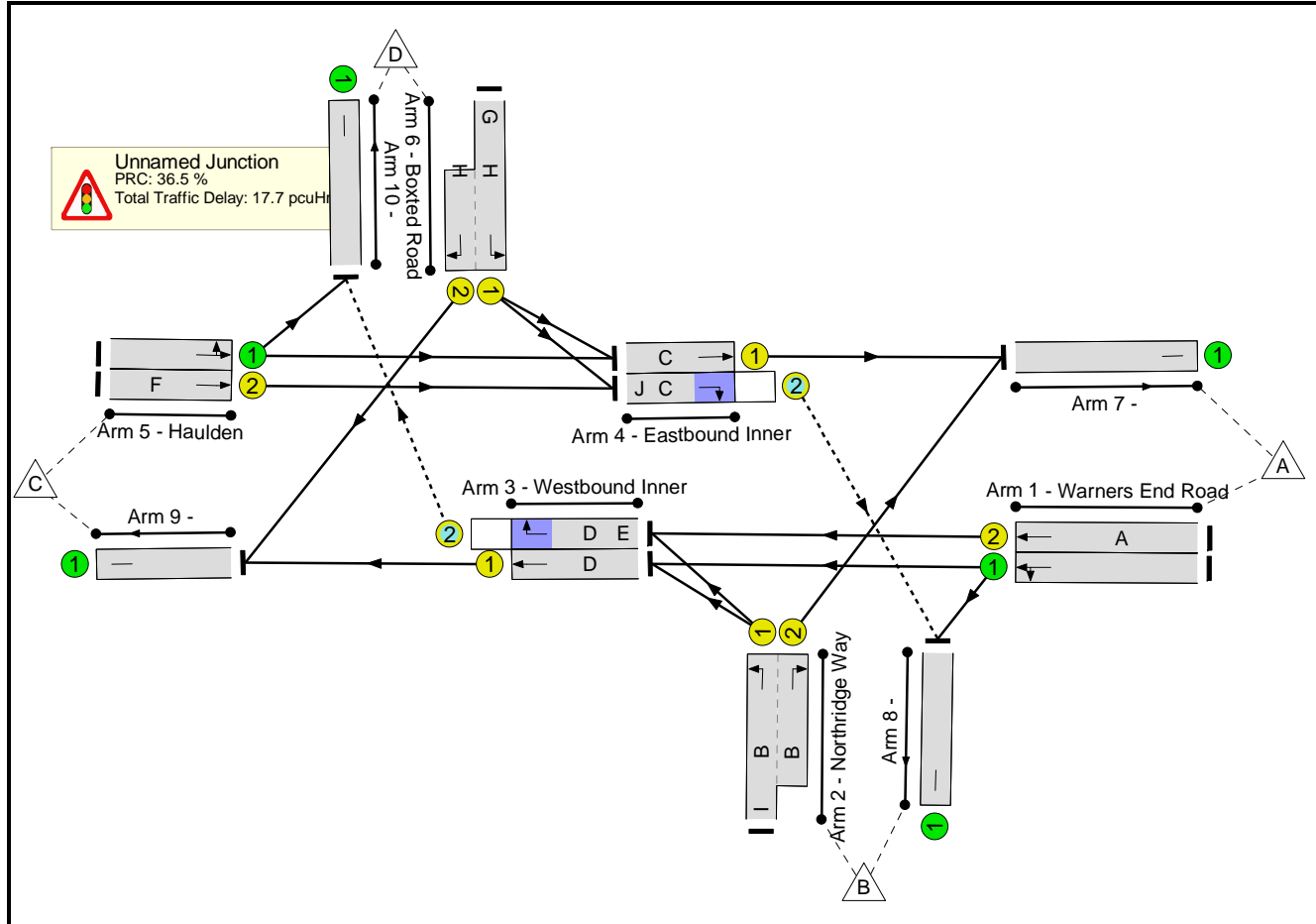

Full Input Data And Results

Network Results

Item	Lane Description	Lane Type	Controller Stream	Position In Filtered Route	Full Phase	Arrow Phase	Num Greens	Total Green (s)	Arrow Green (s)	Demand Flow (pcu)	Sat Flow (pcu/Hr)	Capacity (pcu)	Deg Sat (%)
Network	-	-	N/A	-	-		-	-	-	-	-	-	65 %
Unnamed Junction	-	-	N/A	-	-		-	-	-	-	-	-	65 %
1/1	Warners End Road Ahead Left	U	N/A	N/A	-		-	-	-	396	1935	1935	20.5%
1/2	Warners End Road Ahead	U	N/A	N/A	A		1	16	-	256	1935	401	63.8%
2/1+2/2	Northridge Way Left Right	U	N/A	N/A	B	I	1	61:17	44	541	1935:1935	861	62.9%
3/1	Westbound Inner Ahead	U	N/A	N/A	D		1	55	-	323	1912	1306	24.7%
3/2	Westbound Inner Right	O	N/A	N/A	D	E	1	55	34	409	1912	620	65.9%
4/1	Eastbound Inner Ahead	U	N/A	N/A	C		1	55	-	835	1905	1301	64.2%
4/2	Eastbound Inner Right	O	N/A	N/A	C	J	1	55	39	395	1912	604	65.3%
5/1	Haulden Ahead Left	U	N/A	N/A	-		-	-	-	447	1935	1935	23.1%
5/2	Haulden Ahead	U	N/A	N/A	F		1	16	-	164	1935	401	40.9%
6/1+6/2	Boxted Road Left Right	U	N/A	N/A	H	G	1	56:17	39	786	1935:1935	1379	57.0%
7/1		U	N/A	N/A	-		-	-	-	1102	Inf	Inf	0.0%
8/1		U	N/A	N/A	-		-	-	-	589	Inf	Inf	0.0%
9/1		U	N/A	N/A	-		-	-	-	408	Inf	Inf	0.0%
10/1		U	N/A	N/A	-		-	-	-	491	Inf	Inf	0.0%

Full Input Data And Results

Item	Arriving (pcu)	Leaving (pcu)	Turners In Gaps (pcu)	Turners When Unopposed (pcu)	Turners In Intergreen (pcu)	Uniform Delay (pcuHr)	Rand Oversat Delay (pcuHr)	Storage Area Uniform Delay (pcuHr)	Total Delay (pcuHr)	Av Delay Per PCU (s/pcu)	Max Back of Uniform Queue (pcu)	Rand Oversat Queue (pcu)	Mean Max Queue (pcu)
Network	-	-	804	0	0	10.6	5	1.2	17.7	-	-	-	-
Unnamed Junction	-	-	804	0	0	10.6	5	1.2	17.7	-	-	-	-
1/1	396	396	-	-	-	0.0	0.1	-	0.1	1.2	0.0	0.1	0.1
1/2	256	256	-	-	-	2.1	0.9	-	3.0	41.9	5.3	0.9	6.1
2/1+2/2	541	541	-	-	-	2.4	0.8	-	3.2	21.3	5.5	0.8	6.3
3/1	323	323	-	-	-	0.4	0.2	-	0.6	6.8	2.8	0.2	2.9
3/2	409	409	409	0	0	0.4	1.0	0.6	2.0	17.3	1.4	1.0	2.4
4/1	835	835	-	-	-	1.6	0.9	-	2.5	10.7	8.5	0.9	9.4
4/2	395	395	395	0	0	0.6	0.9	0.6	2.1	19.0	2.1	0.9	3.0
5/1	447	447	-	-	-	0.0	0.2	-	0.2	1.2	0.0	0.2	0.2
5/2	164	164	-	-	-	1.3	0.3	-	1.6	35.7	3.2	0.3	3.6
6/1+6/2	786	786	-	-	-	1.8	0.7	-	2.4	11.2	7.9	0.7	8.6
7/1	1102	1102	-	-	-	0.0	0.0	-	0.0	0.0	0.0	0.0	0.0
8/1	589	589	-	-	-	0.0	0.0	-	0.0	0.0	0.0	0.0	0.0
9/1	408	408	-	-	-	0.0	0.0	-	0.0	0.0	0.0	0.0	0.0
10/1	491	491	-	-	-	0.0	0.0	-	0.0	0.0	0.0	0.0	0.0
C1			PRC for Signalled Lanes (%):	36.5	Total Delay for Signalled Lanes (pcuHr):	17.42	Cycle Time (s):	82					
			PRC Over All Lanes (%):	36.5	Total Delay Over All Lanes(pcuHr):	17.70							

Scenario 2: 'New Scenario' (FG2: 'PM', Plan 1: 'Network Control Plan 1')

Stage Sequence Diagram

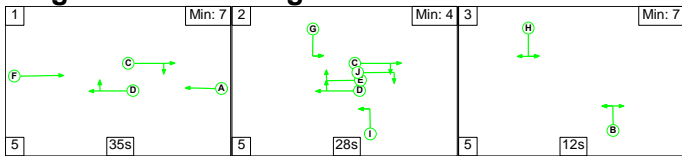

Stage Timings

Stage	1	2	3
Duration	35	28	12
Change Point	0	40	73

Signal Timings Diagram

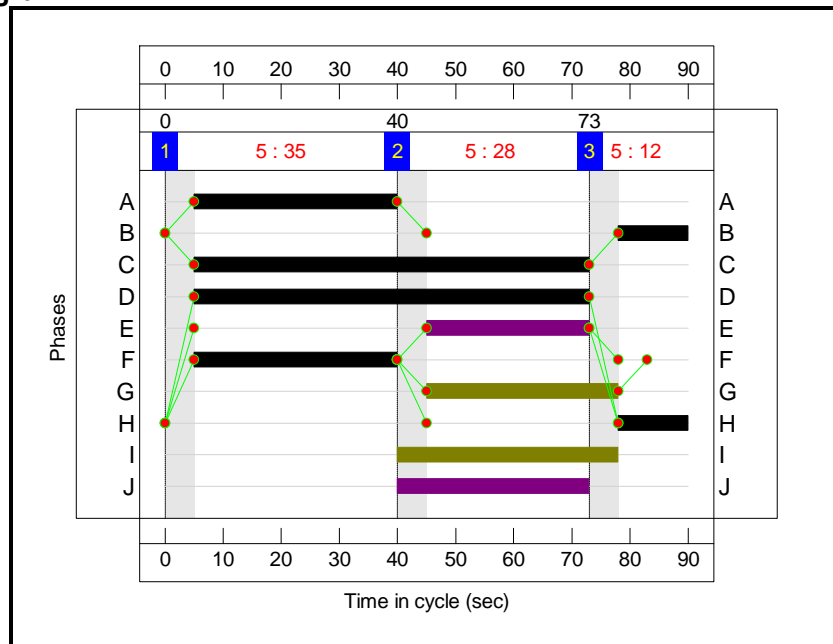

Network Layout Diagram

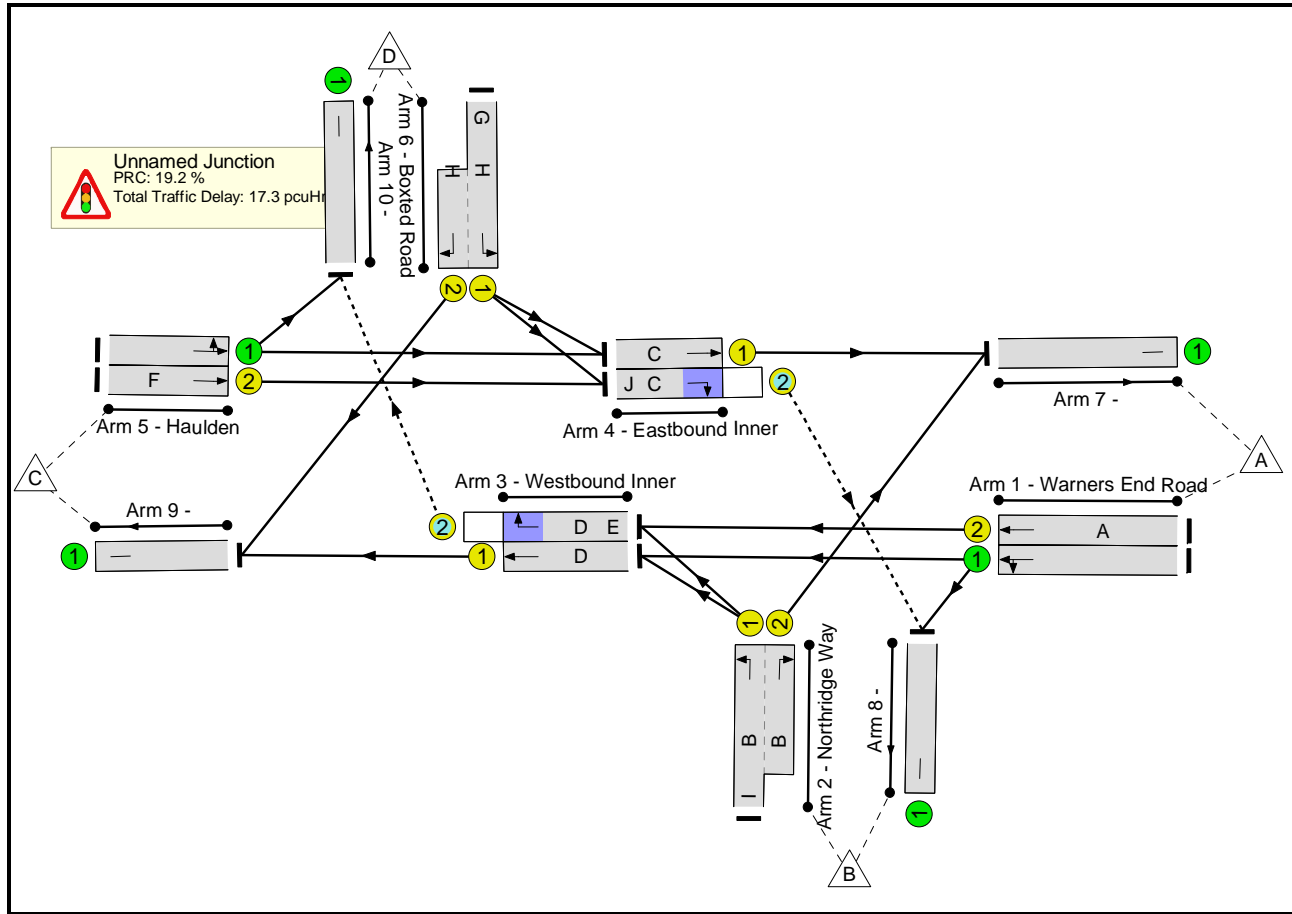

Network Results

Item	Lane Description	Lane Type	Controller Stream	Position In Filtered Route	Full Phase	Arrow Phase	Num Greens	Total Green (s)	Arrow Green (s)	Demand Flow (pcu)	Sat Flow (pcu/Hr)	Capacity (pcu)	Deg Sat (%)
Network	-	-	N/A	-	-		-	-	-	-	-	-	75.5%
Unnamed Junction	-	-	N/A	-	-		-	-	-	-	-	-	75.5%
1/1	Warners End Road Ahead Left	U	N/A	N/A	-		-	-	-	619	1935	1935	32.0%
1/2	Warners End Road Ahead	U	N/A	N/A	A		1	35	-	392	1935	774	50.6%
2/1+2/2	Northridge Way Left Right	U	N/A	N/A	B	I	1	50:12	38	617	1935:1935	817	75.5%
3/1	Westbound Inner Ahead	U	N/A	N/A	D		1	68	-	539	1912	1466	36.8%
3/2	Westbound Inner Right	O	N/A	N/A	D	E	1	68	28	607	1912	807	75.2%
4/1	Eastbound Inner Ahead	U	N/A	N/A	C		1	68	-	504	1905	1461	34.5%
4/2	Eastbound Inner Right	O	N/A	N/A	C	J	1	68	33	249	1912	426	58.5%
5/1	Haulden Ahead Left	U	N/A	N/A	-		-	-	-	329	1935	1935	17.0%
5/2	Haulden Ahead	U	N/A	N/A	F		1	35	-	102	1935	774	13.2%
6/1+6/2	Boxted Road Left Right	U	N/A	N/A	H	G	1	45:12	33	557	1935:1935	1043	53.4%
7/1		U	N/A	N/A	-		-	-	-	715	Inf	Inf	0.0%
8/1		U	N/A	N/A	-		-	-	-	520	Inf	Inf	0.0%
9/1		U	N/A	N/A	-		-	-	-	651	Inf	Inf	0.0%
10/1		U	N/A	N/A	-		-	-	-	730	Inf	Inf	0.0%

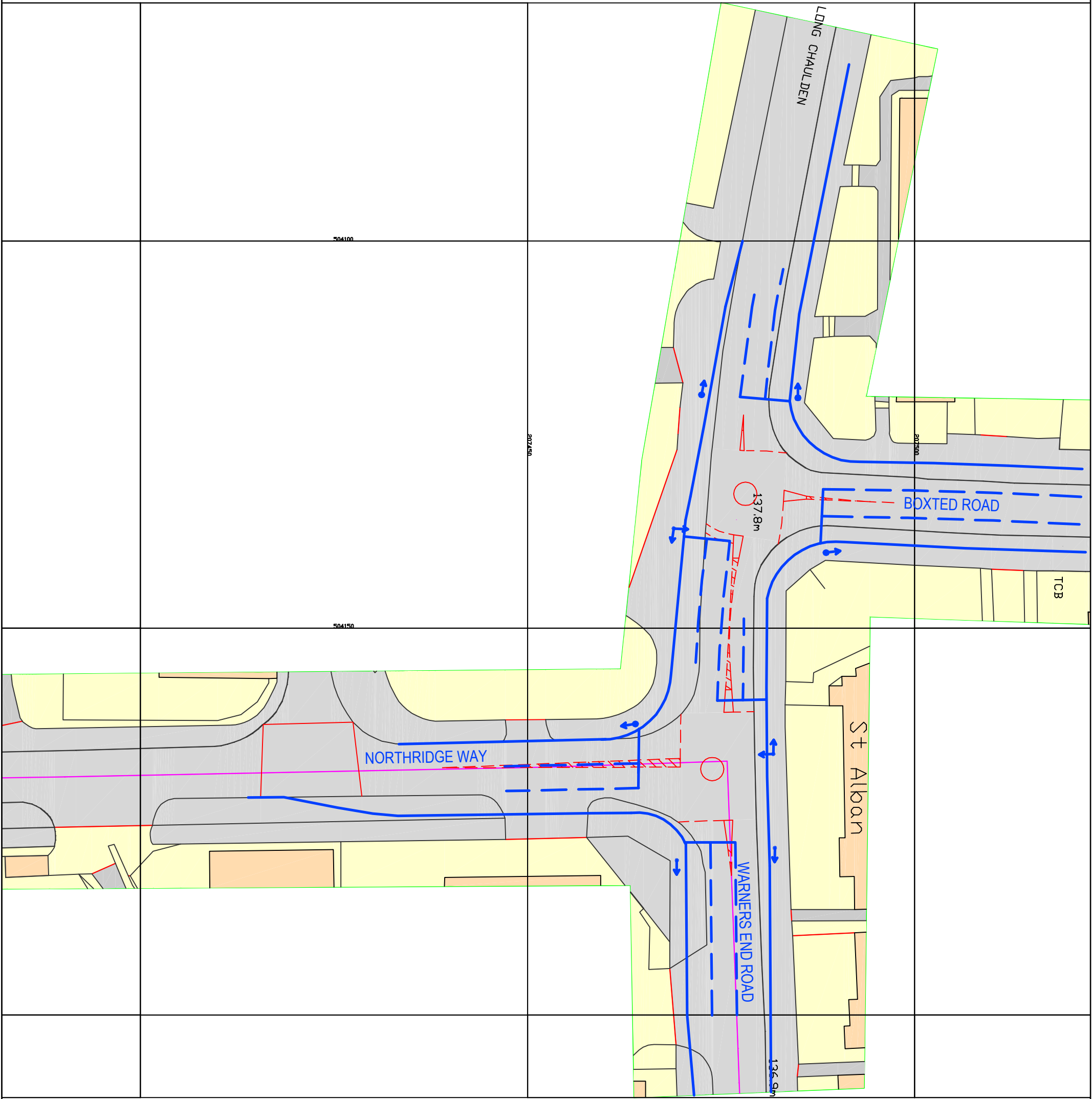

LEGEND

Proposed Improvements



Rev	Description	Revised	Date	Drawn	Checked

stomor
 CIVIL ENGINEERING CONSULTANTS
 Registered Office:
 32 Bevine Lane, Warners Green, Cam,
 Hertfordshire, AL7 4BP
 Design Office:
 19 Millbrook Road, Hemel Hempstead, SG14 4BP
 Tel: 0462 614520
 Email: info@stomor.com www.stomor.com

Project
 Land at Fields End, Hemel Hempstead
Drawing Description
 Junctions Between Long Chaulden, Boxted Road and Northridge Way.
 Existing Layout and Proposed Signalisation
Scale 1:500
Date 13/06/12
Drawn By LAF
Checked By DGS
Client Architect

Drawing Number
 ST-2189-29

Notes
 Do not scale of the drawing.
 Only written dimensions should be taken.
 Any dimensions or notes should be checked for the accuracy of the original drawing.



